



SUBMITTAL DATA



Mounted IDU 20.5 Seer 7 KBTU

Model: TWH07R32AI

Job Name

Location

Date

Purchaser

Engineer

Submitted to

For

Unit Designation

Schedule No.

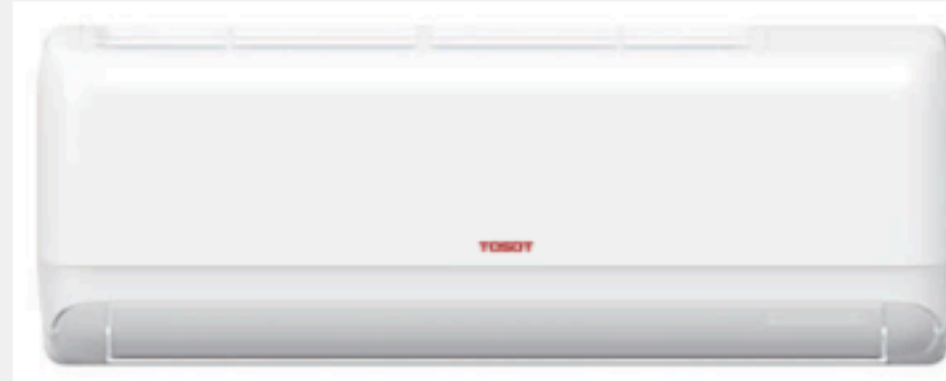

TWH07R32AI

GENERAL FEATURES:

- R32 Refrigerant
- High Efficiency DC Inverter Technology
- Compact and Quiet Design
- Wireless Remote with LCD Display
- Wired Controller Options
- Wi-Fi Included
- Coil (Indoor and Outdoor) Copper Tube / Aluminum Fin
- Blue Colored Fin - 500 Hrs Salt Spray Tested



SPECIFICATIONS & FUNCTIONS:

Model	TWH07R32AI	
Power Supply	VAC / Phase / Hertz	208-230/1/60
Cooling Capacity	Btu/h	7000
Heating Capacity	Btu/h	8000
Air Flow Volume	CFM	247\206\194\182\171\159\135
Sound Pressure Level Cooling	dB (A)	38\35\33\31\29\27\23
Sound Power Level Cooling	dB (A)	48\45\43\41\39\37\33
Sound Pressure Level Heating	dB (A)	38\35\33\31\29\27\23
Sound Pressure Level Heating	dB (A)	24\48\45\43\41\39\37\33
Rated Dehumidification Capacity	L/h	0.6
Dehumidifying Volume	Pint/h	1.27
Fan Type	-	Cross-flow
Fan Diameter-height	mm	φ92×505
Motor Model	-	FN10B-PG
Motor Full Load Amp(FLA)	A	0.4
Cooling Speed	r/min	1150/1000/950/900/850/800/700
Heating Speed	r/min	1150/1000/950/900/850/800/750
Fan Motor Power Output	W	10
Motor ratings (FLA, Horsepower)	hp	0.01
Fan Motor Capacitor	μF	1
Evaporator Material	-	Copper tube-Aluminum fin
Evaporator Face Area	sq.ft	1.45
Evaporator Pipe Diameter	mm	φ7
Evaporator Number of Rows	-	1
Evaporator Tube Pitch(a)×Row Pitch(b)	mm	19.05×12.7
Evaporator Fin Pitch	mm	1.2
Evaporator Fins per Inch(FPI)	-	21
Evaporator L × H × W	mm	508×12.7×267
Evaporator Max. Allowable Pressure	MPa	10
Air Filter	-	PET
Air Filter Size(L×W/NO.)	inch	20 5/7×5 1/5
Gas Pipe(to indoor unit)	inch	3/8"
Liquid pipe	inch	1/4"
Drain Connection (outer diameter)	inch	5/8"
Dimension of Outline	inch	27 56/64× 10 15/64 × 7 18/64
Net Weight	lb	15.4

Functions
Auto
Cooling
Heating
Dehumidify
Air Flow
Three Kinds of Sleep Mode
Vertical Auto Swing
Horizontal Auto Swing
Auto Fan
Quiet
I Feel
Intelligent Preheating
Dry Anti-mildew Design
Several Optional Filters
Auto Clean
Timer Feature
Memory
Chassis Electric Heater Function
Turbo
Temperature
Soft Start
Self-Diagnosis
Lock
WIFI
LCD (Back Light)
LED
Intelligent Defrosting
Force Defrosting
Energy Saving
8°C Heating Mode
Turbo Cooling
Low Ambient Cooling
Low Ambient Heating
Low Voltage Startup
Standby
Multi Speeds

DIMENSIONS & CLEARANCES

INDOOR UNIT:TWH07R32AI

Unit: inch

DIMENSIONS	
W	27-7/8
H	10-1/4
D	7-5/16
W1	3-25/32
W2	18-5/32
W3	5-15/16

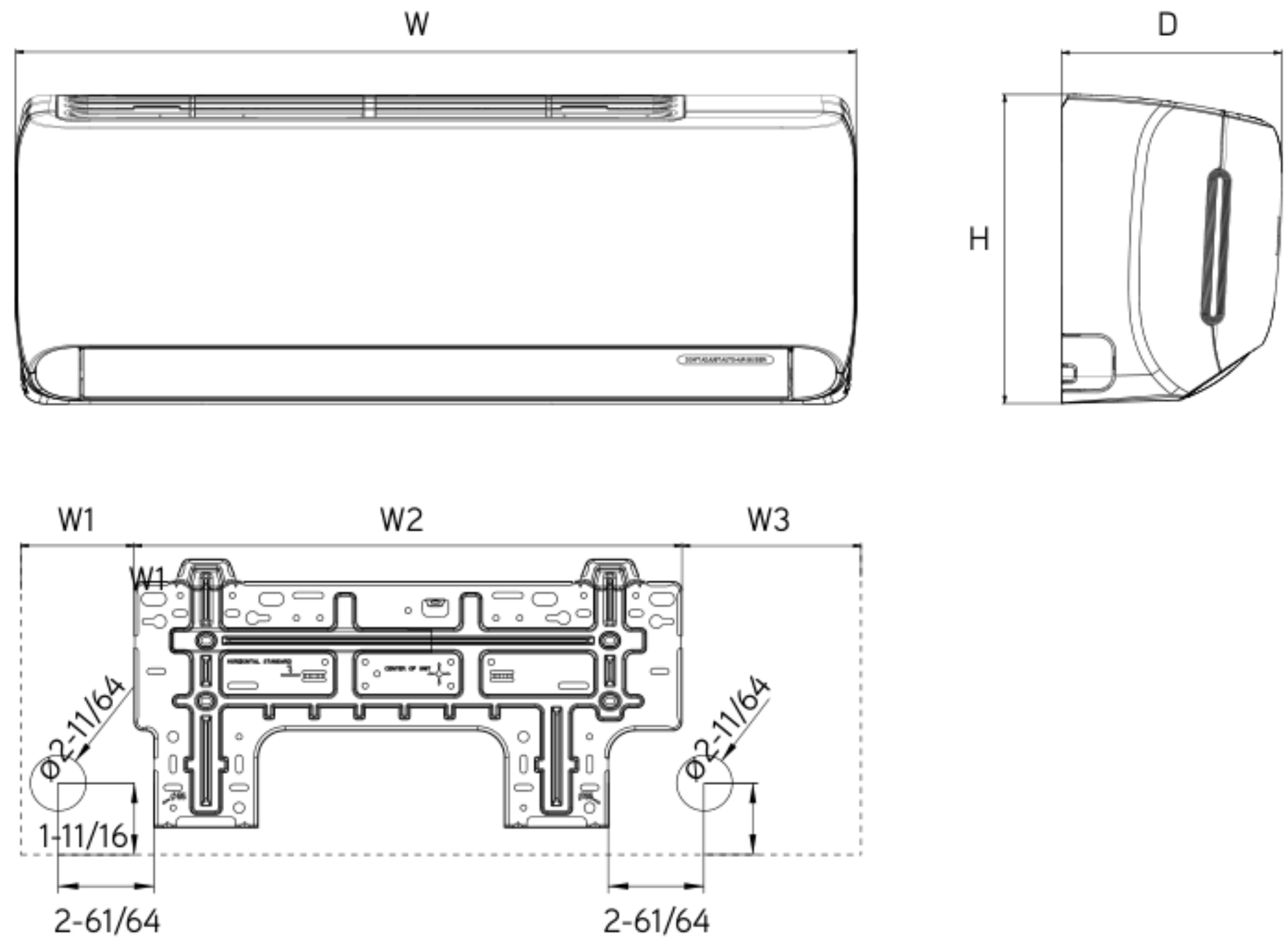

INDOOR UNIT Minimum clearance

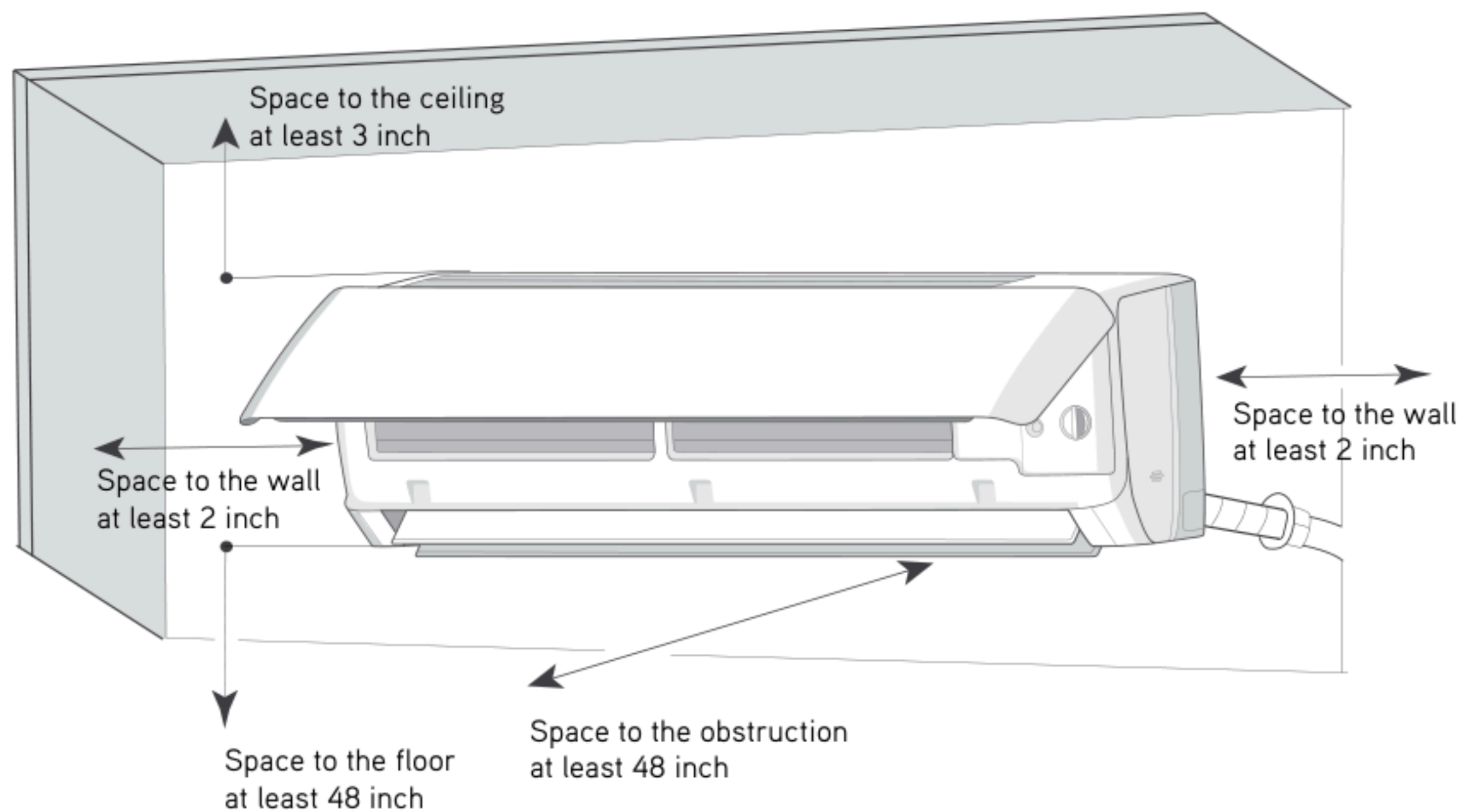

Specifications are subject to change without notice. Manufacturer reserves the right to discontinue or modify specifications or designs without notice or without incurring obligations. All Rights reserved.