

WINDOWS & PATIO DOORS

Product Brochure



(260) 438-9112

www.universalwindowsftwayne.com

1400 C Airport North Office Park, Fort Wayne, IN 46825

BEAUTY & PERFORMANCE

"The installation crew did such a great job installing my new windows! They were on time, polite, and made sure everything was all cleaned up when they were finished. They made the process easy. I highly recommend Universal Windows Direct of Fort Wayne!"

- Johanna P., Auburn, IN



Contents

Message From The Owner	4
Energy Efficiency	5
Window Styles & Features	7
Sliding Glass Patio Doors	11
Options & Upgrades	13
True Lifetime Warranty	17

**You'll Be Saying
"I Love my Windows!"**



(260) 438-9112



www.universalwindowsftwayne.com



**FAMILY
OWNED
SERVICE**

-

**NATIONAL
BRAND
STRENGTH**



A Message from Marc Faylor, Owner

At Universal Windows Direct of Fort Wayne - Faylor Construction Inc., we are proud to be a family owned and operated company serving homeowners throughout Northeast Indiana and Northwest Ohio since 1986.

For nearly four decades, our mission has been simple: to provide homeowners in our own communities with the highest quality home improvement products, expert installation, and the absolute best value we can offer.

As a local company offering nationally backed products and warranties, we are able to give our customers the best of both worlds: the friendly, personal service of a family business combined with the strength, quality, and peace of mind that comes with a national brand.

From windows, roofing, siding, gutters, and doors to kitchen and bathroom remodeling, home additions, and more, our team is committed to helping you improve, protect, and enjoy your home for years to come.

Marc Faylor - Owner
Universal Windows Direct of Fort Wayne
Faylor Construction Inc.



ENERGY EFFICIENCY

High Performance UniShield® Packages

During winter, the inner pane of glass stays warmer to the touch. During the summer, it stays cooler. With better performance overall, you will save money with energy efficient windows, regardless of the season!



UniShield® Classic

- Double coated low-e glass
- Argon filling in air space
- Intercept spacer
- No Warranty



UniShield® Plus

- Double coated low-e glass
- Argon filling in air space
- Provides excellent solar control, UV protection and reduced heating/cooling bills.
- Super Spacer*
- Lifetime Warranty



UniShield® Premium

- Triple-pane unit
- Two pane double coated in low-e glass
- Argon in both air spaces
- Exceptional solar control, UV protection and reduced heating/cooling bills.
- Reduced outside sound transmission
- Super Spacer*
- Lifetime Warranty



UniShield® Supreme

- Triple-pane unit
- Two pane double coated in low-e glass
- Krypton in both air spaces
- Ultimate solar control, UV protection and reduced heating/cooling bills.
- Reduced outside sound transmission
- Super Spacer*
- Lifetime Warranty

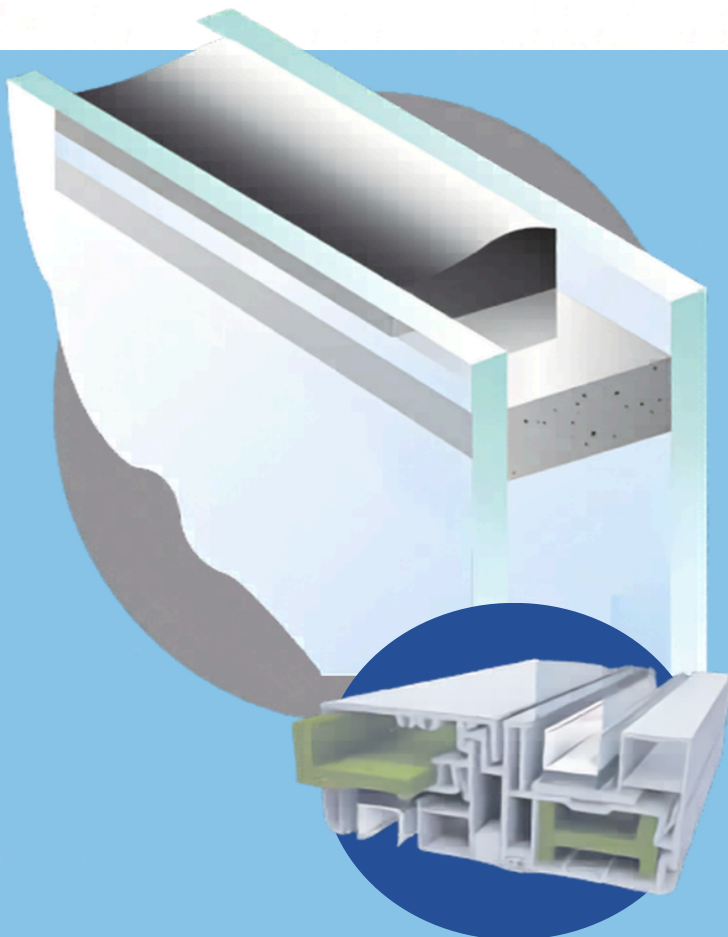

Super Spacer® Reverse Dual Technology



Protects against pests and airborne hazards



Reduce drafts



Lower fuel bills



No maintenance needed

Innergy™ Rigid Thermal Reinforcements

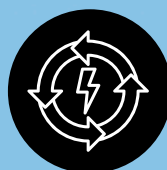

Energy efficient

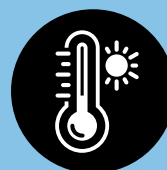

Greater insulation



Tested 700x better than aluminum

A living room with a large window and a beige sofa. The window looks out onto a yard with trees and a fence. The ceiling has a recessed light and a ceiling fan.

WINDOW STYLES & FEATURES

"They replaced all the windows in our home, including an oddly sized one. We were very happy with the work, and the prices. Everyone is very nice at the company. We would hire them again in the future!"

- Holly S., Fort Wayne, IN

Double Hung Features:

- 1 **Tilt Latches** - give the window smoother operation and better performance.
- 2 **Sash Limit Locks** - allow partial opening, providing security from intruders.
- 3 **Groove** - in bottom of sash for vinyl inner sill dam to lock into, creating a secure fit.
- 4 **Extruded Lift Rail** - is part of sash, not added later.
- 5 **Cam-Style Lock** - pulls sashes together for a weather-proof seal while providing security.

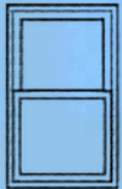

Double Hung

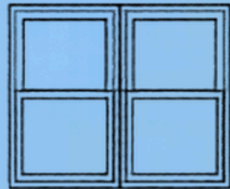

Twin Double Hung



Picture w/
Double Hung
Flankers

Casement, Awning & Hopper

- Cranks, hinges and locks operate effortlessly and are designed with style and strength.
- Casements can be cleaned from inside the home.
- Hinged side of the sash slides away from frame when fully opened.
- Triple seal blocks air & moisture. Multi-point locking system.

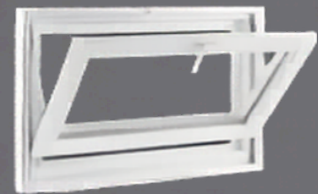

Casement

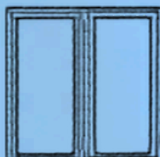

2-lite
Casement

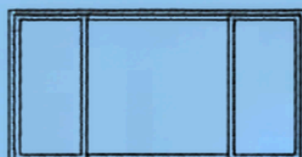

Casement
Picture
Casement



Hopper

Awning

Slider

A slider is like a double hung on its side, with all the advantages of its great ventilation. Brass rollers ensure smooth, quiet operation. Sash lifts out for easy cleaning inside the home. Three light available with operable center or end dash.

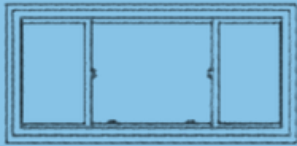

3 Lite
End Vent
1/4 1/2 1/4

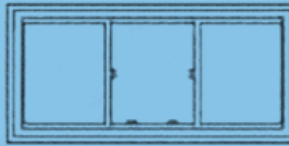

3 Lite
End Vent
1/3 1/3 1/3

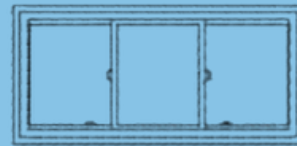

3 Lite
Center Vent
1/3 1/3 1/3

Bay and Bow

The perfect way to expand your living space is to add a bay (top) or bow (bottom) window. You'll appreciate the breathtaking view and you'll take comfort knowing that your bay or bow is also saving money with its energy efficient design.

Available Options:

- Prefabricated roof system to match home's existing roof
- Maintenance free, scratch resistant laminate seat
- Prefinished knee brace
- Recessed lighting, low voltage Halogen



Polished Brass
Clear Lens



Brushed Nickel
Clear Lens



White
Frosted Lens

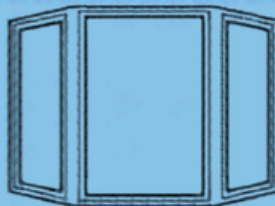

Bay

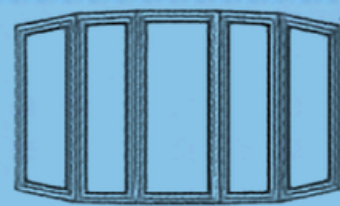

Bow

Additional Styles

Picture Windows

- UniShield® window features
- Maximize glass space
- Can be combined with double hung or casement
- Features Triple Seal System

Garden Windows

- UniShield® window features
- Designed for homeowner with a green thumb
- Cranks, hinges and multipoint locking system
- Hinged sashes for easy cleaning
- Features Triple Seal System

Specialty Shaped Windows

- UniShield® window features
- Octagon, trapezoid or arch
- Enhance aesthetic of home
- Completely customizable
- Features Triple Seal System

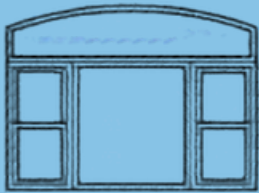

**Extended Leg
Eyebrow Picture
Double Hung
Flankers**



**Mullied
Casements &
Trapezoids**



Eyebrow

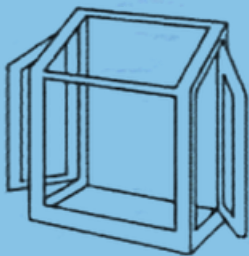

**Garden
Window**



**Twin Double
Hung & Half
Round Transom**



Pentagon



**Extended Leg
Half Round**

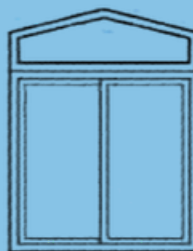

**2-lite Glider &
Pentagon Transom**



Octagon



SLIDING GLASS PATIO DOORS

"I purchased a patio door with internal venetian blinds & I love it! The blinds keep the sun out, without the worry of having the cat or dog brush into them. The installers were fantastic, and explained everything to me. Couldn't be happier!"

- Connie C., Fort Wayne, IN

Standard Sliding Glass Patio Door

The UniShield® vinyl sliding glass patio door delivers everything you would expect from a patio door: beauty, elegance, energy efficiency, low or no maintenance, and the latest in gliding door technology. Whether you're building or replacing, look into a sliding glass door and feel secure about your choice.



Tan



White



Brown

Standard handle comes in tan, white or brown coppetone for woodgrains.

UPGRADE HANDLE OPTIONS



Black



Satin Nickel



Polished Brass



Antique Brass



Aged Bronze

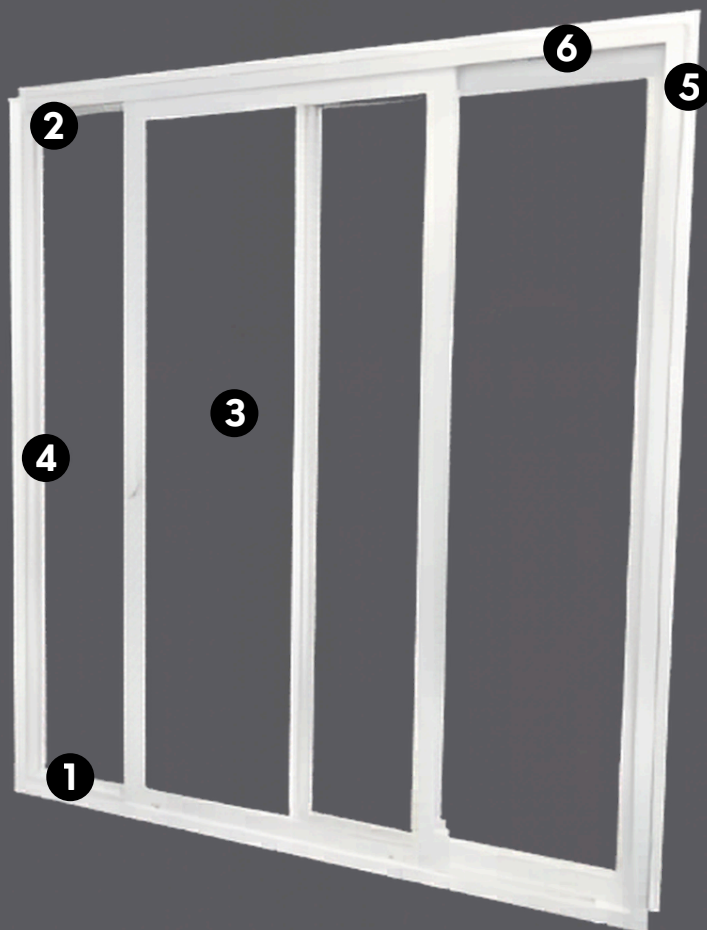

Sliding Door Features:

- 1 Double Weather-Stripping where door panel meets main frame, and where door panels interlock.
- 2 Fusion Welding at door panel corners transform four extrusions into a strong, efficient one-piece door construction.
- 3 Safety Glass for strength and safety.
- 4 Injected Foam Filling in the vertical main frame extrusions expands to add both rigidity and insulating value. Saves money on heating and cooling bills all year-round.
- 5 Vertical Main Frame & Door Panel Extrusions reinforced with aluminum.
- 6 Sloped, Aluminum Reinforced sill guides rainwater outside and away.



Two Panel



Three Panel

A bright sunroom with large windows, a chandelier, and a dining table. The room features a wooden floor, a grey patterned rug, and a dining table with a black metal frame. A chandelier hangs from the ceiling, and a sign above the windows reads "Bless this Home with Love & Laughter".

OPTIONS & UPGRADES

"These guys are top notch. We needed all the windows replaced in our Sun Room. They were fast, efficient, and I was really impressed with the quality of the workmanship.

- Sara C., Huntertown, IN

Color and Paint Options

Worried that replacement windows won't mesh with the exterior and interior colors of your home? We have a plethora of colors to choose from, allowing you to mix and match vinyl colors, exterior paints, exterior laminates and interior wood-grains to create your perfect window!

Vinyl window colors are added at the factory, not painted on at the home after installation! Standard white or tan vinyl is part of the window frame itself, while upgraded exterior colors are factory-applied as either a durable PVC paint finish or a bonded laminate.

Interior woodgrain finishes are also laminated onto the vinyl.

* Colors are close approximations. True colors displayed on material swatch palette.

VINYL COLOR OPTIONS

(Hardware matches vinyl)

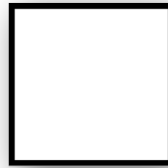

White

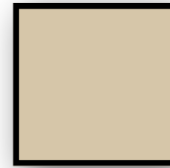

Tan



Black

INTERIOR WOODGRAIN OPTIONS



Medium Oak



Dark Oak

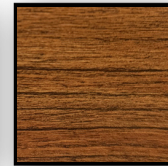

Cherry



Vintage Pecan

EXTERIOR PAINT OPTIONS



White



Gray



Beige



Tan

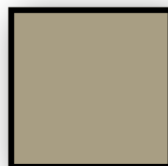

Clay



Architectural
Bronze



Green



Brick Red

EXTERIOR LAMINATE OPTIONS



Wicker



Choco Brown

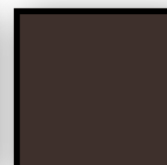

Bronze

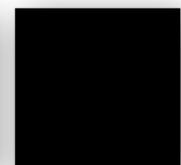

Black

Decorative Glass Options

Why not add a little flair to your new windows and customize them with one of our grid styles and/or glass views? We offer a wide variety of decorative etched glass options and in-window gridding systems that are sure to fit any home's style. Our in-window systems and etched glass options are custom-installed at the factory, ensuring perfect placement and installation every time.

All of our products are scrutinized under extreme weather conditions and structural stresses. Top quality and integrity are insured with all of our products.

PLATED LOCK FINISHES

Available in the Double-Hung, Slider, 3-Lite Slider & Casement Windows



Antique Brass

Satin Nickel

Polished Brass



Aged Bronze

Copper-tone
(Standard hardware
with woodgrain
interior finish)

COLONIAL GLASS OPTIONS



Flat



Contour

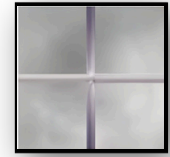

View

PRAIRIE GLASS OPTIONS



Flat



Contour

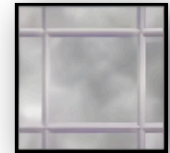

View

DOUBLE COLONIAL GLASS OPTIONS



Flat

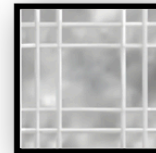

Contour



View

PERIMETER PRAIRIE GLASS OPTIONS

Top sash pictured (bottom sash reflects top)



Flat



Contour

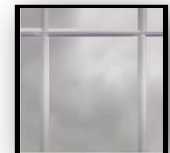

View

OBSCURE GLASS OPTIONS



Standard



Glue Chip

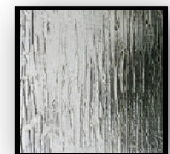

Rain Glass

VIEW (ETCHED) GLASS OPTIONS



Floral



Elongated Floral



**CUSTOMIZE
EVERY
DETAIL**

**-
LOVE
EVERY
VIEW**



TRUE LIFETIME WARRANTY

"The team at Universal Windows Direct of Fort Wayne is easy to work with and treated us like family. Prices were comparable, and made me not feel like I was being taken advantage of like some other places did."

- Tina S., Kendallville, IN

True Lifetime Warranty

Universal Windows Direct of Fort Wayne warrants its products for as long as the original purchaser owns the property on the following components:



Pieces, parts
and materials



Glass system
and frames



All locks and
hardware



All installation
and labor

Terms and Conditions

We proudly back our products with an outstanding warranty service, even long after the completion of the home improvement project. Warranties from Universal Windows Direct are 100% non pro-rated and 100% trans-ferable to a subsequent homeowner for a period of 30 years. Before contacting us about warranty replacement, please be prepared to provide a detailed explanation of the damaged product. Please note that the True Lifetime Warranty does not include defects resulting from abuse, misuse, neglect, vandalism or acts of nature. In the event that defects in the product appear within the warranty constraints, no service costs will ever be charged.

Should you find yourself experiencing defects with any of our products, please don't hesitate to reach out to us. Our committed team is ready to assist you to the best of our abilities.

We thank you for choosing Universal Windows Direct for your home im-provement needs and look forward to doing future business with you.

Questions? Contact us.

 (260) 438-9112

 www.universalwindowsftwayne.com

FAMILY OWNED & OPERATED

***Universal
Windows***

Direct

OF FORT WAYNE



**SET UP YOUR FREE,
NO-OBLIGATION ESTIMATE TODAY!**

(260) 438-9112

www.universalwindowsftwayne.com

1400 C Airport North Office Park, Fort Wayne, IN 46825

WHAT DO WE SPECIALIZE IN?

Windows - Asphalt & Metal Roofing - Siding
Patio & Entry Doors - Gutters - Gutter Protection
Kitchen & Bathroom Remodeling - Construction