

**KÄRCHER**

# COMPLETE CATALOG

Professional Pressure Washers,  
Genuine Kärcher Parts,  
Pressure Washer Parts,  
Accessories & Detergents

PROFESSIONAL | 2023

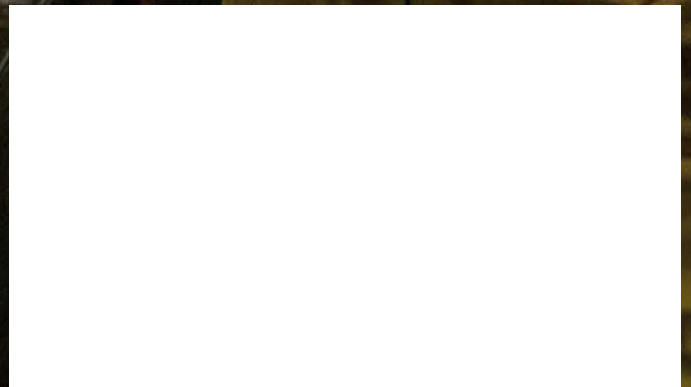

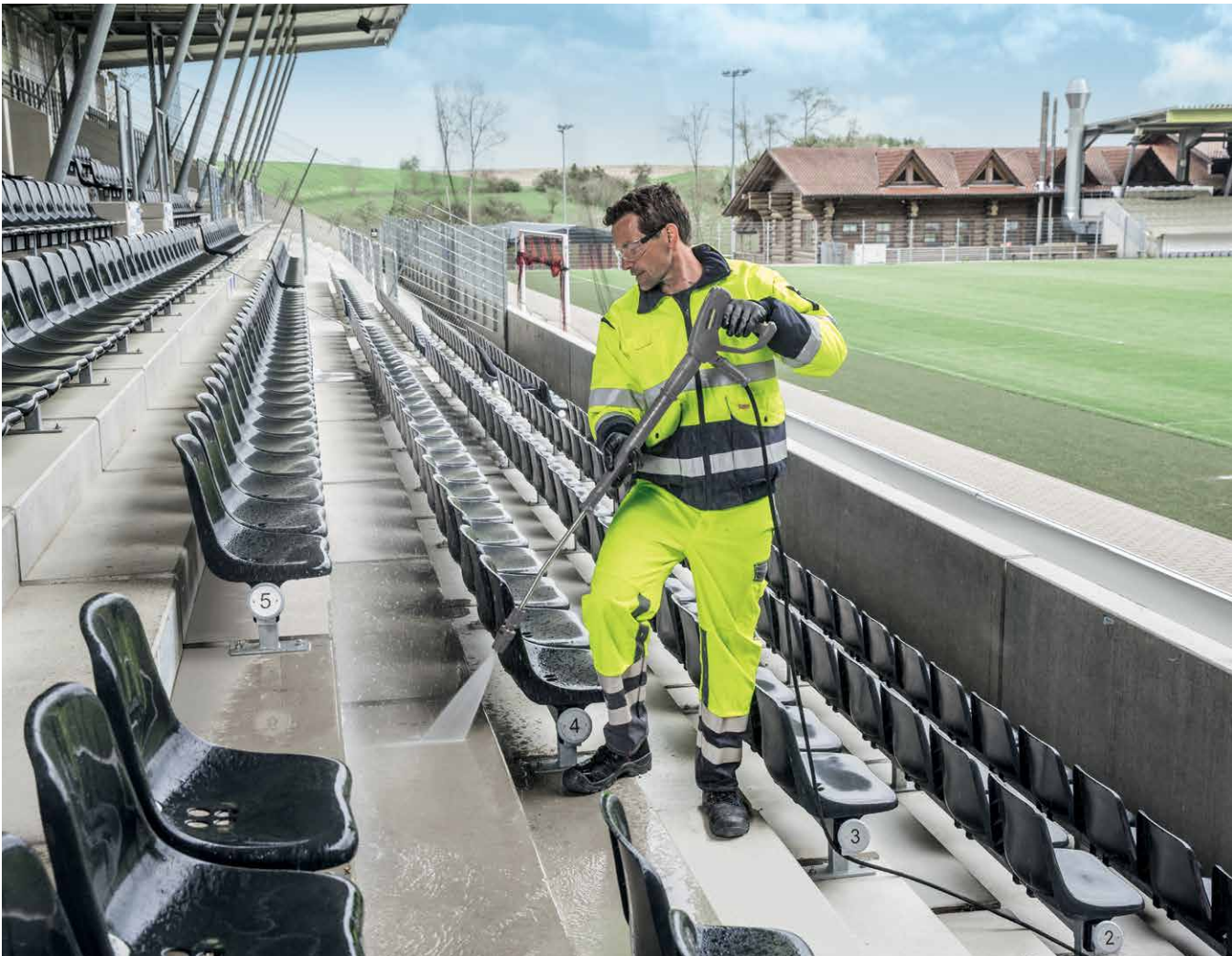

## VALUE ADDED ICONS

Throughout the following pages, look for these icons displayed with each Kärcher machine. Find out what makes our professional cleaning equipment some of the most innovative and sought after equipment in the industry.



Tested by a Nationally Recognized Testing Laboratory (NRTL) and meets safety standards.



Most Kärcher pumps come with a 7-year warranty, wear parts excluded.



Puncture proof, flat free tires.



Many Kärcher German machines can be operated using environmentally friendly biodiesel.



Easy Operation dial provides self-explanatory symbols to identify cleaning modes.



Lithium Ion battery offering a longer life than other batteries, consistent voltage, and energy charging savings.



International (Canadian Standards Association) tests and certifies electrical, mechanical, plumbing and gas of products.



Economical and environmental mode for reducing energy consumption while still offering optimal cleaning performance.



Trigger gun uses the recoil force of the high-pressure spray to reduce the hold force of the trigger to zero.



Quick lock screw connection for pressure washers and accessories.



Automatically shuts down the motor and pump when the trigger gun is released.



FACT - Flexible Application Control Technology allows adjustment of brush speed for different applications.



Leadership in Energy and Environmental Design and is widely used green building rating system.



National Association of Trailer Manufacturers that provides applicable Federal Motor Vehicle Safety Standards for members.



Electric start of motor for convenience of easier and faster start-up.



Pressure and water flow regulation directly at the gun.



Two-way dosing valve for switching between different detergents and for precise and variable cleaning agent dosing.



## TABLE OF CONTENTS

Find your equipment, detergents, parts and accessories.

KÄRCHER PRESSURE WASHERS	2	NOZZLES	189
KÄRCHER WATER RECOVERY	39	PUMPS & PUMP KITS	207
KÄRCHER FLOOR CARE	40	UNLOADERS, INJECTORS, VALVES & GUAGES	239
KÄRCHER DETERGENTS	78	ENGINES, MOTORS & PULLEYS	264
KÄRCHER PARTS & ACCESSORIES	89	BURNERS	272
PRESSURE WASHER ACCESSORIES	136	ELECTRICAL COMPONENTS	288
GUNS & LANCES	152	CHASSIS COMPONENTS	302
HOSES	161	CAR WASH BAY ACCESSORIES	305
COUPLERS, FITTINGS & FILTERS	171	AG SPRAY ACCESSORIES	312

# HDS UPRIGHT CLASS



## Mobility at its finest.

This high-performance, robust upright machine offers outstanding maneuverability, easy transport and intuitive operation. Ideal for tradesmen, commercial use and contract cleaners.



## Features

- Effortless transport over landings or stairs and space saving storage
- Large, flat-free tires for unpaved surfaces
- Large fine mesh filter reliably protects against dirt particle damage
- Easy!Force gun with cruise control like technology - uses its own recoil force to hold the trigger down – so no more sore hands after hours of use

## TECHNICAL DATA

Model	Part No.	GPM	PSI	Drive	HP	Electrical	Amps	Pump	Ship Weight (lbs)	Ship Dimensions (L x W x H) Inches
HDS 1.7/12 U Ed	1.064-907.0	1.7	1200	Direct	2.3	110-120V / 1ph	12.5	Kärcher Axial	178	28 x 28 x 46

## ACCESSORIES

Order No.	Description
■ 4.118-005.0	■ EASY!Force trigger gun (German model) - zero force required.
■ 4.112-006.0	■ 33" spray lance
■ 6.110-034.0	■ 33' high-pressure hose
■ 4.117-027.0	■ Triple jet nozzle, 032
□ 2.112-015.0	■ Gutter cleaning lance
□ 4.112-032.0	■ Underbody lance
□ 6.110-051.0	■ High-pressure hose, 33', 10m DN8, suitable for food industry, extension piece
□ 6.110-049.0	■ Pipe cleaning hose
□ 2.111-013.0	■ FR 30 ME surface cleaner
□ 2.111-011.0	■ Surface cleaner FR 30
□ 4.115-000.0	■ Wet blasting attachment
□ 4.113-003.0	■ Rotating washing brush natural fiber bristles
□ 4.113-004.0	■ Rotating washing brush nylon bristles
□ 2.113-000.0	■ Power nozzle 25° spray angle
□ 4.114-019.0	■ Dirtblaster Nozzle 035
□ 4.637-033.0	■ Detergent injector for high pressure
□ 2.115-000.0	■ Quick coupling
□ 2.115-001.0	■ Plug nipple
□ 4.112-000.0	■ 41" Spray lance

■ Included □ Optional ■ Compatible with EASY!Lock

## HDS COMPACT CLASS



### It's all in the detail.

Kärcher's German-built electric hot water machines are the most advanced on the market, featuring Kärcher's patented axial pump integrated with a 2-pole motor for optimum efficiency. Kärcher's efficient and compact downdraft-fired burner uses far less fuel than standard heat exchangers. Units come standard with low-fuel shut-off, low-water protection, high-temperature shut-off, thermal overload protection, EASY!Force gun, and 50' hose. All units are certified ETL safety standards.



### Features

- eco!efficiency mode – economical and environmentally friendly, even during longer periods of use, and this mode reduces fuel consumption and CO2 emissions by 20%
- Robust wheels and steering mechanism for maneuverability
- Large integrated handles in the chassis
- Integrated tilting aid for effortlessly negotiating obstacles such as steps and curves

### TECHNICAL DATA

Model	Part No.	GPM	PSI	Drive	HP	Electrical	Amps	Pump	Ship Weight (lbs)	Ship Dimensions (L x W x H) Inches
HDS 2.3/12 C Ed	1.272-901.0	2.3	1100	Direct	2.8	110-120V / 1ph	18.5	Kärcher Axial	270	40 x 28 x 41

### ACCESSORIES

Order No.	Description
■ 4.118-005.0	■ EASY!Force trigger gun (German model) - zero force required.
■ 4.112-000.0	■ 41" spray lance
■ 6.110-030.0	■ High pressure hose, 50', both sides Easy!Lock, ID 8
■ 4.117-037.0	■ Triple jet nozzle, 050 (for machine 1.272-901.0)
□ 4.111-041.0	■ Adapter for Easy!Force trigger gun connection to 3/8" hose

■ Included □ Optional ■ Compatible with EASY!Lock

# MOJAVE SERIES



Premium model pictured



## Robust and innovative.

The Kärcher Mojave series is the perfect all-around machine for a variety of applications and target groups, including agriculture, automotive and transportation industries. The machines deliver the highest performance for best cleaning results - all combined in a robust package. The components include unique features in the market and combine it with high quality components engineered for a high product lifetime.



## New, innovative, features and upgrades

- Standard auto start/stop
- Equipped with EASY!Force accessories, hour meter, status LED, crane hook, and other upgraded features
- Steam stage, Servo Control, and stainless steel side panels included on Premium units

## TECHNICAL DATA

Model	Part No.	GPM	PSI	Motor	Electrical	Amps	Steam Mode	Pressure Adjustment	Ship Weight (lbs)	Ship Dimensions (L x W x H) Inches
HDS 2.2/12 Ed Standard	1.109-151.0	2.2	1200	2-pole	120V / 1ph	20	No	-	397	50 x 40 x 50
HDS 3.0/20-4 Ea/Eg Standard	1.109-153.0	3.0	2000	4-pole	208-230V / 1ph	26	No	At unloader	507	50 x 40 x 50
HDS 3.5/30-4 Ea Standard	1.109-155.0	3.5	3000	4-pole	230V / 1ph	35	No	At unloader	507	50 x 40 x 50
HDS 3.5/30 Eg Standard	1.109-154.0	3.5	3000	4-pole	230V / 1ph	35	No	At unloader	550	50 x 40 x 50
HDS 4.0/20 Eg Premium	1.109-156.0	4.0	2000	4-pole	230V / 1ph	30	Yes	Servo Control	550	50 x 40 x 50
HDS 4.0/20-4 Ea Premium	1.109-157.0	4.0	2000	4-pole	230V / 1ph	30	Yes	Servo Control	550	50 x 40 x 50
HDS 4.0/20-4 Eh/Eb Premium	1.109-158.0	4.0	2000	4-pole	208-230V / 3ph	24	Yes	Servo Control	550	50 x 40 x 50
HDS 4.0/20-4 Ec Premium	1.109-159.0	4.0	2000	4-pole	460V / 3ph	12	Yes	Servo Control	550	50 x 40 x 50
HDS 4.0/30-4 Eh/Eb Premium	1.109-163.0	4.0	3000	4-pole	208-230V / 3ph	30	Yes	Servo Control	550	50 x 40 x 50
HDS 4.0/30-4 Ec Premium	1.109-164.0	4.0	3000	4-pole	460V / 3ph	14	Yes	Servo Control	550	50 x 40 x 50
HDS 4.0/30-4 Ef Premium	1.109-165.0	4.0	3000	4-pole	575V / 3ph	12	Yes	Servo Control	550	50 x 40 x 50
HDS 5.0/30-4 Eh/Eb Premium	1.109-166.0	5.0	3000	4-pole	208-230V / 3ph	34	Yes	Servo Control	550	50 x 40 x 50
HDS 5.0/30-4 Ec Premium	1.109-167.0	5.0	3000	4-pole	460V / 3ph	16	Yes	Servo Control	550	50 x 40 x 50
HDS 5.0/30-4 Ef Premium	1.109-168.0	5.0	3000	4-pole	575V / 3ph	13	Yes	Servo Control	550	50 x 40 x 50

## ACCESSORIES

Order No.	Description
■ 4.118-005.0 ■	EASY!Force trigger gun (German model) - zero force required
■ 4.112-000.0 ■	41" spray lance
■ 6.110-029.0 ■	50' EASY!Lock Longlife hose with ANTI!Twist connection (included on premium units)
■ 6.110-030.0 ■	50' EASY!Lock hose with ANTI!Twist connection (included on standard units)
■ 2.113-007.0 ■	Power nozzle 25042 for HDS 3.0/20-4 Ea/Eg
■ 2.113-021.0 ■	Power nozzle 25040 for HDS 3.5/30-4 Ea
■ 4.115-020.0 ■	Power nozzle 25058 for HDS 4.0/20-4 Ea Premium
■ 2.114-008.0 ■	Steam nozzle (included on HDS 4.0/20-4 Ea)
■ 4.118-008.0 ■	Servo Control dial (included on HDS 4.0/20-4 Ea)
□ 8.750-685.0	100' pivot reel
□ 9.808-276.0	Hose reel bracket kit (hose reel not included)

■ Included □ Optional ■ Compatible with EASY!Lock

# HDS SUPER CLASS



## Full-size power.

Super class hot water pressure washers offer optimum cleaning performance, easy handling and the latest technology.

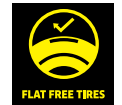

## Features

- Service switch offers a choice of five settings to suit local water hardness. This allows optimum metered quantities of anti-scaler and corrosion inhibitor to be added to the water supply, and prevents the buildup of lime scale on the heater coil. Operating data can be called up any time, allowing you to make continual adjustments
- Kärcher burner technology not only translates to more economical operation, but also makes our hot water pressure washers trendsetters in environmental protection thanks to their low emissions and highly efficient operation

## TECHNICAL DATA

Model	Part No.	GPM	PSI	Drive	HP	Electrical	Amps	Pump	Ship Weight (lbs)	Ship Dimensions (L x W x H) Inches
HDS 5.0/30-4S Eb	1.071-919.0	2.4-5.0	460-3000	Direct	11	208-240V / 3ph	27	Kärcher Axial	516	51 x 32 x 45
HDS 5.0/30-4S Ec	1.071-920.0	2.4-5.0	460-3000	Direct	11	460-480V / 3ph	15	Kärcher Axial	516	51 x 32 x 45

## ACCESSORIES

Order No.	Description
■ 4.118-005.0 ■	EASY!Force trigger gun (German model) - zero force required.
■ 4.112-000.0 ■	41" spray lance
■ 6.110-029.0 ■	50' EASY!Lock Longlife hose with ANTI!Twist connection
■ 2.113-012.0 ■	Power nozzle, 062
□ 4.111-041.0 ■	Adapter for EASY!Force trigger gun connecting to 3/8" hose
□ 4.118-009.0 ■	Servo control
□ 8.750-685.0	100' pivot reel
□ 8.921-775.0	Hose reel bracket (complete with Easy!Lock adapter, street elbow and 6' jumper hose)

■ Included □ Optional ■ Compatible with EASY!Lock

# HDS SPECIAL CLASS



## The zero emission specialist.

The emission-free HDS-E 3.3/25-4M Ec with electric heater is ideal where exhaust gases are undesirable or prohibited. Thanks to the unique type of heater insulation and Kärcher ecoefficiency mode, the HDS-E 3.3/25-4M Ec is efficient and eco-friendly. Models are certified to ETL safety standards.

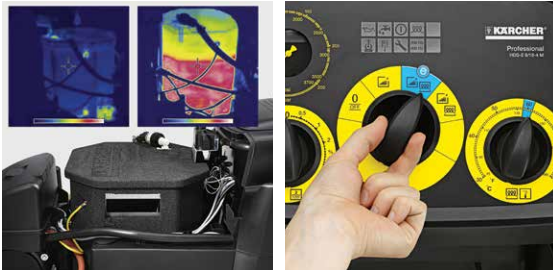

## Features

- eco!efficiency mode – economical and environmentally friendly, even during longer periods of use
- Intuitive operation with large single-button selector dial

## TECHNICAL DATA

Model	Part No.	GPM	PSI	Drive	HP	Electrical	Amps	Pump	Ship Weight (lbs)	Ship Dimensions (L x W x H) Inches
HDS-E 3.3/25-4M Ec	1.030-902.0	1.6-3.3	465-2520	Direct	7.5	460V / 3ph	35	Kärcher Axial	290	50 x 32 x 45
HDS-E 3.3/25-4M Ef	1.030-903.0	1.6-3.3	465-2520	Direct	7.5	575V / 3ph	28	Kärcher Axial	352	50 x 32 x 45

## ACCESSORIES

Order No.	Description
■ 4.118-005.0	■ EASY!Force trigger gun (German model) - zero force required.
■ 4.112-000.0	■ 41" spray lance
■ 6.110-030.0	■ 50' EASY!Lock Longlife hose with ANTI!Twist connection
■ 2.113-009.0	■ Power nozzle, TR 25047
□ 2.111-013.0	■ Surface cleaner, FR 30 ME
□ 4.111-037.0	■ Coupler
□ 4.118-007.0	■ Servo Control
□ 4.111-036.0	■ Adapter for EASY!Lock lance connecting to M18 Dirtblaster nozzle
□ 4.111-041.0	■ Adapter for EASY!Lock gun connecting to 3/8" hose
□ 8.750-685.0	■ 100' pivot reel
□ 8.921-775.0	■ Hose reel bracket (complete with Easy!Lock adapter, street elbow and 6' jumper hose)

■ Included □ Optional ■ Compatible with EASY!Lock



# HDS CABINET



## Cleaning technology for indoors.

This Kärcher all-electric hot water pressure washer introduces hot-water tank technology to deliver hot water on demand ideal for indoor cleaning. Water is heated by flowing through a coil inside an 80-gallon water tank. Heating elements generate 138,000 BTU to produce hot water of up to 180°F. All models are certified to ETL safety standards.



## Features

- Heavy-duty, steel cabinets are protected by an epoxy powder coat finish; upper cabinet ventilated for cool operation
- Thermal pump saver valve prevents damage by venting recirculated water
- Low-water flow switch prevents damage to heating elements due to lack of water
- Easy-to-attach detergent injector and three quick couplers nozzles
- Auto start function allows unit to be turned on with pull of the trigger
- EASY!Force gun with cruise control like technology - uses its own recoil force to hold the trigger down - so, no more sore hands after hours of use

## TECHNICAL DATA

Model	Part No.	GPM	PSI	Drive	HP	Electrical	Amps	Pump	Ship Weight (lbs)	Ship Dimensions (L x W x H) Inches
HDS 4.0/20 E Ec	1.109-075.0	4.2	2000	Belt	6.2	460V / 3ph	55	Kärcher KM	640	32 x 24 x 52
HDS 4.0/30 E Ec	1.109-076.0	3.5	3000	Belt	7.5	460V / 3ph	59	Kärcher KM	640	32 x 24 x 52
HDS 4.0/20 E Ef	1.109-956.0	3.5	2000	Belt	5	575V / 3ph	46	Kärcher KM	620	34 x 25 x 52
HDS 4.0/30 E Ef	1.109-957.0	3.5	3000	Belt	7.5	575V / 3ph	49	Kärcher KM	640	34 x 25 x 52

## ACCESSORIES

Order No.	Description
■ 8.756-481.0	EASY!Force trigger gun (North American Model) - zero force required. Standard 1/4" connection for wand, 3/8" connection for hose.

## OPTIONS (FACTORY INSTALLED)

Order No.	Description
<input type="checkbox"/> 8.925-520.0	Time delay shutdown (replaces auto start-stop) (only for 460V units)
<input type="checkbox"/> 9.801-002.0	Pressure washer stainless steel cabinet (only for 460V units)

■ Included  Optional  Please Note: NOT compatible with EASY!Lock

# SECHURA SERIES



## High cleaning performance.

The North American Kärcher HDS natural gas and LP-heated cabinet pressure washer delivers up to 9.5 gpm at 3000 psi of industrial power. Built in the U.S.A., each model is constructed with anodized structural rivets, industrial motors and Kärcher pumps that are backed by a 7-year warranty.



## Features

- All-access cabinet design with six lift out panels and easy lock fasteners provides easy access to components for maintenance in tight situations
- Swing-out cast iron burner ring with separate “stay-in-place” ignition pilot light allows easy access and removal of the burner ring
- Improved “Stay-Tite” belt tensioning system maintains belt tension on the pump with a torsion bar for precise tension adjustment
- The heating coil is made of leak-free, cold rolled, schedule 80 steel pipe and is wrapped with a thick foil blanket insulation that keeps cabinet walls cool to the touch
- EASY!Force gun with cruise control like technology - uses its own recoil force to hold the trigger down - so, no more sore hands after hours of use

## ACCESSORIES

Order No.	Description
■ 4.118-005.0 ■	EASY!Force trigger gun (German model) - zero force required.
□ 8.917-509.0	Kit, wireless remote pump/burner/detergent
□ 8.921-832.0	Wireless hand-held transmitter
□ 8.917-817.0	Kit, wall bracket wireless transmitter
□ 8.921-774.0	NG kit, wired remote station - pump and burner (note: cord length is 20 ft)
□ 8.921-773.0	NG kit, wired remote detergent
□ 8.922-157.0	Remote control box (wired) (Pump / burner switch Included, add 8.921-773.0 for detergent switch). For additional remote only.
□ 8.917-507.0	Snap-N-Go Auto Start/Stop Kit w/ Lock Out (no remote, or wireless remote)
□ 9.807-646.0	Snap-N-Go Auto Start/Stop Kit w/o Lock Out (wired remote, requires 8.921-774.0)
□ 8.917-508.0	Snap-N-Go Time Delay Kit
□ 8.921-776.0	Kit, steam combo
□ 9.801-040.0	Draft diverter, 10", up to 5 gpm
□ 8.717-730.0	Draft diverter, 12", over 5 gpm
□ 8.753-474.0	Draft damper, 10"
□ 8.753-478.0	Draft damper, 12"
□ 8.753-706.0	Reducer, stack 12" to 10"
□ 8.753-707.0	Reducer, stack 10" to 8"
□ 8.923-213.0	Outlet relocater

■ Included □ Optional ■ Compatible with EASY!Lock

# SECHURA - NG

## TECHNICAL DATA

Model	Part No.	GPM	PSI	Drive	HP	Electrical	Amps	Pump	Ship Weight (lbs)	BTU	Ship Dimensions (L x W x H) Inches
<b>Natural Gas-Heated 3.5-5.0 GPM Medium Cabinet Design</b>											
HDS 3.5/20 Ea ST NG	1.109-715.0	3.5	2000	Belt	5	230V / 1ph	25	KD4020R / 1350	815	320000	49 x 24 x 48
HDS 4.0/22 Ea ST NG	1.109-716.0	4	2200	Belt	6.2	230V / 1ph	29	KM4035R / 1250	843	364000	49 x 24 x 48
HDS 4.0/22 Eb ST NG	1.109-717.0	4	2200	Belt	6.2	230V / 3ph	16	KM4035R / 1250	843	364000	49 x 24 x 48
HDS 4.0/22 Ec ST NG	1.109-718.0	4	2200	Belt	6.2	460V / 3ph	7	KM4035R / 1250	843	364000	49 x 24 x 48
HDS 4.0/22 Ef ST NG	1.109-719.0	4	2200	Belt	6.2	575V / 3ph	6.5	KM4035R / 1250	843	364000	49 x 24 x 48
HDS 4.0/22 Eg ST NG	1.109-720.0	4	2200	Belt	6.2	208V / 1ph	30	KM4035R / 1250	843	364000	49 x 24 x 48
HDS 4.0/22 Eh ST NG	1.109-721.0	4	2200	Belt	6.2	208V / 3ph	18	KM4035R / 1250	843	364000	49 x 24 x 48
HDS 3.9/30 Ea ST NG	1.109-723.0	3.9	3000	Belt	8.2	230V / 1ph	36	KM4035R / 1225	856	354000	49 x 24 x 48
HDS 3.9/30 Eb ST NG	1.109-724.0	3.9	3000	Belt	8.2	230V / 3ph	25	KM4035R / 1225	856	354000	49 x 24 x 48
HDS 3.9/30 Ec ST NG	1.109-725.0	3.9	3000	Belt	8.2	460V / 3ph	11	KM4035R / 1225	856	354000	49 x 24 x 48
HDS 3.9/30 Ef ST NG	1.109-726.0	3.9	3000	Belt	8.2	575V / 3ph	14	KM4035R / 1225	856	354000	49 x 24 x 48
HDS 3.9/30 Eg ST NG	1.109-727.0	3.9	3000	Belt	8.2	208V / 1ph	38	KM4035R / 1225	856	354000	49 x 24 x 48
HDS 3.9/30 Eh ST NG	1.109-728.0	3.9	3000	Belt	8.2	208V / 3ph	27	KM4035R / 1225	856	354000	49 x 24 x 48
HDS 5.0/23 Ea ST NG	1.109-730.0	5.0	2300	Belt	8.2	230V / 1ph	36	KT6035R / 1225	856	439000	49 x 24 x 48
HDS 5.0/23 Eb ST NG	1.109-731.0	5.0	2300	Belt	8.2	230V / 3ph	25	KT6035R / 1225	856	439000	49 x 24 x 48
HDS 5.0/23 Ec ST NG	1.109-732.0	5.0	2300	Belt	8.2	460V / 3ph	11	KT6035R / 1225	856	439000	49 x 24 x 48
HDS 5.0/23 Ef ST NG	1.109-733.0	5.0	2300	Belt	8.2	575V / 3ph	14	KT6035R / 1225	856	439000	49 x 24 x 48
HDS 5.0/23 Eg ST NG	1.109-734.0	5.0	2300	Belt	8.2	208V / 1ph	38	KT6035R / 1225	856	439000	49 x 24 x 48
HDS 5.0/23 Eh ST NG	1.109-735.0	5.0	2300	Belt	8.2	208V / 3ph	27	KT6035R / 1225	856	439000	49 x 24 x 48
HDS 4.8/30 Ea ST NG	1.109-736.0	4.8	3000	Belt	10	230V / 1ph	42	KT6035R / 1225	885	415000	49 x 24 x 48
HDS 4.8/30 Eb ST NG	1.109-737.0	4.8	3000	Belt	10	230V / 3ph	26	KT6035R / 1225	885	415000	49 x 24 x 48
HDS 4.8/30 Ec ST NG	1.109-738.0	4.8	3000	Belt	10	460V / 3ph	15	KT6035R / 1225	885	415000	49 x 24 x 48
HDS 4.8/30 Ef ST NG	1.109-739.0	4.8	3000	Belt	10	575V / 3ph	14	KT6035R / 1225	885	415000	49 x 24 x 48
HDS 4.8/30 Eg ST NG	1.109-740.0	4.8	3000	Belt	10	208V / 1ph	49	KT6035R / 1225	885	415000	49 x 24 x 48
HDS 4.8/30 Eh ST NG	1.109-741.0	4.8	3000	Belt	10	208V / 3ph	32	KT6035R / 1225	885	415000	49 x 24 x 48

## TECHNICAL DATA

Model	Part No.	GPM	PSI	Drive	HP	Electrical	Amps	Pump	Ship Weight (lbs)	BTU	Ship Dimensions (L x W x H) Inches
<b>Natural Gas-Heated 6.3+ GPM Large Cabinet Design</b>											
HDS 6.3/32 Eb ST NG	1.109-744.0	6.3	3200	Belt	15	230V / 3ph	39	KT6035R / 1625	1825	507000	64 x 35 x 61
HDS 6.3/32 Ec ST NG	1.109-745.0	6.3	3200	Belt	15	460V / 3ph	19	KT6035R / 1625	1825	507000	64 x 35 x 61
HDS 6.3/32 Ef ST NG	1.109-746.0	6.3	3200	Belt	15	575V / 3ph	18	KT6035R / 1625	1825	507000	64 x 35 x 61
HDS 6.3/32 Eh ST NG	1.109-747.0	6.3	3200	Belt	15	208V / 3ph	39	KT6035R / 1625	1825	507000	64 x 35 x 61
HDS 8.0/32 Eb ST NG	1.109-748.0	8.0	3200	Belt	20	230V / 3ph	46	KX9536R / 1458	1840	658000	64 x 35 x 61
HDS 8.0/32 Ec ST NG	1.109-749.0	8.0	3200	Belt	20	460V / 3ph	26	KX9536R / 1458	1840	658000	64 x 35 x 61
HDS 8.0/32 Ef ST NG	1.109-750.0	8.0	3200	Belt	20	575V / 3ph	21	KX9536R / 1458	1840	658000	64 x 35 x 61
HDS 8.0/32 Eh ST NG	1.109-751.0	8.0	3200	Belt	20	208V / 3ph	60	KX9536R / 1458	1840	658000	64 x 35 x 61
HDS 9.5/30 Eb ST NG	1.109-752.0	9.5	3000	Belt	20	230V / 3ph	52	KX1036R / 1650	1910	816000	64 x 35 x 61
HDS 9.5/30 Ec ST NG	1.109-753.0	9.5	3000	Belt	20	460V / 3ph	26	KX1036R / 1650	1910	816000	64 x 35 x 61
HDS 9.5/30 Ef ST NG	1.109-754.0	9.5	3000	Belt	20	575V / 3ph	21	KX1036R / 1650	1910	816000	64 x 35 x 61
HDS 9.5/30 Eh ST NG	1.109-755.0	9.5	3000	Belt	20	208V / 3ph	60	KX1036R / 1650	1910	816000	64 x 35 x 61

# SECHURA - LP

## TECHNICAL DATA

Model	Part No.	GPM	PSI	Drive	HP	Electrical	Amps	Pump	Ship Weight (lbs)	BTU	Ship Dimensions (L x W x H) Inches
<b>LP Gas-Heated 3.5-5.0 GPM Medium Cabinet Design</b>											
HDS 3.5/20 Ea ST LP	1.109-756.0	3.5	2000	Belt	5	230V / 1ph	25	KD4020R / 1350h	815	320000	49 x 24 x 48
HDS 4.0/22 Ea ST LP	1.109-757.0	4	2200	Belt	6.2	230V / 1ph	29	KM4035R / 1250	843	364000	49 x 24 x 48
HDS 4.0/22 Eb ST LP	1.109-758.0	4	2200	Belt	6.2	230V / 3ph	16	KM4035R / 1250	843	364000	49 x 24 x 48
HDS 4.0/22 Ec ST LP	1.109-759.0	4	2200	Belt	6.2	460V / 3ph	7	KM4035R / 1250	843	364000	49 x 24 x 48
HDS 4.0/22 Ef ST LP	1.109-760.0	4	2200	Belt	6.2	575V / 3ph	6.5	KM4035R / 1250	843	364000	49 x 24 x 48
HDS 4.0/22 Eg ST LP	1.109-761.0	4	2200	Belt	6.2	208V / 1ph	30	KM4035R / 1250	843	364000	49 x 24 x 48
HDS 4.0/22 Eh ST LP	1.109-762.0	4	2200	Belt	6.2	208V / 3ph	18	KM4035R / 1250	843	364000	49 x 24 x 48
HDS 3.9/30 Ea ST LP	1.109-764.0	3.9	3000	Belt	8.2	230V / 1ph	36	KM4035R / 1225	856	354000	49 x 24 x 48
HDS 3.9/30 Eb ST LP	1.109-765.0	3.9	3000	Belt	8.2	230V / 3ph	25	KM4035R / 1225	856	354000	49 x 24 x 48
HDS 3.9/30 Ec ST LP	1.109-766.0	3.9	3000	Belt	8.2	460V / 3ph	11	KM4035R / 1225	856	354000	49 x 24 x 48
HDS 3.9/30 Ef ST LP	1.109-767.0	3.9	3000	Belt	8.2	575V / 3ph	14	KM4035R / 1225	856	354000	49 x 24 x 48
HDS 3.9/30 Eg ST LP	1.109-768.0	3.9	3000	Belt	8.2	208V / 1ph	38	KM4035R / 1225	856	354000	49 x 24 x 48
HDS 3.9/30 Eh ST LP	1.109-769.0	3.9	3000	Belt	8.2	208V / 3ph	27	KM4035R / 1225	856	354000	49 x 24 x 48
HDS 5.0/23 Ea ST LP	1.109-771.0	5.0	2300	Belt	8.2	230V / 1ph	36	KT6035R / 1225	856	439000	49 x 24 x 48
HDS 5.0/23 Eb ST LP	1.109-772.0	5.0	2300	Belt	8.2	230V / 3ph	25	KT6035R / 1225	856	439000	49 x 24 x 48
HDS 5.0/23 Ec ST LP	1.109-773.0	5.0	2300	Belt	8.2	460V / 3ph	11	KT6035R / 1225	856	439000	49 x 24 x 48
HDS 5.0/23 Ef ST LP	1.109-774.0	5.0	2300	Belt	8.2	575V / 3ph	14	KT6035R / 1225	856	439000	49 x 24 x 48
HDS 5.0/23 Eg ST LP	1.109-775.0	5.0	2300	Belt	8.2	208V / 1ph	38	KT6035R / 1225	856	439000	49 x 24 x 48
HDS 5.0/23 Eh ST LP	1.109-776.0	5.0	2300	Belt	8.2	208V / 3ph	27	KT6035R / 1225	856	439000	49 x 24 x 48
HDS 4.8/30 Ea ST LP	1.109-777.0	4.8	3000	Belt	10	230V / 1ph	42	KT6035R / 1225	885	415000	49 x 24 x 48
HDS 4.8/30 Eb ST LP	1.109-778.0	4.8	3000	Belt	10	230V / 3ph	26	KT6035R / 1225	885	415000	49 x 24 x 48
HDS 4.8/30 Ec ST LP	1.109-779.0	4.8	3000	Belt	10	460V / 3ph	15	KT6035R / 1225	885	415000	49 x 24 x 48
HDS 4.8/30 Ef ST LP	1.109-780.0	4.8	3000	Belt	10	575V / 3ph	14	KT6035R / 1225	885	415000	49 x 24 x 48
HDS 4.8/30 Eg ST LP	1.109-781.0	4.8	3000	Belt	10	208V / 1ph	49	KT6035R / 1225	885	415000	49 x 24 x 48
HDS 4.8/30 Eh ST LP	1.109-782.0	4.8	3000	Belt	10	208V / 3ph	32	KT6035R / 1225	885	415000	49 x 24 x 48

## TECHNICAL DATA

Model	Part No.	GPM	PSI	Drive	HP	Electrical	Amps	Pump	Ship Weight (lbs)	BTU	Ship Dimensions (L x W x H) Inches
<b>Natural Gas-Heated 6.3+ GPM Large Cabinet Design</b>											
HDS 6.3/32 Eb ST LP	1.109-785.0	6.3	3200	Belt	15	230V / 3ph	39	KT6035R / 1625	1825	507000	64 x 35 x 61
HDS 6.3/32 Ec ST LP	1.109-786.0	6.3	3200	Belt	15	460V / 3ph	19	KT6035R / 1625	1825	507000	64 x 35 x 61
HDS 6.3/32 Ef ST LP	1.109-787.0	6.3	3200	Belt	15	575V / 3ph	18	KT6035R / 1625	1825	507000	64 x 35 x 61
HDS 6.3/32 Eh ST LP	1.109-788.0	6.3	3200	Belt	15	208V / 3ph	39	KT6035R / 1625	1825	507000	64 x 35 x 61
HDS 8.0/32 Eb ST LP	1.109-789.0	8.0	3200	Belt	20	230V / 3ph	46	KX9536R / 1458	1840	658000	64 x 35 x 61
HDS 8.0/32 Ec ST LP	1.109-790.0	8.0	3200	Belt	20	460V / 3ph	26	KX9536R / 1458	1840	658000	64 x 35 x 61
HDS 8.0/32 Ef ST LP	1.109-791.0	8.0	3200	Belt	20	575V / 3ph	21	KX9536R / 1458	1840	658000	64 x 35 x 61
HDS 8.0/32 Eh ST LP	1.109-792.0	8.0	3200	Belt	20	208V / 3ph	60	KX9536R / 1458	1840	658000	64 x 35 x 61
HDS 9.5/30 Eb ST LP	1.109-793.0	9.5	3000	Belt	20	230V / 3ph	52	KX1036R / 1650	1910	775000	64 x 35 x 61
HDS 9.5/30 Ec ST LP	1.109-794.0	9.5	3000	Belt	20	460V / 3ph	26	KX1036R / 1650	1910	775000	64 x 35 x 61
HDS 9.5/30 Ef ST LP	1.109-795.0	9.5	3000	Belt	20	575V / 3ph	21	KX1036R / 1650	1910	775000	64 x 35 x 61
HDS 9.5/30 Eh ST LP	1.109-796.0	9.5	3000	Belt	20	208V / 3ph	60	KX1036R / 1650	1910	775000	64 x 35 x 61

# HDS VHP



## For dirt and grime indoors and out.

Looking for a heavy-duty pressure washer that can handle the dirt and grime indoors and out? Then the versatile HDS VHP is the right machine for the task. Available in both 120V and 230V configurations, this hot water pressure washer features cleaning power up to 2.5 GPM and 2000 PSI. And, since the HDS VHP is built with tubed pneumatic tires, this heavy-duty series delivers power wherever the job takes you. It is designed for vapor type propane only.



### Features

- Belt-driven Kärcher pump with a 7-year warranty
- Four tubed pneumatic tires provide excellent maneuverability
- Extra-durable heating coil is made of leak-free, cold-rolled steel pipe and features a 5-year warranty
- Features a rugged 10 gauge steel chassis with polyester powder coat finish
- EASY!Force gun with cruise control like technology - uses its own recoil force to hold the trigger down - so, no more sore hands after hours of use

### TECHNICAL DATA

Model	Part No.	GPM	PSI	HP	Electrical	Amps	Pump RPM	Pump	BTU	Ship Weight (lbs)	Ship Dimensions (L x W x H) Inches
HDS VHP2-15024D	1.109-556.0	1.8	1500	2	120V / 1ph	17	1100	KP3030R	140,000	470	50" x 26" x 41"
HDS VHP3-20024A	1.109-557.0	2.5	2000	5	230V / 1ph	20	1375	KP3030R	245,000	500	50" x 26" x 41"

### ACCESSORIES

Order No.	Description
■ 8.756-481.0 ■	EASY!Force trigger gun (North American Model) - zero force required. Standard 1/4" connection for wand, 3/8" connection for hose.

### OPTIONS (FACTORY INSTALLED)

Order No.	Description
<input type="checkbox"/> 8.903-538.0	Stainless-steel motor cover
<input type="checkbox"/> 8.903-501.0	Electronic ignition (convenience in lighting pilot) for 120V machine
<input type="checkbox"/> 8.925-856.0	Electronic ignition (convenience in lighting pilot) for 230V machine

■ Included    Optional   ■ Please Note: NOT compatible with EASY!Lock

# HDS P / PE CAGE



## Outstanding on all terrains.

Built on a rugged 1-1/4" powder coated steel frame, these compact gas roll cage models are designed for construction sites, farms and factories. The different models deliver hot water cleaning of up to 3500 PSI. Each features a Kärcher pump with limited 7-year warranty, industrial-grade motor and flat-free tires.



## Features

- Flat-free tires
- 7-year pump warranty
- EASY!Force gun with cruise control like technology - uses its own recoil force to hold the trigger down - so, no more sore hands after hours of use

## TECHNICAL DATA

Model	Part No.	GPM	PSI	Drive	CC	Engine	Start	Pump	Burner	CARB*	Ship Weight (lbs)	Ship Dimensions (L x W x H) Inches
HDS 2.8/25 P Cage	1.575-555.0	2.7	2400	Direct	196	Honda GX200	Recoil	Kärcher KG	12V DC	No	406	50 x 40 x 50
HDS 2.6/30 P Cage	1.575-550.0	3.0	3000	Direct	270	Honda GX270	Recoil	Kärcher KP	12V DC	No	500	50 x 40 x 58
HDS 3.5/30 P Cage	1.575-551.0	3.5	3000	Direct	337	Honda GX340	Recoil	Kärcher KS	12V DC	No	550	50 x 40 x 58
HDS 3.5/30 Pe Cage	1.575-552.0	3.5	3000	Direct	337	Honda GX340	Electric	Kärcher KS	12V DC	No	560	50 x 40 x 58
HDS 3.5/35 Pe Cage	1.575-553.0	3.5	3500	Direct	389	Honda GX390	Electric	Kärcher KS	12V DC	No	595	50 x 40 x 58
HDS 3.5/35 Pe Cage	1.110-085.0	3.5	3500	Direct	389	Vanguard 400	Electric	Kärcher KS	12V DC	Yes	595	50 x 40 x 58

## ACCESSORIES

Order No.	Description
■ 8.756-481.0	EASY!Force trigger gun (North American Model) - zero force required. Standard 1/4" connection for wand, 3/8" connection for hose.
■ Included	□ Optional
■ Please Note: NOT compatible with EASY!Lock *CARB compliance required for sale in California	

## JALAPAO SERIES



### The industrial workhorse.

Kärcher Jalapao series oil-fired skids are the workhorses of the pressure washer industry. Delivering up to 8.0 GPM of hot water and up to 3500 PSI, these rugged gas and diesel-powered machines are built on an open frame using heavy-gauge 1-1/4" powder coated steel and are ideal for mounting in a truck or on a trailer. The electric-start engine and powerful belt-drive Kärcher KT and KX pumps are isolated from the rest of the machine on a shock-mounted sub-frame to reduce vibration. Steam combination comes standard with all models.



POWERED by  
**HONDA**



### Features

- Honda, Vanguard and Kubota engines with electric start
- Kärcher belt-drive tri-plunger pumps with 7-year warranty
- EASY!Force gun with cruise control like technology - uses its own recoil force to hold the trigger down - so, no more sore hands after hours of use

### TECHNICAL DATA

Model	Part No.	GPM	PSI	Drive	CC	Engine	Fuel	Pump	Burner	CARB*	Ship Weight (lbs)	Ship Dimensions (L x W x H) Inches
HDS 3.9/30 Pe Cage	1.575-600.0	3.9	3000	Belt	389	Honda GX390	Gas	Kärcher KT	12V DC	No	790	54 x 56 x 55
HDS 4.8/30 Pe Cage	1.575-601.0	4.8	3000	Belt	570	Vanguard 18	Gas	Kärcher KT	12V DC	Yes	800	54 x 56 x 55
HDS 4.8/30 Pe Cage	1.575-602.0	4.8	3000	Belt	570	Vanguard 18	Gas	Kärcher KT	120V AC	Yes	945	54 x 56 x 55
HDS 4.7/35 Pe Cage	1.575-603.0	4.7	3500	Belt	688	Honda GX630	Gas	Kärcher KT	12V DC	Yes	855	54 x 56 x 55
HDS 4.7/35 Pe Cage	1.575-604.0	4.7	3500	Belt	688	Honda GX630	Gas	Kärcher KT	120V AC	Yes	890	54 x 56 x 55
HDS 5.6/35 Pe Cage	1.575-605.0	5.6	3500	Belt	688	Honda GX690	Gas	Kärcher KT	12V DC	Yes	852	54 x 56 x 55
HDS 5.6/35 Pe Cage	1.575-606.0	5.6	3500	Belt	688	Honda GX690	Gas	Kärcher KT	120V AC	Yes	970	54 x 56 x 55
HDS 5.6/35 De Cage	1.110-622.0	5.4	3500	Belt	1123	Kubota D1105-E3B	Diesel	Kärcher KT	12V DC	Yes	1214	54 x 56 x 55
HDS 5.6/35 De Cage	1.110-623.0	5.4	3500	Belt	1123	Kubota D1105-E3B	Diesel	Kärcher KT	120V AC	Yes	1300	54 x 56 x 55
HDS 8.0/30 Ge Cage	1.575-611.0	8.0	3000	Belt	688	Honda GX690	Gas	Kärcher KX	12V DC	Yes	805	54 x 56 x 55
HDS 8.0/30 Ge Cage	1.575-612.0	8.0	3000	Belt	688	Honda GX690	Gas	Kärcher KX	120V AC	Yes	865	54 x 56 x 55

### ACCESSORIES

Order No.	Description
■ 8.756-481.0 ■	EASY!Force trigger gun (North American Model) - zero force required. Standard 1/4" connection for wand, 3/8" connection for hose.

### OPTIONS

Order No.	Description
<input type="checkbox"/> 8.904-051.0	Battery (NOT for use with GX390 models or Kubota, field installed)
<input type="checkbox"/> 8.903-430.0	Stackless flue adapter (field installed)
■ Included <input type="checkbox"/> Optional ■ Please Note: NOT compatible with EASY!Lock *CARB compliance required for sale in California	





## TULE SERIES HDS 3.5/40 GE MT



Shown with optional hose reel

### Towable and maneuverable hot water pressure washer.

Ready to pick up and go at a moments notice, Kärcher's Tule Series HDS 3.5/40 Ge MT hot water pressure washer trailer provides the necessary cleaning power on virtually any job site which has a water source. Simply unhitch the Tule Series HDS 3.5/40 Ge MT and take the cleaning power where you need it most. The Tule Series trailer features a reliable Honda engine, 8 gallon diesel fuel tank, electric start with manual start backup and much more.

U.S. Design Patent No. 9,724,734 B2



POWERED by  
**HONDA**



### Features

- Honda GX 390 engine and electric start with manual start backup
- Adjustable thermostat for water temperature regulation
- 8 gallon diesel fuel tank
- Lift handle and swing away tongue for easier hook up of the trailer and storage
- EASY!Force gun with cruise control like technology - uses its own recoil force to hold the trigger down - so, no more sore hands after hours of use

### TECHNICAL DATA

Model	Part No.	GPM	PSI	Drive	Engine	Start	Pump	CARB*	Ship Weight (lbs)	Ship Dimensions (L x W x H) Inches
HDS 3.5/40 Ge MT	1.103-844.0	3.5	4000	Direct	Honda GX390	Electric	Kärcher KS	No	750	100 x 45 x 75

### ACCESSORIES

Order No.	Description
■ 8.756-481.0 ■	EASY!Force trigger gun (North American Model) - zero force required. Standard 1/4" connection for wand, 3/8" connection for hose.
■ 8.756-797.0	3-5 GPM Chemical Injector Kit
■ 8.754-990.0	12V Battery (required for hot water operation)
■ 8.711-293.0	Zinc plated variable pressure lance
■ 8.925-182.0	50', 3/8" hose, double-wire at 6000 PSI

### OPTIONS (FACTORY INSTALLED)

Order No.	Description
<input type="checkbox"/> 8.924-367.0	2-5/16" Ball Coupler
<input type="checkbox"/> 8.924-667.0	Lifting Kit
<input type="checkbox"/> 8.924-370.0	LED Lights
<input type="checkbox"/> 8.924-700.0	2-inch Collar Lock Coupler
<input type="checkbox"/> 8.924-368.0	3" Lunette coupler

### OPTIONS (FIELD INSTALLED)

Order No.	Description
<input type="checkbox"/> 8.750-682.0	Hose Reel Fixed 100', 5000 PSI, 325° F, equipped for 3/8" hose
<input type="checkbox"/> 8.925-255.0	Hose Reel Bracket (Mount Kit)

■ Included  Optional ■ Please Note: NOT compatible with EASY!Lock \*CARB compliance required for sale in California

# TRK-3500



Shown with optional hot water pressure washer skid, rock guard, and hose reel.

## High cleaning performance.

Adaptable and designed to accommodate a variety of pressure washer skids, the Kärcher TRK-3500 pressure washer trailer is affordable, versatile, and easy to ship and store. Made of rugged 14-gauge steel, the trailer's wheel and axle assembly feature a leaf-spring suspension of up to 3,500 lbs. Get cleaning by simply picking a compatible pressure washer and adding must-have options and accessories.



## Features

- High-density, polyethylene 200-gallon water tank with a 12-inch access port, 3/4-inch float valve and a 50-mesh inlet filter; and two 5/16-inch chains for additional safety
- Electric brakes and break away kit
- Electrical wiring recessed within the heavy-duty frame
- Saddle boxes, lighted license plate holder and recessed tail lights
- 1,000 lb. swivel jack with a 2-inch ball coupler for quick and easy hook up of the trailer
- Optional hose reels hold up to 100 ft. of high-pressure hose and quick connects to chassis

## TECHNICAL DATA

Model	Part No.	Axle	(GVWR) lbs.	Water Tank (Gallons)	Ship Weight (lbs)*	Ship Dimensions (L x W x H) inches
TRK-3500	1.103-849.0	Single	3500	200	1072	138 x 66 x 52

\*Trailer and water tank only

## PRECONFIGURED TRAILERS

Order No.	Part No.
1.103-850.0	Trailer Kärcher 3500E HDS 4.7/35 (electric brakes)
1.103-851.0	Trailer Kärcher 3500H HDS 4.7/35 (hydraulic brakes)

Preconfigured trailer packages include the TRK-3500 trailer, HDS 4.7/35 Pe Cage pressure washer, mounting kit, battery and high and low-pressure hose reels.

## OPTIONS (FACTORY INSTALLED)

Order No.	Description
<input type="checkbox"/> 8.917-294.0	North American engineered series skid mounting kit (required for mounting pressure washer to trailer)
<input type="checkbox"/> 8.931-496.0	Hydraulic brakes
<input type="checkbox"/> 8.917-554.0	High pressure hose reel kit (100' capacity) ♦
<input type="checkbox"/> 8.917-555.0	Low pressure hose reel kit (100' capacity) ♦
<input type="checkbox"/> 8.924-493.0	2-5/16" Ball hitch coupler
<input type="checkbox"/> 8.924-368.0	3" Lunette eye coupler
<input type="checkbox"/> 8.931-506.0	Rock guard with wand holder
<input type="checkbox"/> 8.904-051.0	Battery installed on pressure washer

■ Included  Optional ♦Hose not included

# TRK-6000



TRK-6000 - shown with options and gas-powered hot water pressure washer; accommodates both gas and diesel-powered pressure washers. Tool box shown is no longer available on this unit.

## Customizable mobile solution.

Kärcher has made customizing a mobile wash system for on-site cleaning easy.

1. Choose a compatible skid-mounted hot water pressure washer for the dual-axle TRK-6000 trailer. The trailer comes with a 330-gallon water tank.
2. Customize your trailer with a broad selection of options and accessories, such as hose reels, chrome coverings, etc.



## Features

- Electrical wiring recessed within tubular frame
- Lighted license plate holder and recessed tail lights
- 1,000 lb. swivel jack with a 2-5/16 inch ball coupler for quick and easy hook up of the trailer
- Two 3-way ball valve for easy switching of the water flow from the holding tank to a faucet
- High-density, polyethylene 200-330 gallon water tank with a 12-inch access port, 1 1/2-inch drain valve, 3/4-inch float valve and a 50-mesh inlet filter; and two 5/16-inch chains for added safety
- Electric brakes and break away kit
- Rugged steel cage for security while transporting

## TECHNICAL DATA

Model	Part No.	Axle	(GVWR) lbs.	Water Tank (Gallons)	Ship Weight (lbs)*	Ship Dimensions (L x W x H) Inches
TRK-6000	1.103-807.0	Tandem	6000	330	1080	185 x 82 x 65

\*Trailer and water tank only

## OPTIONS (FACTORY INSTALLED)

Order No.	Description
<input type="checkbox"/> 8.904-051.0	Battery installed on pressure washer
<input type="checkbox"/> 8.902-438.0	Hydraulic brakes, two axles, 2-5/16" ball coupler
<input type="checkbox"/> 8.902-452.0	Hydraulic brakes, two axles, 3" Lunette eye coupler
<input type="checkbox"/> 8.902-471.0	3" Lunette eye hitch coupler
<input type="checkbox"/> 8.912-409.0	2-5 gallon bucket chemical rack (factory installed only)
<input type="checkbox"/> 8.902-447.0	Hose reel kit for 100 ft. Of 3/8-inch high-pressure hose (no hose included)
<input type="checkbox"/> 8.902-448.0	Hose reel kit for 200 ft. Of 3/8-inch high-pressure hose (no hose included)
<input type="checkbox"/> 8.902-449.0	Hose reel kit for 75 ft. Of 3/4-inch industrial garden hose (no hose included)
<input type="checkbox"/> 8.902-455.0	Skid mounting & plumbing kit (required for mounting pressure washer to trailer)
<input type="checkbox"/> 8.902-469.0	Sign plate
<input type="checkbox"/> 8.902-466.0	Chrome wheels, pair, (2 pair required)
<input type="checkbox"/> 8.902-468.0	Chrome fenders, pair
<input type="checkbox"/> 8.924-475.0	2" ball coupler

■ Included □ Optional ■ Please Note: NOT compatible with EASY!Lock

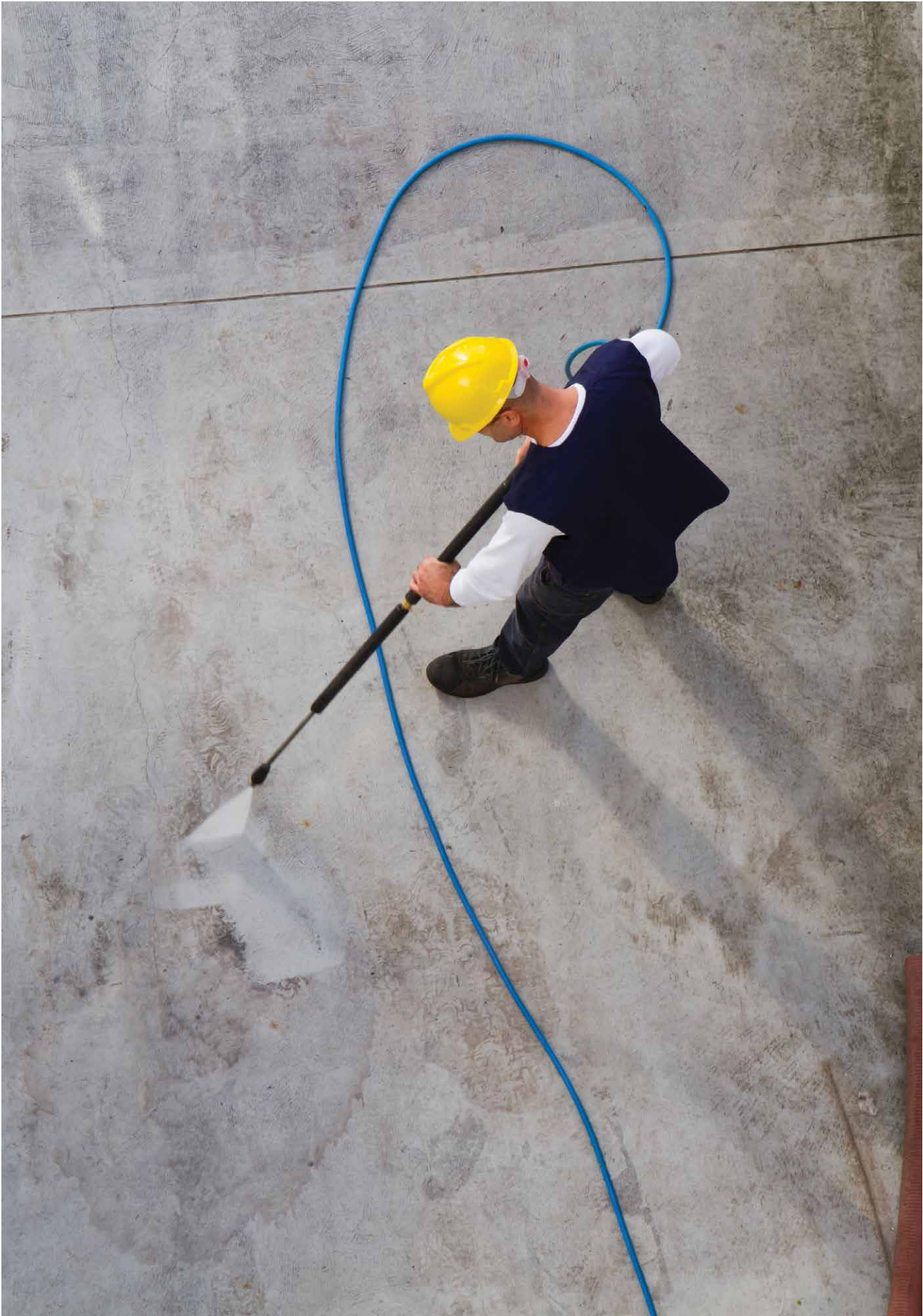

# PRO HD 400 ED



## Practical anywhere.

The PRO HD 400 ED is a light weight, durable and compact cold water pressure washer that offers ultimate mobility for on-site applications and is designed to be stored, transported and operated in the vertical and horizontal position. It's features include a reliable 3-piston axial-pump with a brass cylinder head, an automatic pressure relief system for protecting the pump and storage options for accessories.



## Features

- Vertical and horizontal operation for maximum flexibility and stability
- Rubber strap for secure storage of high-pressure hose
- EASY!Force gun with cruise control like technology - uses its own recoil force to hold the trigger down - so, no more sore hands after hours of use

## TECHNICAL DATA

Model	Part No.	GPM	PSI	Drive	Electrical	Amps	Pump	Ship Weight (lbs)	Ship Dimensions (L x W x H) Inches
Pro HD 400 ED	1.520-990.0	1.7	1300	Direct	120V / 1ph ~ / 60 Hz	14	Kärcher Axial	45	36 x 14 x 13

## ACCESSORIES

Order No.	Description
■ 4.118-005.0 ■	EASY!Force trigger gun
■ 4.112-006.0 ■	33" Spray lance
■ 6.110-034.0 ■	33' EASY!Lock hose
■ 2.113-062.0 ■	Power nozzle, 030
□ 4.113-003.0 ■	Rotating washing brush natural fiber bristles
□ 4.111-022.0 ■	Nozzle connector
□ 4.111-037.0 ■	Coupling
□ 2.115-000.0 ■	Quick-release coupling
□ 2.115-001.0 ■	Nipple
□ 4.114-018.0 ■	Performance Dirtblaster
□ 4.112-000.0 ■	41" Spray lance
□ 2.111-016.0 ■	Surface cleaner FR TR Classic
□ 2.111-017.0 ■	Surface cleaner FR Classic DIY
□ 4.111-032.0 ■	Adapter M 22 Swivel
□ 4.112-011.0 ■	Screw connector part
□ 6.110-034.0 ■	Extension hose 33'

■ Included □ Optional ■ Compatible with EASY!Lock

# HD COMPACT CLASS



## Designed to move.

The HD 1.8/13 C compact cold water pressure washer offers maximum portability, maneuverability and smart features. It can be stored, transported and operated in the vertical and horizontal position, and at 55.6 lbs, this professionally built unit can easily be moved by one person in and out of vehicles and around a cleaning site. It also includes storage options for accessories.



## Features

- Vertical and horizontal operation for maximum flexibility and stability
- Additional carrying handle for easy loading, unloading and moving
- Removable and easy to clean water inlet filter that protects the pump from debris
- Rubber strap for secure storage of high-pressure hose.
- EASY!Force gun with cruise control like technology - uses its own recoil force to hold the trigger down - so, no more sore hands after hours of use

## TECHNICAL DATA

Model	Part No.	GPM	PSI	Drive	Electrical	Amps	Pump	Ship Weight (lbs)	Ship Dimensions (L x W x H) Inches
HD 1.8/13 C	1.520-916.0	1.8	1300	Direct	120V / 1ph ~ / 60 Hz	14	Kärcher Axial	55.6	37 x 15 x 14

## ACCESSORIES

Order No.	Description
■ 4.118-005.0	EASY!Force trigger gun
■ 4.112-006.0	33" Spray lance
■ 6.110-034.0	33' EASY!Lock hose
■ 4.117-027.0	Triple jet nozzle, 032
□ 2.112-000.0	Inno Foam kit
□ 2.112-010.0	Easy Foam set
□ 4.112-035.0	Flexible spray lance
□ 6.110-049.0	Pipe cleaning hose 65', 1740 psi
□ 6.110-050.0	Pipe cleaning hose 98', 1740 psi
□ 6.110-008.0	Pipe cleaning hose 65', 3625 psi
□ 4.113.004.0	Rotating washing brush nylon bristles
□ 4.113-003.0	Rotating washing brush natural fiber bristles
□ 2.111-011.0	Surface cleaner FR 30
□ 2.111-016.0	Surface cleaner FR TR Classic
□ 2.111-010.0	Surface cleaner FRV TR 30
□ 4.115-006.0	Wet blasting attachment
□ 4.111-022.0	Nozzle connector
□ 4.111-037.0	Coupling
□ 2.115-000.0	Quick-release coupling
□ 2.115-001.0	Nipple

■ Included □ Optional ■ Compatible with EASY!Lock

## HD MID CLASS CAGE



### For commercial use under tough conditions.

Whether in vertical or horizontal use: the unheated Cage mid class can cope with any situation in tough, daily commercial use. These mobile, very robust machines are equipped with a 3-piston axial pump with brass cylinder head, which makes possible an improvement of up to 15 percent in cleaning performance and energy efficiency.



### Features

- Automatic pressure relief for protecting the components to extend their life
- Easy-to-access pump and electric box
- Sturdy, tubular steel frame protects all components and can be used to fasten the machine to a service vehicle

### TECHNICAL DATA

Model	Part No.	GPM	PSI	Drive	Electrical	Amps	Pump	Ship Weight (lbs)	Ship Dimensions (L x W x H) Inches
HD 2.3/15 M Cage Ed	1.150-936.0	2.3	1500	Direct	110V / 1ph	19	Kärcher Axial	86	18 X 16 X 39
HD 3.0/20 M Cage Ea	1.150-939.0	3	2000	Direct	230V / 1ph	18	Kärcher Axial	86	18 X 16 X 39

### ACCESSORIES

Order No.	Description
■ 4.118-005.0	EASY!Force trigger gun
■ 4.112-006.0	Jet pipe TR 33"
■ 2.113-043.0	Power nozzle TR 25036 (standard on 1.150-936.0)
■ 2.113-007.0	Power nozzle TR 25042 (standard on 1.150-939.0)
■ 6.110-034.0	High-pressure hose, 2 x EASY!Lock, DN 6, 3600 PSI, 33'
□ 6.110-035.0	High-pressure hose 2 x EASY!Lock DN 6, ANTI!Twist, 3600 PSI, 33'
□ 6.110-014.0	High-pressure hose, 2 x EASY!Lock, DN 8, ANTI!Twist, 4500 PSI, 100'
□ 6.110-030.0	High-pressure hose 2 x EASY!Lock DN 8, ANTI!Twist, 4500 PSI, 50'
□ 6.110-027.0	Longlife 400 high-pressure hose, 2 x EASY!Lock, DN 8, ANTI!Twist, 5800 PSI, 66'
□ 6.110-023.0	Longlife 400 high-pressure hose, 2 x EASY!Lock, DN 8, ANTI!Twist, 5800 PSI, 100'
□ 6.110-029.0	Longlife 400 high-pressure hose, 2 x EASY!Lock, DN 8, ANTI!Twist, 5800 PSI, 50'
□ 2.115-001.0	Male coupling
□ 2.115-000.0	Quick coupling
□ 4.114-041.0	Dirt blaster, large, size: 040
□ 2.111-013.0	Hard Surface Cleaner FR 30 Me
□ 2.111-010.0	FRV 30 Surface Cleaner
□ 2.640-401.0	Nozzle kit for FR 30 Me
□ 2.642-431.0	Nozzle kit for FRV 30

■ Included □ Optional ■ Compatible with EASY!Lock

# HD MID CLASS



## Loaded with features.

This medium class machine is extremely mobile and user-friendly with low-speed four-pole single phase motor for continuous use.



## Features

- Unique CHEM switch system allows operator to switch between two on-board detergent tanks without interruption; includes precise two-way metering valve to accurately vary detergent volume
- Robust, three-piston axial pump feature detergent-resistant brass cylinder head and stainless valves; pump is protected by pressure switch and overflow valve
- Features ground-fault circuit interrupter (GFCI) for operator safety

## TECHNICAL DATA

Model	Part No.	GPM	PSI	Drive	HP	Electrical	Amps	Pump	Ship Weight (lbs)	Ship Dimensions (L x W x H) Inches
HD 3.0/20-4M Ea	1.524-905.0	1.3-3.0	435-2000	Direct	4.7	220-240V / 1ph	20	Kärcher Axial	105	44 x 18 x 20

## ACCESSORIES

Order No.	Description
■ 4.118-005.0	■ EASY!Force trigger gun
■ 4.112-000.0	■ 33" spray lance
■ 6.110-035.0	■ 33' EASY!Lock hose
■ 2.113-009.0	■ Power nozzle TR 25047
■ 4.118-007.0	■ Rotary controller
□ 2.112-000.0	■ Inno Foam kit
□ 2.112-010.0	■ Easy foam set
□ 2.111-013.0	■ FR 30 ME surface cleaner
□ 2.111-023.0	■ FR TR 50 ME hard surface cleaner
□ 2.111-011.0	■ Surface cleaner FR 30
□ 2.111-010.0	■ FRV TR 30 hard surface cleaner
□ 4.115-000.0	■ Wet blasting attachment
□ 4.115-006.0	■ Wet blasting attachment
□ 2.111-009.0	■ Nozzle kit
□ 2.113-003.0	■ Power nozzle 40° spray angle

■ Included □ Optional ■ Compatible with EASY!Lock



# HD SUPER CLASS



## For tough jobs in non-stop use.

Where vast amounts of dirt accumulate every day, reliable Kärcher super class models provide indispensable services. Ideal for use in the construction, agricultural and forestry sectors as well as industrial and municipal facilities.

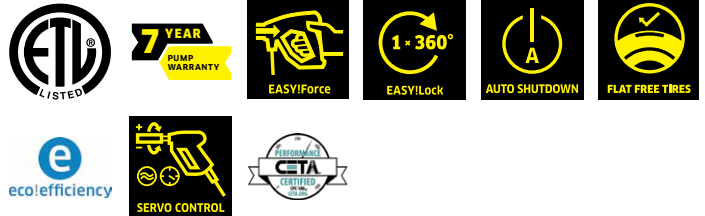

### Features

- Robust, three-piston axial pumps features detergent-resistant brass cylinder head and stainless valves; pumps is protected by pressure switch and over flow valve
- Low-speed, 4-pole, air-cooled motor runs quieter and cooler than conventional motors thus prolonging its service life
- EASY!Force gun with cruise control like technology – uses its own recoil force to hold the trigger down – so, no more sore hands after hours of use

### TECHNICAL DATA

Model	Part No.	GPM	PSI	Drive	HP	Electrical	Amps	Pump	Ship Weight (lbs)	Ship Dimensions (L x W x H) Inches
HD 3.5/30-4S Ea	1.286-908.0	1.8-3.5	435-3000	Direct	9	220/240V / 1ph	28	Kärcher Axial	178	47 x 21 x 23
HD 4.5/32-4S Eb	1.286-909.0	2.2-4.5	435-3200	Direct	10	230V / 3ph	25	Kärcher Axial	178	47 x 21 x 23
HD 4.5/32-4S Ec	1.286-910.0	2.2-4.5	435-3200	Direct	10	440V / 3ph	14	Kärcher Axial	160	47 x 21 x 23

### ACCESSORIES

Order No.	Description
■ 4.118-005.0 ■	EASY!Force trigger gun
■ 4.112-000.0 ■	41" spray lance
■ 6.110-030.0 ■	50' EASY!Lock hose with ANTI!Twist connection
■ 2.113-022.0 ■	Power nozzle, 045 (for machine 1.286-908.0)
■ 2.113-025.0 ■	Power nozzle, 055 (for machine 1.286-909.0)
□ 4.118-008.0 ■	Servo control
□ 2.112-000.0 ■	Inno Foam kit
□ 2.112-015.0 ■	Gutter cleaning lance
□ 4.112-035.0 ■	Flexible spray lance
□ 6.110-049.0 ■	Pipe cleaning hose 65', 1740 psi
□ 6.110-050.0 ■	Pipe cleaning hose 98', 1740 psi
□ 6.110-008.0 ■	Pipe cleaning hose 65', 3625 psi
□ 2.111-023.0 ■	FR TR 50 ME hard surface cleaner
□ 2.111-012.0 ■	FRV TR 30 ME
□ 2.111-011.0 ■	Surface cleaner FR 30
□ 2.111-010.0 ■	FRV TR 30 hard surface cleaner
□ 4.115-000.0 ■	Wet blasting attachment
□ 2.113-020.0 ■	25° power nozzle for applying cleaning agent
□ 4.114-019.0 ■	Dirtblaster Nozzle 035
□ 4.637-033.0 ■	Detergent injector for high pressure
□ 4.111-037.0 ■	Coupling

■ Included □ Optional ■ Compatible with EASY!Lock

# HD SPECIAL CLASS



## For strict hygiene requirements.

Cold water high-pressure cleaner was designed specifically for all-purpose industrial use in the sanitary/food industry. This top-of-the-range machine from the compact class allows you to regulate pressure and water flow seamlessly.



## Features

- Food-safe, non-marking high-pressure hose.
- Wear-resistant and non-marking gray wheels
- Accepts inlet water at temperatures up to 180oF
- Easy access to the variable pressure and water flow regulation and the "Inno Foam Set" high-pressure foam system can be used.
- EASY!Force gun with cruise control like technology - uses its own recoil force to hold the trigger down - so, no more sore hands after hours of use

## TECHNICAL DATA

Model	Part No.	GPM	PSI	Drive	HP	Electrical	Amps	Pump	Ship Weight (lbs)	Ship Dimensions (L x W x H) Inches
HD 2.3/14 C Ed Food	1.150-912.0	2.3	1400	Direct	3.2	120V / 1ph	20	Kärcher Axial	78	39 x 15 x 28

## ACCESSORIES

Order No.	Description
■ 4.118-015.0	EASY!Force trigger gun for food applications
■ 4.112-006.0	33" spray lance
■ 6.110-063.0	50' EASY!Lock food grade hose with AVS hose reel connection
■ 4.117-033.0	Triple jet nozzle, 040
□ 2.112-009.0	Inno Foam (food grade - including nozzle inserts)

■ Included □ Optional ■ Compatible with EASY!Lock

# HD WALL MOUNTED



## Convenient and quiet.

Kärcher's wall-mount unit has a durable steel frame, uses a quiet 1725 RPM motor, and is perfect for in-shop uses. A remote on/off switch with a 10' electrical cord allows the machine to be mounted high on a wall away from backspray.



Shown with optional wall mount bracket part no. 8.920-952.0

## Features

- Accepts hot water up to 180 degrees
- Remote on/off switch
- Kärcher Triplex crankcase pump

## TECHNICAL DATA

Model	Part No.	GPM	PSI	Drive	HP	Electrical	Amps	Pump	Ship Weight (lbs)	Ship Dimensions (L x W x H) Inches
HD 2.0/14 Ed +	1.107-088.0	1.8	1400	Direct	2	120V / 1ph	20	Kärcher KE	123	20 x 19 x 17

## ACCESSORIES

Order No.	Description
<input type="checkbox"/> 8.920-952.0	Wall mount bracket

■ Included  Optional

# HD SERIES ELECTRIC



## Designed for versatility.

Kärcher's cold water carts are corrosion-resistant aluminum pressure washers that easily convert from a cart to a skid for maximum cleaning versatility and durability. These reliable electric powered pressure washers have a low profile handle and compact footprint, making them easy to maneuver, and they offer a bypass loop for additional pump protection. 7-year pump warranty and flat-free tires.



## Features

- Durable, corrosion resistant aluminum frame
- Modular design - weld free frame easily converts from cart to skid
- Flat free tires
- VRT3 Unloader with bypass loop - pump protection
- Commercial-duty Leuco crankcase pump

## TECHNICAL DATA

Model	Part No.	GPM	PSI	Drive	HP	Electrical	Amps	Pump	Pump RPM	Ship Weight (lbs)	Ship Dimensions (L x W x H) Inches
HD 2.0/1000 Ed	9.801-814.0	2.0	1000	Direct	1.5	120V / 1ph	15	Kärcher KF	1725	161	41 x 22 x 25
HD 1.9/1300 Ed	9.801-794.0	1.9	1300	Direct	2	120V / 1ph	20	Kärcher KF	1725	175	41 x 22 x 25
HD 3.0/1000 Ed	9.801-795.0	3.0	1000	Direct	2	120V / 1ph	20	Kärcher KF	1725	180	41 x 22 x 25
HD 3.5/2000 Ea	9.801-796.0	3.5	2000	Direct	5	230V / 1ph	22	Kärcher KF	3450	181	41 x 22 x 25

## ACCESSORIES

Order No.	Description
■ 8.750-247.0	Gun
■ 8.925-129.0	Hose
■ 8.783-040.0	Lance
■ 9.802-216.0	Chemical injector
■ 8.712-398.0	Nozzle, QCEM-6540 Brass (Chem)
■ 8.712-337.0	Nozzle, red, 035
■ 8.712-338.0	Nozzle, yellow, 035
■ 8.712-339.0	Nozzle, green, 035
■ 8.712-340.0	Nozzle, white, 035
□ 8.712-429.0	Rotary nozzle
□ 8.925-229.0	Legacy, 100' x 3/8" ID, 4500 PSI, 2-wire, smooth cover, black high pressure hose
□ 8.753-572.0	A+ Surface Cleaner SC21
□ 8.753-573.0	A+ Surface Cleaner SC24
□ 9.302-243.0	Legacy Turbo Nozzle, 4.0, 4350 PSI
□ 8.710-620.0	Legacy Superlite stainless steel, 72" - 56.0 oz
□ 9.807-754.0	Skid mount feet
□ 9.807-750.0	37.5" long handle
□ 9.807-753.0	Lance holder
□ 9.807-752.0	Hose storage hook
□ 9.807-751.0	Handle with hose reel

■ Included □ Optional

## HD ROLL CAGE



### Specialty applications.

These belt-drive, electric roll cage models feature cleaning power of 5000 PSI and are available with either 230/3 phase or 460/3 phase motors. These units are specialty machines perfect for use in the marine market cleaning the bottom of boats or in the concrete industry, mixers, forms and handling equipment. Both models are ETL safety certified.



### Features

- Rugged steel chassis & roll cage
- Kärcher Belt-drive crankcase pump
- Cleaning power of 5000 PSI
- Flat-free tires
- 20 HP motor
- 50' high-pressure hose

### TECHNICAL DATA

Model	Part No.	GPM	PSI	Drive	HP	Electrical	Amps	Pump	Ship Weight (lbs)	Ship Dimensions (L x W x H) Inches
HD 5.0/50 Eb Cage	1.107-084.0	5.0	5000	Belt	20	230V / 3ph	48	Kärcher KX	524	42 x 26 x 30
HD 5.0/50 Ec Cage	1.107-087.0	5.0	5000	Belt	20	460V / 3ph	26	Kärcher KX	524	42 x 26 x 30

### ACCESSORIES

Order No.	Description
<input type="checkbox"/> 9.801-029.0	100' hose reel kit, 5000 PSI (hose not Included)

■ Included  Optional

# HD CABINET - BELT DRIVE



## Industrial throughout.

Our cold-water cabinet units really take the heat, accepting pre-heated water up to 145°F. Protected in durable stainless steel cabinets, they demonstrate industrial strength throughout, including belt-drive Kärcher crankcase pumps, industrial motors, and magnetic starters for operator safety.

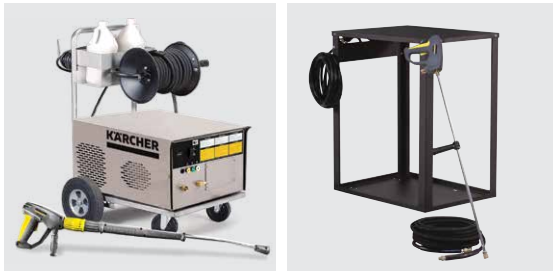

## Features

- Hour Meter is standard on all models
- A thermal pump protector to prevent the buildup of excessive pressures or heat
- High-Pressure Pump (with 7-year warranty) by dual, V-cogged belts.
- EASY!Force gun with cruise control like technology - uses its own recoil force to hold the trigger down - so, no more sore hands after hours of use

## TECHNICAL DATA

Model	Part No.	GPM	PSI	Drive	HP	Electrical	Amps	Pump	Ship Weight (lbs)	Ship Dimensions (L x W x H) Inches
HD 2.8/10 ST Ed B	1.106-603.0	2.8	1000	Belt	2	120V / 1ph	20	Kärcher KM	210	31 x 21 x 16
HD 3.9/20 ST Ea B	1.106-604.0	3.9	2000	Belt	6	230V / 1ph	29	Kärcher KM	285	31 x 21 x 16
HD 3.9/20 ST Ec B	1.106-605.0	3.9	2000	Belt	6	460V / 3ph	11	Kärcher KM	260	31 x 21 x 16
HD 3.9/20 ST Eh B	1.106-606.0	3.9	2000	Belt	6	208V / 3ph	16	Kärcher KM	265	31 x 21 x 16
HD 3.5/30 ST Ea B	1.106-607.0	3.5	3000	Belt	7.5	230V / 1ph	36	Kärcher KM	330	31 x 21 x 16
HD 3.5/30 ST Ec B	1.106-608.0	3.5	3000	Belt	7.5	460V / 3ph	11	Kärcher KM	270	31 x 21 x 16
HD 5.6/25 ST Ec B	1.106-609.0	5.6	2500	Belt	10	460V / 3ph	13.5	Kärcher KX	310	31 x 21 x 16

## ACCESSORIES

Order No.	Description
■ 8.756-481.0	EASY!Force trigger gun (North American Model) - zero force required. Standard 1/4" connection for wand, 3/8" connection for hose.
■ 9.801-013.0	Hour Meter (factory included)

## OPTIONS (FACTORY INSTALLED)

Order No.	Description
<input type="checkbox"/> 8.903-045.0	Kit Time Delay Shutdown (for HD 2.8/10 ST Ed B model)
<input type="checkbox"/> 8.929-374.0	Kit Time Delay Shutdown (for HD 4.2/20 ST Ea B model)
<input type="checkbox"/> 8.903-041.0	Kit Time Delay Shutdown (for HD 3.5/30 and HD 4.2/20 models, excluding HD 4.2/20 ST Ea B)
<input type="checkbox"/> 8.929-376.0	Kit Auto Start/Stop (for HD 2.8/10 ST Ed B model)
<input type="checkbox"/> 8.929-377.0	Kit Auto Start/Stop (for HD 4.2/20 ST Ea B model)
<input type="checkbox"/> 8.903-047.0	Kit Auto Start/Stop (for HD 3.5/30 and HD 4.2/20 models, excluding HD 4.2/20 ST Ea B)

## OPTIONS (FIELD INSTALLED)

Order No.	Description
<input type="checkbox"/> 9.801-033.0	Wall Mount Kit
<input type="checkbox"/> 8.903-043.0	Stainless Steel Wall Mount Kit
<input type="checkbox"/> 8.903-040.0	Floor Stand, 24" short
<input type="checkbox"/> 9.801-034.0	Floor Stand, 36" Tall
<input type="checkbox"/> 8.903-617.0	Stainless Steel Floor Stand, 36" Tall
<input type="checkbox"/> 8.941-546.0	Stainless Steel Floor Stand, without Hose Hanger
<input type="checkbox"/> 9.801-035.0	Wheel Kit for Floor Stands (4 casters)

## OPTIONS (FIELD INSTALLED)

Order No.	Description
<input type="checkbox"/> 9.801-031.0	Wheel Kit with Detergent Rack
<input type="checkbox"/> 8.904-527.0	Wheel Kit with Detergent Rack (stainless steel)
<input type="checkbox"/> 9.801-036.0	Hose Reel Kit, Floor Stand Only, 100 ft, No Hose
<input type="checkbox"/> 8.750-682.0	100' x 3/8" fixed base hose reel
<input type="checkbox"/> 8.919-437.0	Wall Mount
<input type="checkbox"/> 8.903-039.0	Kit, Hose Reel w/Bracket for Stand, Wall Mount Kits

■ Included □ Optional ■ Please Note: NOT compatible with EASY!Lock

# JARVIS SERIES



Jarvis 28" SCW 4.0/40 G (L) with Jarvis 21" SCW 2.4/25 G (Center) and SCW 2.4/25 CL (R)



## Quick and easy outdoor cleaning solution.

The Jarvis series is a complete solution for quick, streak-free cleaning of businesses' entrances, parking lots, tennis courts, pool decks and sidewalks. This easy to use cold water surface cleaner pressure washer is an all-in-one unit with the pump and engine attached to the surface cleaner.

Designed to attack the superficial dirt sweeping alone does not get. The Jarvis surface cleaner pressure washer is perfect for all operators - simple on / off operation and flat free tires. Choose between the Jarvis with a folding handle for easy transport and storage or a conveniently mounted hose reel with 50' of non-marking hose to have a more flexible and wider cleaning radius. Either way productivity is in your corner.



### Features

- 21" or 28" corrosion-resistant stainless steel surface cleaner housing and a professional grade swivel design
- Solid, powerful engines on each model with the Kärcher engine's 4-year warranty or the Honda GX engine's 3-year warranty
- Flat free tires
- Simple on / off operation
- EASY!Force gun with cruise control like technology - uses its own recoil force to hold the trigger down - so, no more sore hands after hours of use

### TECHNICAL DATA

Model	Part No.	Cleaning Width (Inches)	GPM	PSI	Drive	CC	Engine	Hose (Feet)	Pump	CARB*	Ship Weight (lbs)	Ship Dimensions (L x W x H) Inches
SCW 2.4/25 G - 21"	1.107-380.0	21	2.4	2500	Direct	200	Honda GX 200	10	KP3035G	Yes	159	44.0 x 27.6 x 34.2
SCW 2.4/25 CL - 21"	1.107-439.0	21	2.4	2500	Direct	212	Kärcher	10	KP3035G	Yes	159	44.0 x 27.6 x 34.2
SCW 4.0/40 G - 28"	1.107-437.0	28	4.0	4000	Direct	408	Kärcher	50	KS4040G.3	Yes	212	52.5 x 34.5 x 35.1

### ACCESSORIES

Order No.	Description
■ 8.756-481.0	EASY!Force trigger gun (North American Model) - zero force required. Standard 1/4" connection for wand, 3/8" connection for hose.
■ 8.711-370.0	Nozzle used on wand
■ 8.707-537.0	Nozzle used on spray arm of surface cleaner (2 needed)
■ 8.925-467.0	Hose, 1/4" x 10' R1
■ 8.708-582.0	Nozzle used on wand
■ 8.711-465.0	Nozzle used on spray arm of 28" Surface cleaner (2 needed)
■ 8.921-618.0	Hose, 3/8" x 50', SO x SW
□ 9.802-170.0	QC coupler for Gun
□ 8.929-857.0	Wand, 44"
□ 8.759-671.0	28" Deck for SC28
□ 8.759-672.0	Swivel Assembly SC28
□ 8.759-673.0	Kit Spray Arm SC28
□ 8.759-674.0	Kit 28" Brush Assembly SC28

■ Included □ Optional ■ Please Note: NOT compatible with EASY!Lock ■ Compatible with SCW 2.4/25 G & SCW 2.4/25 CL Only ■ Compatible with SCW 4.0/40 G Only \*CARB compliance required for sale in California

# TETON SERIES



## Cleaning versatility and durability.

Corrosion-resistant and light-weight, Kärcher's direct or belt drive, Teton Series aluminum pressure washers can be utilized as a cart or a skid for maximum cleaning versatility and durability. These reliable Kärcher powered pressure washers offer a 4-year engine warranty, bypass loop for additional pump protection, 7-year pump warranty and flat-free tires.



## Features

- Reliable Kärcher engine with an extended 4-year warranty
- Direct and belt drive models
- Durable VRT3 unloader with bypass loop diverts water flow when trigger gun is not activated
- Aluminum frame - modular design - converts easily from cart to skid
- CARB Compliant

## TECHNICAL DATA

Model	Part No.	GPM	PSI	Drive	CC	Engine	Pump	CARB*	Ship Weight (lbs)	Ship Dimensions (L x W x H) inches
HD 3.0/27 G Teton	1.107-398.0	3.0	2700	Direct	212	Kärcher	Crankcase	Yes	112	45 x 28 x 29
HD 4.0/40 G Teton	1.107-399.0	4.0	4000	Direct	420	Kärcher	Crankcase	Yes	130	45 x 28 x 29
HD 4.0/40 Ge Teton†	1.107-400.0	4.0	4000	Direct	420	Kärcher	Crankcase	Yes	158	45 x 28 x 29
HD 3.5/35 G Teton	1.107-440.0	3.5	3500	Direct	302	Kärcher	Crankcase	Yes	132	45 x 28 x 29
HD 3.0/27 GB Teton	1.107-441.0	3.0	2700	Belt	212	Kärcher	Crankcase	Yes	123	45 x 28 x 29
HD 3.5/35 GB Teton	1.107-442.0	3.5	3500	Belt	302	Kärcher	Crankcase	Yes	158	45 x 28 x 29
HD 4.0/40 GB Teton	1.107-443.0	4.0	4000	Belt	420	Kärcher	Crankcase	Yes	169	45 x 28 x 29
HD 4.0/40 GeB Teton	1.107-444.0	4.0	4000	Belt	420	Kärcher	Crankcase	Yes	205	45 x 28 x 29
HD 5.0/30 GB Teton	1.107-445.0	5.0	3000	Belt	420	Kärcher	Crankcase	Yes	169	45 x 28 x 29

## ACCESSORIES

Order No.	Description
■ 8.750-247.0	Trigger Gun, model M407
■ 8.925-129.0	Hose, 50' x 3/8", 1w, 4,000 PSI SWXSO
■ 8.783-039.0	Lance 30" Zinc plated, handle & coupler (for HD 3.0/27 G Classic)
■ 8.783-040.0	Lance 44" Zinc plated, handle & coupler (for HD 4.0/40 G Classic and HD 4.0/40 Ge Classic)
■ 9.802-216.0	Injector, Chem, NON ADJ, 0.083
□ 8.712-429.0	Nozzle
□ 8.925-229.0	Legacy, 100' x 3/8" ID, 6000 PSI, 2-wire, smooth cover, black high pressure hose
□ 8.753-572.0	A+ Surface Cleaner SC21
□ 8.753-573.0	A+ Surface Cleaner SC24
□ 9.302-243.0	Legacy Turbo Nozzle, 4.0, 4350 PSI
□ 8.710-620.0	Legacy Superlite stainless steel wand, 72" - 56.0 oz
□ 9.807-754.0	Skid mount feet
□ 9.807-750.0	37.5" long handle
□ 9.807-753.0	Lance holder
□ 9.807-752.0	Hose storage hook
□ 9.807-751.0	Handle with hose reel (mild steel anthracite handle)

■ Included □ Optional †Electric start available on select models. \*CARB compliance required for sale in California



# HD SERIES GAS



## Easily converts from cart to skid.

Corrosion-resistant and light-weight, Kärcher's HD Series Gas aluminum pressure washers have a durable weldless, modular frame that can be utilized as a cart or converted to a skid (optional - sold separately) for maximum cleaning versatility and durability. Easy to maneuver with puncture proof, flat free tires. These reliable Honda or Vanguard powered pressure washers offer a bypass loop for additional pump protection, 7-year pump warranty on the oil end of the pump. The simple design of the HD Gas helps get the job done quickly and without hassle.

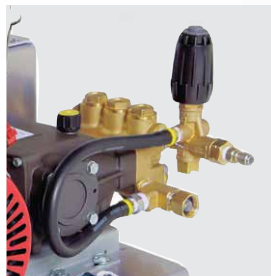

### Features

- Up to 4.0 GPM, 4000 PSI
- Belt or direct drive models with a reliable Honda or Vanguard engine
- Durable VRT3 unloader with bypass loop diverts water flow when trigger gun is not activated
- Compact Footprint with aluminum frame - modular design - converts easily from cart to skid

### TECHNICAL DATA

Model	Part No.	GPM	PSI	Drive	Start	Pump	CC	Engine	CARB*	Ship Weight (lbs)	Ship Dimensions (L x W x H) Inches
HD 3.0/27 G	9.807-719.0	3.0	2700	Direct	Recoil	Crankcase	196	Honda GX200	Yes	112	45 x 28 x 29
HD 3.5/35 G	9.807-720.0	3.5	3500	Direct	Recoil	Crankcase	270	Honda GX270	No	130	45 x 28 x 29
HD 3.5/35 G	1.107-421.0	3.5	3500	Direct	Recoil	Crankcase	270	Vanguard 300	Yes	130	45 x 28 x 29
HD 4.0/40 G	9.807-721.0	4.0	4000	Direct	Recoil	Crankcase	389	Honda GX390	No	149	45 x 28 x 29
HD 4.0/40 G	1.107-429.0	4.0	4000	Direct	Recoil	Crankcase	389	Vanguard 400	Yes	149	45 x 28 x 29
HD 4.0/40 Ge	9.807-722.0	4.0	4000	Direct	Electric	Crankcase	389	Honda GX390	No	158	45 x 28 x 29
HD 4.0/40 Ge	1.107-435.0	4.0	4000	Direct	Electric	Crankcase	389	Vanguard 400	Yes	158	45 x 28 x 29
HD 3.0/27 GB	9.807-723.0	3.0	2700	Belt	Recoil	Crankcase	196	Honda GX200	Yes	123	45 x 28 x 29
HD 3.5/35 GB	9.807-724.0	3.5	3500	Belt	Recoil	Crankcase	270	Honda GX270	No	156	45 x 28 x 29
HD 3.5/35 GB	1.107-422.0	3.5	3500	Belt	Recoil	Crankcase	270	Vanguard 300	Yes	156	45 x 28 x 29
HD 4.0/40 GB	9.807-725.0	4.0	4000	Belt	Recoil	Crankcase	389	Honda GX390	No	160	45 x 28 x 29
HD 4.0/40 GB	1.107-430.0	4.0	4000	Belt	Recoil	Crankcase	389	Vanguard 400	Yes	160	45 x 28 x 29
HD 4.0/40 GeB	9.807-726.0	4.0	4000	Belt	Electric	Crankcase	389	Honda GX390	No	196	45 x 28 x 29
HD 4.0/40 GeB	1.107-434.0	4.0	4000	Belt	Electric	Crankcase	389	Vanguard 400	Yes	196	45 x 28 x 29
HD 5.0/30 GB	9.808-252.0	5.0	3000	Belt	Recoil	Crankcase	389	Honda GX390	No	160	45 x 28 x 29
HD 5.0/30 GB	1.107-446.0	5.0	3000	Belt	Recoil	Crankcase	389	Vanguard 400	Yes	160	45 x 28 x 29

### ACCESSORIES

Order No.	Description
■ 8.750-247.0	Trigger Gun, model M407
■ 8.925-129.0	Hose, 50' x 3/8", 1w, TS, SOXSW
■ 8.783-039.0	Lance 30" Zinc plated, handle & coupler (for HD 3.0/27 AG, HD 3.0/27 AGB)
■ 8.783-040.0	Lance 44" Zinc plated, handle & coupler (for HD 3.4/35 G, HD 4.0/41 G, HD 4.0/41 Ge, HD 3.3/35 GB, HD 4.0/40 GB, HD 4.0/40 GeB)
■ 9.802-216.0	Injector, Chem, NON ADJ, 0.083
□ 8.712-429.0	Nozzle
□ 8.925-229.0	Legacy, 100' x 3/8" ID, 6000 PSI, 2-wire, smooth cover, black high pressure hose
□ 8.753-572.0	A+ Surface Cleaner SC21

### ACCESSORIES

Order No.	Description
□ 8.753-573.0	A+ Surface Cleaner SC24
□ 9.302-243.0	Legacy Turbo Nozzle, 4.0, 4350 PSI
□ 8.710-620.0	Legacy Superlite stainless steel, 72" - 56.0 oz
□ 9.807-754.0	Skid mount feet
□ 9.807-750.0	37.5" long handle
□ 9.807-753.0	Lance holder
□ 9.807-752.0	Hose storage hook
□ 9.807-751.0	Handle with hose reel
□ 8.929-509.0	Hose reel kit for direct driven machines
□ 8.929-511.0	Hose reel kit for belt driven machines

■ Included □ Optional \*CARB compliance required for sale in California

# HD SERIES GAS SKID

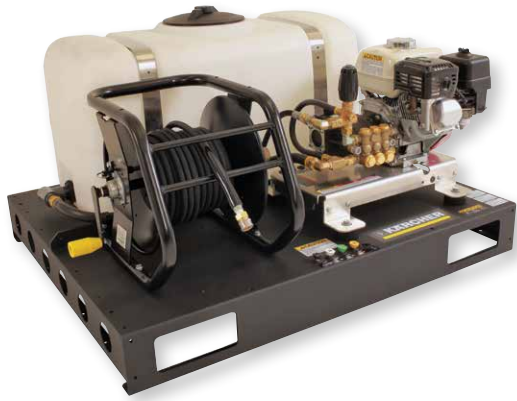

\*Pressure washer sold separate.

## Cleaning on the go.

The perfect accompaniment to Kärcher's HD Series Gas and Teton Series direct drive pressure washers - these mild steel skids offer two configurations:

1. Skid with a 50 gallon water tank and one 100' hose reel  
or
2. Skid with two 100' hose reels.

The HD Series Gas skids fit within a standard UTV / ATV bed and work with three different direct drive aluminum pressure washers to offer ultimate portability and usability for various applications.



## Features

- 50 gallon water tank (HD Pallet Skid with Tank only)
- Forklift holes
- Includes skid feet
- 1 to 2, 100' hose reels
- Fits within standard UTV/ATV bed
- Assembly required

## TECHNICAL DATA

Model	Part No.	Frame Material	Description	Compatible Pressure Washer (sold separately)	Ship Weight (lbs)	Ship Dimensions (L x W x H) Inches
HD Pallet Skid with Tank	9.807-833.0	Mild Steel	50 gal water tank and 1 hose reel	HD Series Gas direct drive HD 3.0/27 G (9.807-719.0) HD 3.5/35 G (9.807-720.0) HD 3.5/35 G (1.107-421.0) HD 4.0/40 G (9.807-721.0) HD 4.0/40 G (1.107-429.0) HD 4.0/40 Ge (9.807-722.0) HD 4.0/40 Ge (1.107-435.0)	185	40 x 48 x 35
HD Pallet Skid with 2 Hose Reels	9.807-838.0	Mild Steel	2 hose reels	Teton Series direct drive HD 3.0/27 G Teton (1.107-398.0) HD 4.0/40 G Teton (1.107-399.0) HD 4.0/40 Ge Teton (1.107-400.0) HD 3.5/35 G Teton (1.107-440.0)	172	40 x 48 x 35

## OPTIONS (FACTORY INSTALLED)

Order No.	Description
<input type="checkbox"/> 8.923-105.0	Rubber feet kit
<input type="checkbox"/> 8.923-107.0	Inlet filter kit
<input type="checkbox"/> 8.923-106.0	Lifting eye bolts kit
<input type="checkbox"/> 8.923-108.0	Three-way valve kit
■ Included □ Optional	

# HD CART



## Compact and dependable.

The HD Carts are tough gasoline-powered direct-drive cold water machines that deliver cleaning power of up to 4000 PSI. Built on compact sturdy steel frames, each unit features a dependable industrial-grade Honda engine, Kärcher crankcase pump, hose/gun rack, detergent injection, and tubed pneumatic tires.



## Features

- Steel frame with powder coat finish
- Commercial grade Honda GX engine
- Cleaning power up to 4000 PSI
- Industrial direct-drive Kärcher crankcase pump

## TECHNICAL DATA

Model	Part No.	GPM	PSI	Drive	CC	Engine	Pump	CARB*	Ship Weight (lbs)	Ship Dimensions (L x W x H) Inches
HD 2.3/24 P	1.575-100.0	2.3	2400	Direct	163	Honda GX160	Kärcher KP	Yes	130	35 x 21 x 24
HD 2.5/27 P	1.575-101.0	2.5	2700	Direct	196	Honda GX200	Kärcher KP	Yes	135	35 x 21 x 24
HD 3.0/30 P	1.575-102.0	3.0	3000	Direct	270	Honda GX270	Kärcher KP	No	175	35 x 21 x 24
HD 3.8/35 P	1.575-104.0	3.8	3500	Direct	389	Honda GX390	Kärcher KS	No	185	35 x 21 x 24
HD 3.5/40 P	1.107-223.0	3.5	4000	Direct	389	Honda GX390	Kärcher KS	No	188	35 x 21 x 24

## OPTIONS (FIELD INSTALLED)

Order No.	Description
■ 9.801-026.0	100' EZEE Hose Reel kit (hose not Included)
■ Included □ Optional	*CARB compliance required for sale in California

# HD PB CART



## Reliable and professional.

Our cold-water series provides a broad selection of rugged belt-drive units, all with reliable Honda GX engines, which deliver cleaning volume of up to 3.7 GPM. Each model is certified to ETL safety standards and comes with a rugged steel chassis, cast iron belt pulley system, flat-free tires, and industrial-grade Kärcher crankcase pump.



## Features

- Powder coated steel chassis
- Reliable Honda GX engine
- Onboard hose and lance storage
- Water volume up to 3.7 GPM
- Industrial belt-drive Kärcher pump
- Flat-free tires
- Quick connect nozzles

## TECHNICAL DATA

Model	Part No.	GPM	PSI	Drive	CC	Engine	Fuel	Pump	CARB*	Ship Weight (lbs)	Ship Dimensions (L x W x H) Inches
HD 3.0/30 PB	1.575-152.0	3.0	3000	Belt	270	Honda GX270	Gas	Kärcher KB	No	225	45 x 26 x 24
HD 3.7/35 PB	1.575-154.0	3.7	3500	Belt	389	Honda GX390	Gas	Kärcher KM	No	250	45 x 26 x 24
HD 3.0/40 PB	1.575-155.0	3.0	4000	Belt	389	Honda GX390	Gas	Kärcher KM	No	250	45 x 26 x 24

\*CARB compliance required for sale in California

# HD PB / PEB / D CAGE



## Extra rugged and powerful.

Our roll cage models are the most powerful units in our cold water line, with cleaning power of up to 5000 PSI. Protected by either a rugged powder coated roll cage built of 1-1/4" steel or a corrosion-resistant stainless steel cage, these units feature powerful Vanguard, Honda or Kohler engines, tri-plunger oil bath Kärcher pumps, flat-free tires, and an extra rugged belt-drive assembly with notched V belts and cast iron pulleys.



Diesel model HD 3.4/30 D Cage with optional hose reel

## Features

- Belt-drive
- Rugged steel chassis & roll cage for PB and PEB models. Corrosion-resistant stainless steel frame for D Cage model only
- Honda, Vanguard or new Kohler engine - model HD 3.4/30 D Cage (Shown to the left)
- Electric start on dual-axle models
- Industrial belt-drive Kärcher pump with 7-year warranty
- Flat-free tires on all models

## TECHNICAL DATA

Model	Part No.	GPM	PSI	Drive	CC	Engine	Fuel	Pump	CARB*	Ship Weight (lbs)	Ship Dimensions (L x W x H) Inches
HD 3.7/35 PB Cage	1.575-205.0	3.7	3500	Belt	389	Honda GX390	Gas	Kärcher KM	No	350	42 x 26 x 30
HD 4.0/40 PB Cage	1.575-207.0	4.0	4000	Belt	479	Vanguard 16	Gas	Kärcher KT	Yes	470	42 x 26 x 30
HD 4.0/50 PeB Cage	1.575-200.0	4.0	5000	Belt	688	Honda GX630	Gas	Kärcher KX	Yes	495	42 x 26 x 30
HD 4.5/50 PeB Cage	1.575-201.0	4.5	5000	Belt	688	Honda GX690	Gas	Kärcher KX	Yes	500	42 x 26 x 30
HD 3.4/30 D Cage	1.107-373.0	3.4	3000	Belt	442	Kohler KD440	Diesel	LM3540R.3	Yes	195	50 x 40 x 50

## OPTIONS (FIELD INSTALLED)

Order No.	Description
<input type="checkbox"/> 9.801-028.0	100' EZEE Hose Reel kit, single axle (hose not Included)
<input type="checkbox"/> 9.801-029.0	100' Hose Reel kit, 5000 psi, double axle (hose not Included)
<input type="checkbox"/> 8.750-682.0	100' capacity Hose Reel fixed base (for HD 3.4/30 D Cage model only)
<input type="checkbox"/> 8.929-070.0	Skid feet (for HD 3.4/30 D Cage model only)

■ Included □ Optional \*CARB compliance required for sale in California

# HD 7.9/72-4 CAGE EC



## Maximum power in a compact package.

The HD 7.9/72-4 Cage Ec high pressure cleaner features one-button operation and an automatic pressure relief valve, making it easy to use, while delivering the most powerful cleaning performance in its class for a variety of applications.



### Features

- Built-in pressure relief valve reduces pressure in the hose, remaining flexible when the trigger gun is closed
- Pressure increases gradually when activating the trigger gun prevents sudden jolts
- Large wheels, crane hook and an optimal center of gravity ensure easy transportation, even over rough terrain

### TECHNICAL DATA

Model No.	Part No.	PSI	GPM	Max. Inlet Temp	Pump	Drive	Motor Rating	Ship Weight (lbs)	Ship Dimensions (L x W x H) inches
HD 7.9/72-4 Cage Ec	1.367-163.0	7,200	7.9	140° F	Crankshaft	E-Motor 460 V / 60 Hz	30 kW / 41 HP	699	51.9 x 29.4 x 43

### ACCESSORIES

Order No.	Item Description
■ 4.760-679.0	28" spray lance (up to 9,280 PSI)
■ 6.391-847.0	66' pressure hose (up to 8,990 PSI)
■ 5.765-263.0	Flat jet nozzle, 060
□ 2.637-017.0	Add-on kit pre pressure pump
□ 2.639-251.0	Shoulder support
□ 4.760-653.0	41" spray lance (up to 9,280 PSI)
□ 4.760-677.0	81" spray lance (up to 9,280 PSI)
□ 4.403-004.0	Hose coupling
□ 6.391-846.0	33' pressure hose (up to 8,990 PSI)
□ 6.391-019.0	100' pressure hose (up to 8,990 PSI)
□ 2.113-073.0	Flat jet nozzle, 075 (5,075 PSI)
□ 2.113-075.0	Flat jet nozzle, 095 (3,625 PSI)
□ 2.113-077.0	Flat jet nozzle, 120 (2,175 PSI)
□ 5.765-264.0	Point jet nozzle, 060
□ 2.113-074.0	Point jet nozzle, 075 (5,075 PSI)
□ 2.113-076.0	Point jet nozzle, 095 (3,625 PSI)
□ 2.113-078.0	Point jet nozzle, 120 (2,175 PSI)

■ Included □ Optional

### ACCESSORIES

Order No.	Item Description
□ 6.415-060.0	F9 power rotary jet (7,200 PSI)
□ 6.025-526.0	F9 power rotary jet repair kit
□ 6.392-401.0	33' pipe cleaning hose
□ 6.392-402.0	66' pipe cleaning hose
□ 6.392-403.0	100' pipe cleaning hose
□ 6.470-223.0	Foot valve
□ 6.025-527.0	Pipe cleaning nozzle, Standard 060
□ 6.025-528.0	Pipe cleaning nozzle, Quattro 060
□ 6.025-529.0	Pipe cleaning nozzle, Rotary 060
□ 2.643-577.0	FRI 50 Me industrial surface cleaner, 20"
□ 6.415-059.0	Nozzle kit for FRI 50 Me

# MOBILE HOT WATER GENERATOR



## Hot water heater.

For attaching to a cold water pressure washer.

Our Kärcher Series water heater provides supplemental heat to cold water machines, giving users the benefits of hot water cleaning when it's needed. An electric-powered, diesel heated unit, the Heater 5.0/30 Ed effectively heats water at a rate of up to 5 gallons per minute.



## Features

- Effective heating of up to 5 GPM
- Heavy-duty, steel cabinet protected by an epoxy powder coat finish
- Portable

## TECHNICAL DATA

Model	Part No.	GPM	PSI	Electrical	Amps	Heated By	Ship Weight (lbs)	Ship Dimensions (L x W x H) Inches
Heater 5.0/30 Ed	1.575-650.0	to 5	up to 3000	120V / 1ph	5	Diesel	330	35 x 47 x 50

# STATIONARY HOT WATER GENERATOR SERIES



Model 9452



Model 9462

## Heating modules.

The 9400 Series heating modules give customers the flexibility to “convert” a cold water pressure washer into a hot water unit. By attaching the heating module to a cold water pressure washer the pressurized water is now heated to produce all the benefits of hot water cleaning. The four models use fuel oil, diesel or natural gas to heat the water using Kärcher’s high-efficiency, vertical heating coil.



## Features

- Fuel burner types available: diesel, kerosene, home heating oil, natural gas, LP gas (optional)
- All models are equipped with a flow switch to control the burner
- Heavy-duty, steel cabinet

## TECHNICAL DATA

Model	Part No.	GPM	PSI	Volt / PH	CC	BTU / Hour	AMP	Fuel	Ship Weight (lbs)	Ship Dimensions (L x W x H) Inches
9450	1.103-905.0	10	3200	115/1	389	700,000	8	Oil-Fired	525	32.5 x 25 x 50.5
9452	1.103-906.0	10	3200	115/1	479	540,000	1	Natural - Gas- Fired	500	32.5 x 25 x 50.5
9460	1.103-907.0	10	3200	115/1	688	920,000	8	Oil-Fired	920	40.5 x 32 x 65
9462	1.103-908.0	10	3200	115/1	688	920,000	1	Natural - Gas- Fired	935	40.5 x 32 x 65

## OPTIONS (FIELD INSTALLED)

Order No.	Description
<input type="checkbox"/> 8.903-076.0	Natural-Gas to LP Conversion for Model 9452 (Factory Installed)
<input type="checkbox"/> 8.903-075.0	Natural-Gas to LP Conversion for Model 9462 (Factory Installed)
<input type="checkbox"/> 9.801-040.0	10" Natural Gas-Fired Draft Diverter for Model 9452
<input type="checkbox"/> 8.717-730.0	12" Natural Gas-Fired Draft Diverter for Model 9462
<input type="checkbox"/> 8.749-806.0	10" Power Dampener
<input type="checkbox"/> 8.753-171.0	12" Power Dampener
<input type="checkbox"/> 8.749-807.0	Power Dampener Wiring Harness

■ Included □ Optional



# MISSISSIPPI RECOVERY



## Siphon muddy waters away.

Stop wash water from flowing down a drain or away from your area by collecting the wastewater from pressure washing. As EPA laws become more prevalent and strive to conserve water quality, contract cleaners and construction sites will need to recover their wash water and runoff. Eliminate the problem with the Mississippi Recovery series that is capable of recovering and transferring up to 30 GPM of water and transferring to a holding tank. Its small footprint allows the Mississippi to be mounted on a trailer. Be fully in control of water flow with the optional water dikes and drain covers to stop water from flowing down a drain or away from your site. Comes standard with 50' feet of vacuum hose and a scupper head.



### Features

- 3 stage vacuum motor delivers 100 CFM 100" sealed lift vacuum
- Simple curbside controls for easy use
- Rated for water up to 120°F
- Compatible with hot water machines and surface cleaners
- Bolt-on mounting system configured on the base to mount to a trailer for portability from site to site or optional caster wheel kit
- Drain port and filter basket together to keep sludge from clogging

### TECHNICAL DATA

Model	Part No.	Electrical	Tank	Vac Motor	AMP	Recovery	Ship Weight (lbs)	Ship Dimensions (L x W x H) Inches
Mississippi Recovery	1.103-516.0	120V	27 Gallon	3 Stage 100 CFM 100" sealed lift	15	30 GPM	127	24 x 27 x 59

### ACCESSORIES

Order No.	Description
■ 8.618-451.0	50' of High Temp 2" Vacuum Hose
■ 8.928-850.0	Scupper Head

### OPTIONS (FIELD INSTALLED)

Order No.	Description
<input type="checkbox"/> 9.113-972.0	21" Vac Recovery Surface Cleaner
<input type="checkbox"/> 8.928-887.0	Caster Wheel Kit
<input type="checkbox"/> 8.925-858.0	Vacuum Discharge Hose Kit

### DRAIN COVERS AND WATER DIKES

Order No.	Description
<input type="checkbox"/> 8.751-135.0	Drain Cover, 36" x 36", 30oz PVC
<input type="checkbox"/> 8.751-136.0	Drain Cover, 48" x 48", 30oz PVC
<input type="checkbox"/> 8.751-137.0	Drain Cover, 48" x 48", Urethane
<input type="checkbox"/> 8.751-138.0	Water Dike, 10', 22oz PVC
<input type="checkbox"/> 8.751-139.0	Water Dike, 10', 40oz Urethane
<input type="checkbox"/> 8.751-140.0	Water Dike, 20', 22oz PVC
<input type="checkbox"/> 8.751-141.0	Water Dike, 20', 40oz Urethane

■ Included  Optional



# EB 30/1



## The quick clean-up tool.

This ultra-quiet and compact sweeper is perfect for quick clean-ups in busy and crowded areas. The rechargeable battery pack ensures safety by eliminating trip hazards. The EB 30/1 is built to handle small cleaning jobs in professional working environments.

### Designed for high-traffic environments

- Cordless electric sweeper designed for commercial applications
- Flexible and professional interim clean-up
- Powerful, rechargeable battery provides for up to 45 minutes of operation on hard surface and up to 30 minutes on carpet
- Extremely quiet operation allows for cleaning even during business hours, making it ideal for use in noise sensitive areas
- Optional high-speed battery charger available for complete charging in 50 minutes

### EB 30/1

#### TECHNICAL SPECIFICATIONS

<b>Cleaning path</b>	<b>in</b>	12
<b>Container capacity</b>	<b>in<sup>3</sup></b>	67
<b>Operating noise level</b>	<b>dBA</b>	56
<b>Battery runtime</b>	<b>min</b>	30 - 45
<b>Standard battery charge time</b>	<b>hr</b>	1
<b>Weight</b>	<b>lbs</b>	6
<b>Dimensions (L x W x H)</b>	<b>in</b>	10 x 12 x 43

#### EQUIPMENT

Order No.	Description
1.545-121.0	EB 30/1, lithium-ion battery-operated sweeper

#### ACCESSORIES

Order No.	Description
■ 6.654-328.0	Lithium-ion battery
■ 6.654-197.0	Quick battery charger for EB 30/1
■ 4.762-400.0	Cylindrical brush
□ 4.762-401.0	Cylindrical stiff red brush, for hard-wearing surfaces

■ Included □ Optional

# KM 70/20 C



## Superior performance with manual power.

Speedy sweeping and painless maintenance rolled into one convenient package. This sweeper provides superior sweeping performance in a compact manual push sweeper. It is built to be rugged and durable for long life.

### Fast and efficient

- Push sweepers are the easy way to clean paths, halls, sidewalks and warehouses quickly and conveniently
- Main cylindrical brush is driven by both wheels so that it sweeps equally well in either right or left turns

### Built to last

- Rugged metal pinion drive for long life
- Durable design

### Easy to use

- Height of cylindrical brush can be easily adjusted in five positions by a knob on the handle

## KM 70/20 C

### TECHNICAL SPECIFICATIONS

Cleaning path/width- main broom	in	19
Cleaning path/width with 1 sb	in	28
Cleaning path/width with 2 sb	in	36
Side broom diameter	in	13
Debris container capacity	gal	11
Practical productivity	sq. ft/hr	30,000
Weight	lbs	50.7
Dimensions (L x W x H)	in	51.2 x 30.14 x 40.7

### EQUIPMENT

Order No.	Description
1.517-106.0	KM 70/20 C, twenty eight inch walk-behind sweeper
1.517-107.0	KM 70/20 C 2SB, thirty six inch walk-behind sweeper, dual brushes

### ACCESSORIES

Order No.	Description
■ 6.966-005.0	Side broom, water-resistant bristles, extremely durable, suitable for all types of surfaces
■ 6.906-041.0	Main broom, water-resistant bristles, extremely durable, suitable for all types of surfaces
■ 4.040-772.0	Dust Filter
□ 2.640-908.0	Litter picker—for picking up waste

■ Included □ Optional

# KM 70/30 C BP ADV



## Efficient sweeping on hard or soft floors.

Fast and efficient for sweeping indoors or outdoors—on hard floor or carpet for those that need to get the job done right the first time. Rely on this sweeper to make quick work of any sweeping needs with its highly productive electronic driven broom. It also features active dust control for optimum air quality. User-friendly features such as an easy adjust broom height and an adjustable handle height make this a popular machine with those who use it.

### Productive sweeping

- Delivers fast, efficient sweeping for hard and soft floor surfaces
- 28 inch cleaning path

### We thought of you

- For a wide range of applications indoors and outdoors, with a particularly quiet battery drive system at 69 dBA
- Features Active Dust Control with a separate fan and flat pleated filter for dustless sweeping indoors
- Simple adjustment of the main cylindrical broom and side broom

## KM 70/30 C BP ADV

### TECHNICAL SPECIFICATIONS

Cleaning path/width- main broom	in	19
Cleaning path/width with 1 sb	in	28
Side broom diameter	in	13
Debris container capacity	gal	11
Practical productivity	sq. ft/hr	30,800
Operating noise level	dBA	59
Sweeping method	direct/overthrow	direct
Weight	lbs	105.8
Dimensions (L x W x H)	in	48.8 x 28 x 45.2

### EQUIPMENT

Order No.	Description
1.517-218.0	KM 70/30 C Bp Adv, twenty eight inch walk-behind sweeper

### ACCESSORIES

Order No.	Description
■ 6.966-005.0	Side broom, water-resistant bristles, extremely durable, suitable for all types of surfaces
■ 6.906-041.0	Main broom, water-resistant bristles, extremely durable, suitable for all types of surfaces
■ 6.904-367.0	Flat dust filter
□ 2.640-908.0	Litter picker—for picking up waste
□ 5.731-625.0	Filter element - plastic filter, water resistant, washable, saves maintenance costs
□ 6.907-041.0	Standard cylindrical broom - water-resistant universal bristles, extremely durable, suitable for all types of surfaces.

■ Included □ Optional

# KM 75/40 W BP



## Self-propelled for increased productivity.

Big enough to get the job done, but maneuverable to clean congested areas, count on the KM 75/40 W Bp for your sweeping needs. This machine provides the versatility to clean anywhere—carpet or hard floors, indoors or out. We built it to perform day in and day out in the toughest commercial applications.

### Highly productive

- Cleans effectively indoors and out for increased versatility
- Self-propelled, 30 inch cleaning path for increased productivity
- Easy to understand controls increase operator effectiveness
- Over throw sweeping system with an easily removed hopper make emptying quick and efficient

### Improved air quality

- Active dust control system provides better air quality
- Air is vacuumed through a high-efficiency automotive style filter
- Manual filter shaker for easy cleaning and consistent results
- Wet-sweep bypass for cleaning wet surfaces



## KM 75/40 W BP

### TECHNICAL SPECIFICATIONS

Cleaning path/width- main broom	in	22
Cleaning path/width with 1 sb	in	30
Side broom diameter	in	16.5
Debris container capacity	gal	10.5
Practical productivity	sq. ft/hr	36,328
Operating noise level	dBA	64
Sweeping method	direct/overthrow	overthrow
Weight	lbs	172
Dimensions (L x W x H)	in	56 x 30 x 46.5

### EQUIPMENT

Order No.	Description
9.840-739.0	KM 75/40 W Bp, thirty inch walk-behind sweeper

### ACCESSORIES

Order No.	Description
■ 8.631-173.0	Battery, 12V AGM 70 Ah
■ 8.629-377.0	Automatic shelf charger, 24V, 24A, 115V, standard on AGM models
■ 6.905-626.0	Side Broom, Soft Bristle
■ 6.906-884.0	Main Broom
■ 5.731-635.0	Flat pleated filter—plastic filter, water resistant, washable, reduces maintenance costs
□ 6.634-201.0	Red key
□ 6.905-625.0	Side broom, hard for heavy-duty cleaning
□ 6.906-885.0	Main Broom, Hard Bristle
□ 6.906-950.0	Anti-Static Rolling Brush
□ 2.641-571.0	Carpet Sweeping Kit (includes fluff filter, anti-static cylindrical brush and triple caster)
□ 6.906-886.0	Main cylindrical broom, soft/natural - specifically designed with natural bristles for sweeping fine dust on smooth indoor floors.

■ Included □ Optional

## KM 85/50 R BP



### Compact, agile and intuitive.

The KM 85/50 R Bp is a battery-powered ride-on sweeper perfect for confined and congested areas. Its compact design and high maneuverability make cleaning faster than ever in narrow corridors and around sharp corners. It is extremely easy to operate and maintain, and boasts impressive area performance outdoors.

#### Efficient filter system

- Polyester flat pleated filter
- Effective cleaning with dual scraper

#### Ergonomic design for enhanced performance and comfort

- Clear and simple operation for all components
- Easy, tool-free seat adjustment for operator comfort
- Adjustable rotation speed depending on type of dirt
- Drives through door openings as narrow as 36"



### KM 85/50 R BP

#### TECHNICAL SPECIFICATIONS

Cleaning path/width- main broom	in	24.2
Cleaning path/width with 1 sb	in	33.5
Cleaning path/width with 2 sb	in	41.3
Side broom diameter	in	16.5
Debris container capacity	gal	13.2
Practical productivity - 1 / 2 sb	sq. ft/hr	32,940 / 40,685
Operating noise level	dBA	69
Sweeping method	direct/overthrow	direct
Weight	lbs	555
Dimensions (L x W x H)	in	50 x 35 x 46

#### EQUIPMENT

Order No.	Item Description
9.841-453.0	KM 85/50 R Bp Wet, 1 side broom, shelf charger
9.841-454.0	KM 85/50 R Bp AGM, 1 side broom, shelf charger

#### ACCESSORIES

Order No.	Item Description
■ 4.762-430.0	Main brush, standard
■ 6.906-132.0	1-side brush, standard
■ 6.435-773.0	Pneumatic tire (1 each)
■ 5.731-585.0	Flat Filter complete
□ 6.435-431.0	Solid rubber non-marking wheel
□ 4.762-442.0	Main brush, soft
□ 4.762-443.0	Main brush, hard
□ 4.762-441.0	Main brush, antistatic
□ 6.905-626.0	Side brush, soft
□ 6.905-625.0	Side brush, hard
□ 2.852-499.0	Carpet cleaning kit
□ 2.852-321.0	Additional left side brush kit
□ 2.852-500.0	Warning beacon
□ 5.035-488.0	Home Base kit (adapter and cable hook)
□ 6.980-077.0	Double Hook (requires 5.035-488.0)

■ Included □ Optional

# KM 90/60 R BP ADV



## Built for tough environments.

Sweep large areas quickly with this highly maneuverable, ride-on sweeper that increase productivity and safety. This machine cleans multiple surfaces, from tough industrial flooring to soft carpet. Its innovative Tact filter cleaning system extends the filter life, saving you money.

### Highly productive sweeping

- Automatic, continuous sweeping
- Overthrow sweeping



## KM 90/60 R BP ADV

### TECHNICAL SPECIFICATIONS

Cleaning path/width- main broom	in	24.2
Cleaning path/width with 1 sb	in	35.4
Cleaning path/width with 2 sb	in	45.3
Side broom diameter	in	16.5
Debris container capacity	gal	16
Practical productivity - 2 sb	sq. ft/hr	47,520
Operating noise level	dBA	69
Sweeping method	direct/overthrow	direct
Weight	lbs	782
Dimensions (L x W x H)	in	64 x 38.5 x 49.5

### EQUIPMENT

Order No.	Description
9.841-246.0	KM 90/60 R Bp Adv, 1SB, 2 x 12V/225 Ah wet batteries, shelf charger
9.841-247.0	KM 90/60 R Bp Adv, 1SB, 2 x 12V/234 Ah AGM batteries, shelf charger
9.841-248.0	KM 90/60 R Bp Adv, 2SB, 2 x 12V/225 Ah wet batteries, shelf charger
9.841-249.0	KM 90/60 R Bp Adv, 2SB, 2 x 12V/234 Ah AGM batteries, shelf charger

### ACCESSORIES

Order No.	Description
■ 4.762-430.0	Main broom
■ 6.906-132.0	Side broom
■ 6.907-519.0	TACT Filter (2 required)
□ 5.035-488.0	Home Base kit (adapter and cable hook)
□ 6.980-078.0	Mop clip (requires 5.035-488.0)
□ 6.980-080.0	Bottle Hook (requires 5.035-488.0)
□ 6.907-023.0	Anti-static rolling brush
□ 4.762-443.0	Main cylindrical brush, hard
□ 4.762-442.0	Main cylindrical brush, soft/natural
□ 6.905-625.0	Side broom, hard for heavy-duty cleaning
□ 2.642-693.0	Side brush kit, left
□ 2.851-334.0	Carpet sweeping kit (includes anti-static rolling brush)
□ 2.642-989.0	Warning beacon revolving signal light
□ 6.414-532.0	Round filter - plastic filter, water-resistant, washable, saves maintenance costs. (Fits previous KM 90/60 R Bp without Tact)
□ 4.762-442.0	Main cylindrical brush, soft/natural—with natural bristles, ideal for sweeping fine dust on smooth surfaces both indoors and outdoors
□ 8.628-341.0	12V/225 Ah wet batteries
□ 8.622-843.0	Battery pack 234 Ah AGM, 3 required

■ Included □ Optional



# PUZZI™ 8/1 C



## Handy and compact for easy spot cleaning.

The handy, compact and powerful Puzzi™ 8/1 C spray extraction cleaner is ideal for small areas and interim cleaning with excellent cleaning results.

### Easy to use

- Foot switch makes it easy to turn on and off - no bending required
- Transparent dome lid for easy-to verify operation

### Easy to transport

- Swivel casters for easy maneuvering
- Lightweight - at less than 20 lbs., it can be carried up and down stairs without strain

### Smart features

- 8' high-pressure solution and vacuum hose
- Removable dirty water tank

## PUZZI™ 8/1 C

### TECHNICAL SPECIFICATIONS

<b>Solution/recovery capacity</b>	<b>gal</b>	2.1 / 1.8
<b>Operating noise level</b>	<b>dB(A)</b>	71
<b>Power cord length</b>	<b>ft</b>	33
<b>Vacuum</b>	<b>hp, stage</b>	1.5 hp
<b>Water lift</b>	<b>in</b>	88
<b>Pump pressure</b>	<b>psi</b>	14.5 - 43.5
<b>Flow rate</b>	<b>gpm</b>	0.26
<b>Weight</b>	<b>lbs</b>	22
<b>Dimensions (L x W x H)</b>	<b>in</b>	22.5 x 13 x 17.3

### EQUIPMENT

Order No.	Description
1.100-228.0	Puzzi™ 8/1 C, with 98-inch spray hose with integrated water feed and hand tool

### ACCESSORIES

Order No.	Description
■ 6.394-826.0	8-foot hose, complete with couplings
■ 4.103-000.0	Handhold complete
■ 4.103-001.0	Upholstery nozzle
□ 2.638-778.0	Window cleaning kit with 6.5Ft hose, (requires 2.389-293.0 coupler)
□ 4.130-083.0	Venetian blind kit (requires 6.389-293.0 coupler)
□ 4.130-444.0	Stair cleaning tool, 9-inch
□ 6.391-411.0	13-foot high pressure solution & vacuum hose
□ 4.130-117.0	Stone & hard surface nozzle
□ 4.762-219.0	Hard surface adapter for standard hand tool
□ 4.130-010.0	Crevice nozzle
□ 4.130-007.0	Carpet floor wand complete (240mm)
□ 4.762-014.0	Hard surface adapter for floor wand (240mm)

■ Included □ Optional

# BRC 30/15 C



## Compact, fast and simple extraction.

Get acquainted with the faster, simpler solution for small area extraction. The BRC 30/15 C is designed to productively clean carpet with less effort, resulting in time-saving productivity gains. In interest of simplicity this machine requires minimal service. It is lightweight and compact for ease of use and transportability.

### Compact deep cleaning solution

- High performance vacuum motor for faster drying time

### Extraction is no sweat

- Quiet, lightweight, easy to use
- Designed for minimal service

### Portable and mobile

- Large 10-inch non-marking wheels for easy transport and maneuverability
- Fold-down handle for easy transportation in any vehicle



## BRC 30/15 C

### TECHNICAL SPECIFICATIONS

Cleaning path/width	in	10.5
Solution/recovery capacity	gal	4.5 / 4
Operating noise level	dB(A)	77
Power cord length	ft	25
Vacuum	hp, stage	1.5, 3
Water lift	in	120
Pump pressure	psi	26
Flow rate	gpm	0.38
Weight	lbs	79
Dimensions (L x W x H)	in	23 x 14 x 28

### EQUIPMENT

Order No.	Description
1.008-058.0	BRC 30/15 C, 4 gallon carpet extractor

### ACCESSORIES

Order No.	Description
■ 8.621-604.0	Brush, chevron, 10-inch
■ 8.629-552.0	Brush, extractor, natural bristles
■ 8.631-030.0	Assembly, adapter (1/8"m x 1/4" fpt nipple)
□ 8.629-036.0	Hose and hand tool kit, bag included
□ 8.600-075.0	Adapter 1/8 to 1/4 quick-disconnect for accessory solution hose

■ Included □ Optional

# CADET™ 7



## Nothing matches the value and ease-of-use of the Cadet™ 7 self-contained extractor.

It is easy to see why the Cadet™ 7 is such a popular extractor. It has proven itself as a reliable, robust machine that deep cleans carpets to like-new. Operator controls are intuitive and ergonomic for hours of pain-free operation.

### Brilliant deep clean

- Efficiently deep cleans carpet
- Floating vacuum shoe for superior recovery

### Unmatched value

- The deep cleaning value choice
- Robust design built for reliability

### Easy-to-use

- No-hose design makes it simple to fill and empty
- Ergonomic design reduces operator fatigue

## CADET 7

### TECHNICAL SPECIFICATIONS

Cleaning path/width	in	15
Solution/recovery capacity	gal	7 / 7
Practical productivity	sq.ft/hr	2,100
Operating noise level	dBa	69
Power cord length	ft	50
Vacuum	hp, stage	1.5, 3
Water lift	in	120
Pump pressure	psi	90
Flow rate	gpm	0.57
Weight	lbs	87
Dimensions (L x W x H)	in	41 x 17.5 x 34

### EQUIPMENT

Order No.	Description
1.008-022.0	Cadet™ 7, seven gallon carpet extractor

### ACCESSORIES

Order No.	Description
<input type="checkbox"/> 9.808-240.0	Air quality MicroFilter™ kit for Clipper™ 12 / Admiral™ 8 / Cadet™ 7, includes 2 filters and stainless steel bracket
<input type="checkbox"/> 8.623-611.0	One air quality MicroFilter™ refill
<input type="checkbox"/> 8.623-411.0	Power cord

■ Included  Optional

# RANGER



## Workhorse durability and premium features at a competitive price.

Specifically designed for the budget hotel sector without sacrificing performance or reliability. This vacuum uses an energy efficient impeller style system that will make quick work of any cleaning job. Plus, the manual height adjustment means you can use it on different types of carpet, as well as hard floor surfaces with ease. For a professional vacuum that doesn't skimp on quality or features, choose the Ranger upright vacuum.

### Productivity in mind

- Flat to floor feature allows the vacuum to easily clean under beds and furniture
- Manual height adjustment for different types of flooring
- Breathe easier with the HEPA rated vacuum bag

### Low total cost of ownership

- Long life belt backed by a two-year warranty
- Safety mechanism prevents damage to vac extending life of brush
- Break-away foot pedal designed to prevent damage

## RANGER

### TECHNICAL SPECIFICATIONS

<b>Cleaning Path</b>	<b>in</b>	12
<b>Productivity (Practical)</b>	<b>sq. ft/hr</b>	2,510
<b>Dust Bag</b>	<b>qt</b>	5.6
<b>Power</b>	<b>W</b>	480
<b>Power Cord</b>	<b>ft</b>	25
<b>Noise Level</b>	<b>dBA</b>	78
<b>Weight</b>	<b>lbs</b>	13.4
<b>Dimensions (L x W x H)</b>	<b>in</b>	15 x 13 x 46

### EQUIPMENT

Order No.	Item Description
1.012-900.0	Ranger 12" upright vacuum

### ACCESSORIES

Order No.	Description
■ 8.600-495.0	12-inch brush roller
□ 8.645-209.0	HEPA filter bags, 10 pack

■ Included □ Optional

\* Ask about discounted pallet pricing.

## CVS 65/1 BP



### The carpet specialist for different carpet styles.

The CVS 65/1 BP Pack is an impressive battery-operated carpet sweeper. The 36V lithium-ion battery allows for up to 60 minutes of continuous operation, or 19,375 sq ft, on a single charge. The efficient, two-step filter system comprising of a pre-filter and a PTFE-coated flat pleated filter for dust classes L and M ensures dust-free working, while its low operating noise of just 56 dB(A) also allows for use in noise-sensitive areas.

#### Optimized sweeping

- High productivity - works on hard floors too!
- Big carpet surfaces can be cleaned up efficiently in short time

#### 36/75 Power+ Battery

- Easily note remaining battery capacity
- Productive and efficient use of the machine
- Possible to run several machines on the same battery platform



### CVS 65/1 BP

#### TECHNICAL SPECIFICATIONS

Cleaning path/width- main broom	in	18
Cleaning path/width with 1 sb	in	26
Side broom diameter	in	10
Debris container capacity	gal	5
Practical productivity	sq. ft/hr	19,375
Operating noise level	dB(A)	56
Sweeping method	direct/overthrow	direct
Weight	lbs	88
Dimensions (L x W x H)	in	30 x 26.5 x 21

#### EQUIPMENT

Order No.	Description
1.517-302.0	CVS 65/1 Bp Pack

#### ACCESSORIES

Order No.	Description
■ 2.445-075.0	Battery Power+ 36 V
■ 2.445-053.0	Fast Charger Battery Power+ 36 V
■ 2.886-002.0	Main broom antistatic
■ 2.884-355.0	Side brush standard
■ 6.907-449.0	Flat dust filter
□ 5.745-280.0	Pre-filter
□ 5.032-196.0	Homebase bag
□ 2.884-358.0	Set of 10 disposal bags

■ Included □ Optional

# NT 30/1 TACT TE



## Stronger and sturdier than ever.

This powerful vacuum cleaner picks up coarse dirt and liquids as well as large quantities of fine dust. Tact, the fully automatic cleaning system, cleans the filter with strong air blasts. It is ideal for long periods of uninterrupted use and constant high suction power. It is fully compliant with OSHA silica dust regulations.

### Tact system (Auto Filter Clean System)

- Blasts of air clean the filter resulting in lower maintenance costs and a longer filter life ultimately saving you money

### Convenient and easy to use

- On-board storage for all accessories, includes two hooks for the suction hose and power cord
- No filters to install or remove
- Bayonet and clip connections guarantee easy and secure connection of all accessory parts to the vacuum



## NT 30/1 TACT TE

### TECHNICAL SPECIFICATIONS

Vacuum width, floor tool	in	14
Vacuum hose length	ft	13
Power cord length	ft	25
Waste container capacity	gal	8.2
Operating noise level	dBa	68
Air flow rate	cfm	150
Waterlift	in of water	102
Motor	watts	1,380
Weight	lbs	30
Dimensions (L x W x H)	in	22 x 14.5 x 22.2

### EQUIPMENT

Order No.	Description
1.148-216.0	NT 30/1 Tact Te, 8-gallon wet/dry vacuum with Tact

### ACCESSORIES

Order No.	Description
■ 2.889-192.0	Stainless steel vacuum tube set
■ 2.889-135.0	Vacuum hose 13 ft
■ 2.889-134.0	Vacuum hose 8 ft
■ 2.889-170.0	Ergonomic bend
■ 2.889-152.0	Wet and dry floor nozzle
■ 2.889-159.0	Crevice nozzle
■ 2.889-151.0	Power tool adapter
■ 2.889-154.0	Fleece filter bags - 30 liter
■ 6.907-629.0	HEPA filter

■ Included □ Optional

# NT 30/1 ACCESSORIES



## OPTIONAL ACCESSORIES

Order No.	Item Description
<input type="checkbox"/> 2.889-137.0	Vacuum hose 1-3/8 inch diameter (DN 35) 13 ft electrically conductive
<input type="checkbox"/> 2.889-136.0	Vacuum hose 1-3/8 inch diameter (DN 35) 8 ft electrically conductive
<input type="checkbox"/> 2.889-164.0	Vacuum hose 1-3/8 inch diameter (DN 35) 8 ft heat-resistant
<input type="checkbox"/> 2.889-172.0	Ergonomic bend 1-3/8 inch diameter (DN 35) with soft grip electrically conductive
<input type="checkbox"/> 2.889-148.0	Ergonomic bend 1-3/8 inch diameter (DN 35) with soft grip and vacuum power regulation
<input type="checkbox"/> 6.907-455.0	Flat pleated filter PTFE
<input type="checkbox"/> 2.679-000.0	Drilling dust nozzle 1-3/8 inch diameter (DN 35)
<input type="checkbox"/> 2.889-138.0	Vacuum hose 1-5/8 inch diameter (DN 40), 13 ft
<input type="checkbox"/> 2.889-139.0	Vacuum hose 1-5/8 inch diameter (DN 40), 8 ft
<input type="checkbox"/> 2.889-141.0	Vacuum hose 1-5/8 inch diameter (DN 40), 13 ft electrically conductive
<input type="checkbox"/> 2.889-140.0	Vacuum hose 1-5/8 inch diameter (DN 40), 13 ft oil-resistant
<input type="checkbox"/> 2.889-171.0	Ergonomic bend 1-5/8 inch diameter (DN 40), with soft grip
<input type="checkbox"/> 2.889-172.0	Ergonomic bend 1-5/8 inch diameter (DN 40), with soft grip electrically conductive
<input type="checkbox"/> 2.889-194.0	Set of vacuum tubes 1-5/8 inch diameter (DN 40), 2 x 1.8 ft, stainless steel
<input type="checkbox"/> 6.907-629.0	HEPA filter (standard)
<input type="checkbox"/> 2.889-174.0	Wide wet and dry floor nozzle with easily changeable inserts for wet/dry applications
<input type="checkbox"/> 2.889-192.0	Stainless steel vacuum tube set, 35mm
<input type="checkbox"/> 2.889-170.0	Ergonomic bend, 35mm
<input type="checkbox"/> 2.889-152.0	Wet and dry floor nozzle, 35mm, 360mm wide
<input type="checkbox"/> 2.889-159.0	Crevice nozzle, 35mm
<input type="checkbox"/> 5.453-042.0	<b>(Photo 1)</b> Power tool adapter, fits these size shrouds: 1.06" - 1.10" OD, 1.25" - 1.32" OD, 1.37" - 1.44" OD, 1.47" - 1.50" OD
<input type="checkbox"/> 5.453-016.0	<b>(Photo 2)</b> Power tool adapter, fits these size shrouds: 1.06" - 1.07" OD, 1.27" - 1.30" OD, 1.40" - 1.41" OD
<input type="checkbox"/> 5.407-108.0	<b>(Photo 3)</b> Power tool adapter: connects to 40mm hose connection, screws into 35mm hose or 5.453-016.0 tool adapter
<input type="checkbox"/> 2.637-217.0	<b>(Photo 4)</b> Power tool "Y" adapter
<input type="checkbox"/> 5.453-085.0	<b>(Photo 5)</b> Power tool adapter sleeve 40 x 50 mm
<input type="checkbox"/> 5.407-113.0	<b>(Photo 6)</b> Reducer, DN 40 to DN 35 hose connection
<input type="checkbox"/> 5.031-703.0	Tension ring (order with 5.407-113.0)

■ Included □ Optional

# NT 48/1



## A tough and versatile clean.

This machine is a tough and versatile wet/dry vacuum. Built to handle difficult wet or dry dirt, this vac is the machine that will stand up to tough everyday use. The optional front mounted squeegee provides even more productive water pickup. The large filter provides impressive suction power and long work intervals improving your productivity.

### Portable

- Mobile, all-purpose wet/dry vacuum for small to medium jobs and multiple locations
- Integrated handle ensures easy and comfortable transport

### Real-world convenience

- Optional front mounted squeegee for more productive pickup

## NT 48/1

### TECHNICAL SPECIFICATIONS

Vacuum width, floor tool	in	12
Vacuum hose length	ft	8
Power cord length	ft	25
Waste container capacity	gal	12
Operating noise level	dba	72
Air flow rate	cfm	142
Waterlift	in of water	80
Motor	watts	1,380
Weight	lbs	22
Dimensions (L x W x H)	in	19 x 15.3 x 30.3

### EQUIPMENT

Order No.	Description
1.428-623.0	NT 48/1, 13-gallon wet/dry vacuum
9.840-844.0	NT 48/1, 13-gallon wet/dry vacuum with front mounted squeegee

### ACCESSORIES

Order No.	Description
■ 6.414-789.0	Cylindrical dust filter
■ 6.904-285.0	Paper filter bag (5-pack, 1 bag Included with machine)
■ 6.906-512.0	All-purpose nozzle
■ 6.900-385.0	8.3-inch all purpose crevice nozzle
■ 4.440-626.0	8 feet x 1.375 inch hose with comfortable hand grip
■ 6.900-514.0	Metal suction tube, 1.4 inch X 1.6 feet
■ 6.906-240.0	Crevice nozzle, 1.4-inch
□ 6.904-211.0	Wet filter bag
□ 6.906-384.0	14.6-inch aluminum all-purpose nozzle with height-adjustable cylindrical, brush strips and oil resistant squeegees
□ 6.907-409.0	10.2-inch plastic all-purpose nozzle
□ 6.907-408.0	14.2-inch plastic all-purpose head with cylindrical, brush strips and standard squeegee
□ 6.906-383.0	17.7-inch aluminum all-purpose head with height-adjustable cylindrical, brush strips and oil resistant squeegees
□ 2.860-113.0	Upholstery hand tool
□ 2.860-114.0	10-inch turbo nozzle with reducer 35/32
□ 6.903-033.0	11.4-inch crevice tool
□ 6.905-988.0	4.7-inch plastic Upholstery Nozzle, 35 mm ID
□ 6.903-034.0	Radiator brush for use with 6.900-385.0
□ 6.903-035.0	Plastic, pipe diameter 3.9"
□ 6.903-862.0	Suction brush, natural hair, pivotable, 35 mm ID
□ 2.860-116.0	Nozzle set, crevice tool, upholstery tool, round brush, 35 mm ID
□ 2.863-147.0	All-Purpose brush, soft bristles 35 mm ID
□ 8.622-960.0	Replacement 15-inch squeegee blade

■ Included □ Optional



# NT 68/1



## Utility with ease.

Easily tackle medium to large jobs with this wet/dry vac. Designed with a robust 1.8 hp vac motor to handle any task you throw at it. If even more productivity is desired, the optional front mounted squeegee makes quick work of water recovery. Thoughtful features such as no-tipping dumping and on-board storage make this the operator's choice for wet/dry vacs.

### Performance

- Optional front-mounted squeegee offers more productive water pick-up
- 18 gallon capacity offers easy mobility for medium to large jobs

### Thoughtful design

- Complete with on-board tool storage compartment with safety sign storage bracket
- Self-adjusting squeegee assembly

## NT 68/1

### TECHNICAL SPECIFICATIONS

Vacuum width, floor tool	in	24.5
Power cord length	ft	50
Waste container capacity	gal	18
Operating noise level	dBA	71
Air flow rate	cfm	142
Waterlift	in of water	80
Motor	watts	1,200
Weight	lbs	64
Dimensions (L x W x H)	in	35.5 x 24.5 x 37.5

### EQUIPMENT

Order No.	Description
1.103-494.0	NT 68/1, eighteen gallon wet/dry vacuum with 24" front squeegee, with tools
1.103-495.0	NT 68/1, eighteen gallon wet/dry vacuum with 24" front squeegee
1.013-021.0	NT 68/1, eighteen gallon wet/dry vacuum with hose and wand only

### ACCESSORIES

Order No.	Description
<input type="checkbox"/> 5.731-595.0	Cartridge filter (wet)
<input type="checkbox"/> 6.414-552.0	Cartridge filter (dry)
<input type="checkbox"/> 6.900-385.0	8.3-inch all purpose crevice nozzle
<input type="checkbox"/> 6.906-240.0	Crevice nozzle, 1.4-inch
<input type="checkbox"/> 6.906-384.0	14.6-inch aluminum all-purpose nozzle with height-adjustable cylindrical, brush strips and oil resistant squeegees
<input type="checkbox"/> 6.907-409.0	Floor tool package: 10.2-inch plastic all-purpose nozzle, basalt grey
<input type="checkbox"/> 6.903-018.0	14.6-inch aluminum all-purpose head with height-adjustable cylindrical, brush stripes and squeegee blades
<input type="checkbox"/> 6.907-408.0	Floor tool package: 14.2-inch plastic all-purpose head with cylindricals, brush strips and standard squeegee, basalt grey
<input type="checkbox"/> 6.906-383.0	17.7-inch aluminum all-purpose head with height-adjustable cylindrical, brush stripes and oil-resistant squeegees
<input type="checkbox"/> 2.860-113.0	Upholstery hand tool
<input type="checkbox"/> 2.860-114.0	10-inch turbo nozzle with reducer 35/32
<input type="checkbox"/> 6.903-033.0	11.4-inch crevice tool
<input type="checkbox"/> 6.900-922.0	14.6-inch crevice nozzle, metal
<input type="checkbox"/> 6.902-154.0	Wand
<input type="checkbox"/> 8.635-292.0	Front mount squeegee assembly
<input type="checkbox"/> 6.906-512.0	Squeegee head
<input type="checkbox"/> 8.634-534.0	Replacement squeegee blades (two required)

■ Included □ Optional

# BV/VAC PAC™ HEPA SERIES



## Breathe easy with HEPA filtration.

The BV/VAC PAC HEPA series are portable back mounted vacuums great for increasing productivity, efficiency, while saving you money. Breathe easier with HEPA-level filtration standard on these vacuums. They also have an ergonomic harness system, allowing the operator to move around quickly and easily for maximum productivity.

### Meets your needs

- HEPA filtration is now standard, providing optimum air quality by filtering with 99.9% effectiveness to 0.3 microns
- Vacuum hose is a top-mounted swivel design for left-hand and right-hand operation



### BV 7/1 VAC PAC 6 HEPA

### BV 11/1 VAC PAC 10 HEPA

#### TECHNICAL SPECIFICATIONS

Specification	Unit	BV 7/1 VAC PAC 6 HEPA	BV 11/1 VAC PAC 10 HEPA
Vacuum width, floor tool	in	13	13
Vacuum hose length	ft	60	60
Power cord length	ft	50	50
Waste container capacity	qt	6	10
Operating noise level	dBa	67	67
Air flow rate	cfm	112	112
Waterlift	in of water	104	104
Motor	watts	1,200	1,200
Weight	lbs	10	11
Dimensions (L x W x H)	in	8.5 x 8.8 x 19.8	8.5 x 8.8 x 23.7

#### EQUIPMENT

Order No.	Description
1.014-013.0	BV 7/1 VAC PAC 6 HEPA backpack vacuum, 6 qt. (includes hose and tool kit)
1.014-014.0	BV 11/1 VAC PAC 10 HEPA backpack vacuum, 10 qt. (includes hose and tool kit)

#### ACCESSORIES

Order No.	Description
■ 8.628-666.0	Aluminum double curve wand, 2 PC
■ 8.619-894.0	Hose assembly
■ 8.639-285.0	HEPA pleated filter
■ 8.619-884.0	Cloth bag for VAC PAC™ HEPA 10 / BV 11/1
■ 8.619-885.0	10-quart paper bags, 10-pack for BV 11/1
■ 8.619-891.0	Paper bags for VAC PAC™ HEPA 6 / BV 7/1
■ 8.619-890.0	Cloth bags for VAC PAC™ HEPA 6 / BV 7/1
■ 8.619-887.0	Filter dome
■ 8.604-141.0	VAC PAC™ tool kit (#02293 crevice tool, #02083 dusting brush, #02084 upholstery tool, #02085 upholstery tool brush, #02086 extension tube)
□ 8.628-451.0	Crevice tool
□ 8.600-008.0	5-inch upholstery tool
□ 8.628-360.0	Upholstery brush
□ 8.600-007.0	3-inch dusting tool with adapter
□ 8.628-445.0	Carpet tool
□ 8.628-444.0	Bristle shod dry pick-up tool
□ 8.619-876.0	VAC PAC™ crevice tool
□ 8.631-254.0	Harness assembly for VAC PAC™ HEPA 6 & 10 and BV 11/1
□ 8.642-914.0	15-inch sidewinder carpet tool with 1.5-inch neck
□ 8.642-915.0	15-inch sidewinder hard floor brush with 1.5-inch neck
□ 8.642-916.0	18-inch sidewinder carpet tool with 1.5-inch neck
□ 8.642-917.0	18-inch sidewinder hard floor brush with 1.5-inch neck

■ Included □ Optional

# BR 35/12 C BP



## The race is always won in the corners.

Thanks to our innovative steerable scrub deck, the BR 35/12 C Bp can clean up to the wall at a 90° angle. It can also clean in reverse, or in any direction. The height-adjustable, telescoping steering column allows optimal ergonomics for any operator. The folding steering column also makes it easy to secure for transport.

### Steer your way to cleaner floors

- Our innovative steerable scrub deck allows for scrubbing in any direction, and provides perfect scrubbing right up to the edge
- The telescoping handle adjusts to any operator's height
- Brush height is adjustable for multiple floor types
- Kärcher's unique ecoefficiency mode features increases operating time by 50%, and reduces noise by 40%



## BR 35/12 C BP

### TECHNICAL SPECIFICATIONS

Cleaning path/width	in	14
Brush type	cylindrical/disc/pad	cylindrical
Brush quantity	units	1
Brush diameter	in	3.8
Suction bar (squeegee) width	in	18
Drive	pad-assist/traction	brush-assist
Solution/recovery capacity	gal	3 / 3
Theoretical/practical productivity	sq. ft/hr	11,000 / 6,600
Operating noise level - std/Eco! mode	dBA	66 / 62
Battery charger	shelf/on-board	on-board
Battery runtime - std/Eco! mode	min	66 / 90
Battery charging time	hrs	1-3
Battery lifetime-est charging cycles	x thousands	3
Brush contact pressure	lbs	29
Brush speed	rpm	700 - 1,050
Vac motor rating	watts	280
Vac motor suction	cfm	42
Waterlift	in of water	32
Weight with batteries	lbs	77
Dimensions (L x W x H)	in	39 x 18 x 51

### EQUIPMENT

Order No.	Description
1.783-470.0	BR 35/12 C Bp, fourteen inch scrubber with cylindrical brushes

### ACCESSORIES

Order No.	Description
■ 4.037-031.0	Cylindrical brush, red, medium
□ 4.037-036.0	Cylindrical brush, white, soft
□ 4.037-037.0	Cylindrical brush, orange, high/low
□ 4.037-038.0	Cylindrical brush, green, hard
□ 4.037-039.0	Cylindrical brush, black, very hard
□ 4.762-009.0	Cylindrical pad cylindrical shaft
□ 6.369-053.0	Cylindrical pads on sleeve, yellow, soft
□ 6.369-047.0	Cylindrical pads on sleeve, red, medium
□ 6.369-052.0	Cylindrical pads on sleeve, green, hard
□ 4.037-040.0	Cylindrical microfiber pad, for daily cleaning of delicate surfaces including LVT and stone tile
□ 4.037-127.0	Squeegee blade set, optional, Linatex
■ 4.037-035.0	Squeegee blade set, standard, oil-resistant, polyurethane
■ 6.654-294.0	Lithium-ion battery, 21 Ah

■ Included □ Optional

# BD 38/12 C BP



## Steer your way to cleaner floors.

Think of the BD 38/12 as a 15-inch disc version of the popular BR 35/12. The design allows for the easiest driving of a walk-behind disc scrubber on the market. The squeegee follows behind the disc to ensure 100% solution pickup even through the corners.

### Steerable, innovative disc scrubber

- Extremely agile for efficient cleaning of small and very furnished areas
- Easy to use—scrub right up to the wall

### Real world practicality

- Quick charging lithium-ion battery has a longer lifetime than normal batteries
- Very compact, light and easy to transport and roll over steps
- Application also in noise sensitive areas possible due of significantly reduced noise level



## BD 38/12 C BP

### TECHNICAL SPECIFICATIONS

Cleaning path/width	in	15
Brush type	cylindrical/disc/pad	disc
Brush quantity	units	1
Brush diameter	in	15
Suction bar (squeegee) width	in	16
Drive	pad-assist/traction	brush-assist
Solution/recovery capacity	gal	3.2 / 3.2
Theoretical/practical productivity	sq. ft/hr	11,210 / 6,725
Operating noise level - std/Eco! mode	dBA	65 / 62
Battery charger	shelf/on-board	on-board
Battery runtime - std/Eco! mode	min	60 / 120
Battery charging time	hrs	2 - 3
Battery lifetime-est charging cycles	x thousands	3
Brush contact pressure	lbs	35 - 46
Brush speed	rpm	180 / 150
Vac motor rating	watts	280
Vac motor suction	cfm	42
Waterlift	in of water	32
Weight with batteries	lbs	79
Dimensions (L x W x H)	in	37 x 30 x 51

### EQUIPMENT

Order No.	Item Description
1.783-431.0	BD 38/12 C, compact scrubber with fifteen inch disc brush

### ACCESSORIES

Order No.	Item Description
■ 6.907-151.0	Disc brush, red
■ 6.654-294.0	Lithium-ion battery, 21 Ah
■ 4.037-059.0	Squeegee blades, made from transparent and oil-resistant polyurethane, includes front and rear blade
□ 6.907-150.0	Pad driver plate
□ 6.369-003.0	Red disc pads, set of 5
□ 6.369-002.0	Green disc pads, medium soft, green, set of 5
□ 6.369-001.0	Black disc pads, hard, set of 5
□ 6.905-060.0	Disc microfiber pad, for daily cleaning of delicate surfaces including LVT and stone tile, set of 5

■ Included □ Optional

# BD 50/50 C CLASSIC BP



## Professional cleaning, now made easier.

This economically-designed scrubber provides you all the cleaning power to take on large jobs—perfect for retail environments, schools and health care facilities.

### Easy to use

- Three cleaning modes make it simple for any operator to get the job done right
- The slim design of the Kärcher BD 50/50 allows you to see in front of the scrubber easier
- Home Base kit allows for carrying of other essentials on the machines, for less visits to the supply closet

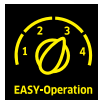

## BD 50/50 CLASSIC BP

### TECHNICAL SPECIFICATIONS

Cleaning path/width	in	20
Brush type	cylindrical/disc/pad	pad
Brush quantity	units	1
Brush diameter	in	20
Suction bar (squeegee) width	in	35
Drive	pad-assist/traction	pad-assist
Solution/recovery capacity	gal	13.2 / 13.2
Theoretical/practical productivity	sq. ft/hr	21,530 / 13,995
Operating noise level	dBA	66
Battery charger	shelf/on board	shelf
Brush contact pressure	lbs	59 - 62
Brush speed	rpm	180
Vac motor rating	watts	500
Vac motor suction	cfm	51
Waterlift	in of water	48
Weight with batteries	lbs	306
Dimensions (L x W x H)	in	47 x 21 x 39

### EQUIPMENT

Order No.	Description
9.841-369.0	BD 50/50 C Classic Bp, pad driver, 24V/105 Ah wet batteries
9.841-370.0	BD 50/50 C Classic Bp, pad driver, 24V/100 Ah AGM batteries

### ACCESSORIES

Order No.	Description
■ 4.762-534.0	Pad driver, 20 inch, features a quick-change coupling and centerlock
■ 4.777-179.0	V-Shaped squeegee, 35-inch, with caster, polyurethane
□ 4.905-027.0	Disc brush, soft, made of natural fibers, for cleaning and polishing
□ 4.905-029.0	Brush, hard black - For stubborn dirt and basic cleaning. For hard wearing surfaces.
□ 4.905-026.0	Disc brush, medium grit, red, for general cleaning (standard on brush machines)
□ 6.369-079.0	Red disc pad, 20-inch, medium soft red for cleaning all types of floors, 5 pack
□ 6.369-078.0	Green disc pad, 20-inch, aggressive for cleaning heavily soiled floors and for deep cleaning, 5 pack
□ 6.369-077.0	Black pad, 20-inch, hard, for cleaning heavily soiled floors and for deep cleaning, 5 pack
□ 6.369-468.0	Beige disc pad, 20-inch, light grit, for polishing and refreshing of hard and elastic smooth floor coverings, 5 pack
□ 6.273-023.0	Oil resistant, replacement squeegee blades
□ 6.371-146.0	Beige disc pad, 20 inch, soft, natural hair, for polishing
□ 4.777-401.0	Squeegee, 33.5 inch, straight, made of oil-resistant transparent polyurethane, for smooth floors
□ 5.035-488.0	Home base kit (adapter and cable hook)
□ 6.980-077.0	Double hook (requires 5.035-488.0)
□ 4.035-406.0	Home base kit carrying case
□ 6.980-078.0	Mop clip (requires 5.035-488.0)
□ 6.980-080.0	Bottle hook (requires 5.035-488.0)
□ 4.070-075.0	Universal hook
□ 8.641-483.0	Charger for wet batteries
□ 8.629-377.0	Charger for AGM batteries

■ Included □ Optional

# BD 70/75 W BP CLASSIC



## Smaller, but still mighty.

This economically-designed scrubber provides you all the cleaning power to take on large jobs—perfect for retail environments, grocery stores, municipalities, and BSC's.

### Easy to use

- Adaptable to specific floor type cleaning needs
- Large aluminum brush deck is tough and durable
- Wet, AGM and lithium battery options are available



### BD 70/75 W BP CLASSIC

#### TECHNICAL SPECIFICATIONS

Cleaning path/width	in	28
Brush type	cylindrical/disc/pad	pad
Brush quantity	units	2
Brush diameter	in	14
Suction bar (squeegee) width	in	41
Drive	pad-assist/traction	traction
Solution/recovery capacity	gal	19.8 / 19.8
Theoretical/practical productivity	sq. ft/hr	30,645 / 19,920
Operating noise level	dBA	63
Battery charger	shelf/on board	shelf
Brush contact pressure	lbs	66 - 150
Brush speed	rpm	180
Vac motor rating	watts	500
Vac motor suction	cfm	51
Waterlift	in of water	64
Weight with batteries	lbs	512 wet / 556 AGM
Dimensions (L x W x H)	in	57 x 30 x 42

#### EQUIPMENT

Order No.	Description
9.841-466.0	BD 70/75 W Bp Classic, 185 Ah wet batteries, shelf charger
9.841-467.0	BD 70/75 W Bp Classic, 190 Ah AGM batteries, shelf charger
9.841-240.0	BD 70/75 W Bp Classic, 24V lithium, shelf charger

#### ACCESSORIES

Order No.	Description
■ 4.762-590.0	Pad drive board STRONG (standard)
■ 6.369-003.0	Pad red, medium-soft (standard), set of 5
■ 8.663-291.0	Battery 6V/190 Ah AGM (standard with 9.841-467.0) (4 REQUIRED)
■ 8.622-835.0	Battery 6V/185 Ah wet (standard with 9.841-466.0) (4 REQUIRED)
■ 8.643-374.0	Shelf charger for 190Ah AGM batteries
■ 8.644-222.0	Shelf charger for 185Ah Wet batteries
■ 4.777-108.0	Squeegee, 1030mm (standard w/suction blades)
■ 4.037-144.0	Suction blades, 1030mm, blue (standard)
□ 4.905-010.0	Disc brush, red, medium
□ 4.905-013.0	Disc brush, black, hard
□ 4.905-012.0	Disc brush, natural, soft
□ 4.905-011.0	Disc brush, white, very soft
□ 4.037-145.0	Suction blades, 1030 mm (polyurethane)
□ 9.753-088.0	Squeegee transport plate
□ 4.444-015.0	Suction hose accessory
□ 2.644-140.0	Warning beacon add-on kit

■ Included □ Optional

# BD 80/100 W BP CLASSIC



## Quality and durability in a cost effective package.

This economically-designed scrubber provides you all the cleaning power to take on large jobs—perfect for retail environments, grocery stores, and BSC's.

### Easy to use

- Storage compartment in the back for shelf charger and other accessories
- An automatic brake is integrated into the transaxle and a cost effective, large aluminum brush deck is included

### BD 80/100 W BP CLASSIC

#### TECHNICAL SPECIFICATIONS

Cleaning path/width	in	32
Brush type	cylindrical/disc/pad	pad
Brush quantity	units	2
Brush diameter	in	16
Suction bar (squeegee) width	in	43
Drive	pad-assist/traction	traction
Solution/recovery capacity	gal	26.4 / 26.4
Theoretical/practical productivity	sq. ft/hr	35,025 / 22,770
Operating noise level	dBA	63
Battery charger	shelf/on board	shelf
Brush contact pressure	lbs	88 - 200
Brush speed	rpm	180
Vac motor rating	watts	600
Vac motor suction	cfm	53
Waterlift	in of water	67
Weight with batteries	lbs	705
Dimensions (L x W x H)	in	59 x 33 x 42

#### EQUIPMENT

Order No.	Description
9.841-456.0	BD 80/100 W Bp Classic, 295 Ah wet batteries, shelf charger
9.808-180.0	BD 80/100 W Bp Classic, 24V lithium, shelf charger
9.841-457.0	BD 80/100 W Bp Classic, 285 Ah AGM batteries, shelf charger

#### ACCESSORIES

Order No.	Description
■ 4.762-591.0	Pad drive board (standard)
■ 6.371-332.0	Pad, red, medium-soft (standard)
■ 8.629-184.0	Battery, Discover 6V/285 Ah AGM (standard with 9.841-457.0)
■ 8.644-818.0	Battery, Discover 24V lithium ion
■ 8.622-837.0	Battery, Trojan 6V/271 Ah wet (standard with 9.841-456.0)
■ 8.643-373.0	Shelf charger for wet batteries (standard with 9.841-456.0)
■ 8.643-374.0	Shelf charger for AGM batteries (standard with 9.841-457.0)
■ 4.777-102.0	Squeegee, 1100 mm (standard with suction blades)
■ 4.037-138.0	Suction blades, 1230 mm, blue (standard)
□ 4.905-000.0	Disc brush, red, medium
□ 4.905-032.0	Disc brush, black, hard
□ 4.905-031.0	Disc brush, natural, soft
□ 4.905-030.0	Disc brush, white, very soft
□ 4.037-140.0	Suction blades 1230 mm, transparent
□ 9.753-088.0	Squeegee transport plate
□ 2.644-140.0	Warning beacon add-on kit

■ Included □ Optional

# B 40 W BP



## Quiet, compact, innovative and customizable

We built this machine to be easy to operate, safe and easy to maintain. Our Kärcher Intelligent Key (KIK) and our advanced EASY operation are some of the many reasons why the B 40 W family offers a full spectrum of safety and protection for operators, machines and your floors.

### Complete control

- 100% control of the speed of your scrub brushes allows you to balance scrubbing power, noise levels and power consumption

### Interchangeable decks

- Choose disc and cylindrical decks from 17 to 22 inches
- Each can be changed quickly and without tools



		B 40 W DISC	B 40 W CYLINDRICAL
<b>TECHNICAL SPECIFICATIONS</b>			
Cleaning path/width	in	17 - 20	18 - 22
Brush type	cylindrical/disc/pad	disc	cylindrical
Brush quantity	units	1	2
Brush diameter	in	17 - 20	3.75
Suction bar (squeegee) width	in	33.5	33.5
Drive	pad-assist/traction	traction	traction
Solution/recovery capacity	gal	10.6 / 10.6	10.6 / 10.6
Theoretical productivity	sq. ft/hr	17,200 - 21,530	18,210 - 23,680
Operating noise level - std/Ecol mode	dBa	69 / 60	69 / 60
Battery charger	shelf/on-board	on-board	on-board
Brush contact pressure	lbs	135 - 160	80 - 86
Brush speed	rpm	180	1,200
Drive / vac motor rating	watts	130 / 500	130 / 500
Vac motor suction	cfm	47	47
Waterlift	in of water	48	48
Weight with batteries	lbs	307 - 384	307 - 384
Dimensions (L x W x H)	in	49 x 20.5 x 45	49 x 20.5 x 45

## EQUIPMENT

Order No.	Description
9.841-372.0	B 40 W Bp, traction drive, R 55 cylindrical scrub deck, 24V/105 Ah wet batteries
9.841-373.0	B 40 W Bp, traction drive, D 51 disc scrub deck, 24V/105 Ah batteries
9.841-374.0	B 40 W Bp, traction drive, R 55 cylindrical scrub deck, 24V/138 Ah AGM batteries
9.841-375.0	B 40 W Bp, traction drive, D 51 disc scrub deck, 24V/138 Ah AGM batteries

See Cleaning Heads & Brushes section for available scrub decks.



## B 40 W ACCESSORIES

### ACCESSORIES

Order No.	Description
■ 4.777-411.0	Curved squeegee assembly, 33.5 inches, with caster, polyurethane
■ 5.035-488.0	Home Base kit (adapter and cable hook)
■ 6.980-077.0	Double hook (requires 5.035-488.0)
■ 5.035-344.0	Operator key, yellow
■ 5.035-348.0	Foreman key, gray
□ 4.035-369.0	Lid with tank rinsing system
□ 4.035-345.0	Quick fill tank system (requires 9.083-003.0)
□ 9.083-003.0	Hose coupling
□ 6.273-207.0	Squeegee blade set, oil resistant (standard w/ 4.777-411.0)
□ 6.273-229.0	Squeegee blade set, anti stripe oil resistant
□ 6.273-290.0	Squeegee blade set, for textured floors
□ 6.273-213.0	Squeegee blade set, EPDM
□ 4.777-401.0	Squeegee assembly with straight polyurethane reversible blades
□ 4.777-416.0	Squeegee assembly with curved EPDM blades
□ 4.035-374.0	Home Base kit (includes mop support, mop clip and bottlehook)
□ 4.035-406.0	Home Base kit carrying case
□ 6.980-078.0	Mop clip (requires 5.035-488.0)
□ 5.035-655.0	Plate mop bracket
□ 5.035-656.0	Retaining bracket mop bracket
□ 6.980-080.0	Bottle hook (requires 5.035-488.0)
□ 4.035-408.0	Operator key, yellow, set of 5

■ Included □ Optional

Effective December 1, 2022. Prices, specifications and product descriptions subject to change without notice.

# B 80 W BP



## This large scrubber easily goes anywhere.

The B 80 W BP scrubbers cover a lot of area quickly, but are still easily maneuverable. They feature a robust, interchangeable, maintenance-friendly scrub deck. Choose from cylindrical or disc in 26" widths.

### Thoughtfully designed scrub decks

- Decks automatically raise and lower as necessary
- Interchangeable decks changed quickly and without tools

### Four color LCD screen

- Easily select your cleaning mode with the easy-to-read symbols on the large 4-color display



## B 80 W BP + R 65

## B 80 W BP + D 65

### TECHNICAL SPECIFICATIONS

		B 80 W BP + R 65	B 80 W BP + D 65
Cleaning path/width	in	26	26
Brush type	cylindrical/disc/pad	Cylindrical	Disc
Brush quantity	units	2	2
Suction bar (squeegee) width	in	39	39
Drive	pad-assist/traction	Traction	Traction
Solution/recovery capacity	gal	21 / 21	21 / 21
Theoretical/practical productivity	sq. ft/hr	27,980 / 18,180	27,980 / 18,180
Operating noise level - std/Eco! mode	dBa	69 / 66	69 / 66
Battery charger	shelf/on-board	On-board	On-board
Brush contact pressure	lbs	213	117
Brush speed	rpm	400 - 1,550	180
Drive/vac motor rating	watts	350 / 580	350 / 580
Vac motor suction	cfm	53	53
Waterlift	in of water	67	67
Weight (excluding battery/ with battery)	lbs	282 / 617	289 / 617
Dimensions (L x W x H)	in	61 x 29 x 45	62 x 29 x 45

### EQUIPMENT

Order No.	Description
9.841-204.0	B 80 W Bp, D 65 disc scrub deck, 24V/260 Ah wet batteries, with curved squeegee
9.841-198.0	B 80 W Bp, R 65 cylindrical scrub deck, 24V/225 Ah wet batteries, on-board charger, with curved squeegee
9.841-200.0	B 80 W Bp, R 65 cylindrical scrub deck, 24V/255 Ah AGM batteries, on-board charger, with curved squeegee
9.841-201.0	B 80 W Bp, D 65 disc scrub deck, 24V/255 Ah AGM batteries, on-board charger, with curved squeegee
9.841-203.0	B 80 W Bp, R 65 cylindrical scrub deck, 24V/260 Ah wet batteries, on-board charger, with curved squeegee

### ACCESSORIES

Order No.	Description
■ 4.777-080.0	Squeegee assembly, 39-inch, curved polyurethane oil-resistant blades, standard on machines with R 75 & D 75 scrub decks
■ 5.035-488.0	Home base kit (adapter and cable hook)
■ 6.980-077.0	Double hook (requires 5.035-488.0)
□ 8.600-251.0	Cable asm, bat. jumper x 15" (required w/ no battery units)
□ 4.035-345.0	Quick fill tank system (requires 9.083-003.0)
□ 9.083-003.0	Hose coupling
□ 6.273-205.0	Squeegee blade set, anti stripe oil resistant
□ 6.273-291.0	Squeegee blade set, for textured floors
□ 4.035-408.0	KIK key

See Cleaning Heads & Brushes section for available scrub decks.

# B 110 R



## Outstanding suction performance.

The brand-new B 110 R is perfect for all floors. The robust front bumper prevents damage to the machine and other objects, while speed dependent water supply saves on water and detergents. The newly designed squeegee picks up more water and requires less attention and the adjustable seat allows workers to feel more comfortable during long shifts.

### Advanced updates for a top-of-the-line machine

- Front bumper and driving lights
- Side scrub deck for close to the edge cleaning
- Adjustable comfort seat
- Hill driving assistant and automatic electronic brake



## B 110 R Bp

### TECHNICAL SPECIFICATIONS

Cleaning path/width	in	30
Brush type	cylindrical/disc/pad	Cylindrical and disc
Brush quantity	units	2
Brush diameter	in	4" cylindrical, 15" disc
Suction bar (squeegee) width	in	37
Drive	pad-assist/traction	Traction
Solution/recovery capacity	gal	29 / 29
Theoretical/practical productivity - 30" deck	sq. ft/hr	48,440 / 31,485
Operating noise level	dB(A)	59 - 74
Battery charger	shelf/on board	Shelf
Brush contact pressure	lbs	165
Brush speed	rpm	180 / 1200
Drive /vac motor rating	watts	600
Vac motor suction	cfm	53
Waterlift	in of water	68
Weight with batteries	lbs	1190
Dimensions (L x W x H)	in	65 x 30 x 52
Minimum turning radius	ft	2.87
Climbing ability - maximum slope	% grade	10
Max. working speed	mph	3.8

### EQUIPMENT

Order No.	Description
9.841-441.0	BD 75/110 R Bp Wet, 30" disc scrub deck
9.841-444.0	BD 75/110 R Bp AGM, 30" disc scrub deck
9.841-445.0	BR 75/110 R Bp Wet, 30" cylindrical scrub deck
9.841-449.0	BR 75/110 R Bp AGM, 30" cylindrical scrub deck

See Cleaning Heads & Brushes section for available scrub decks.

## B 110 R ACCESSORIES

### ACCESSORIES

Order No.	Description
■ 4.778-007.0	950 mm parabolic squeegee
■ 2.763-005.0	D 75 scrub deck (depending on model selected)
■ 2.763-047.0	R 75 scrub deck (depending on model selected)
■ 4.039-366.0	Linatex squeegee blade set
□ 4.035-605.0	Red brush for R 75 scrub deck
□ 6.907-731.0	Green brush for R 75 scrub deck
□ 6.907-732.0	Black brush for R 75 scrub deck
□ 6.907-730.0	Orange brush for R 75 scrub deck
□ 6.907-729.0	White brush for R 75 scrub deck
□ 4.039-357.0	Polyurethane replacement squeegee blade
□ 8.644-917.0	Right side scrub deck (factory install only)
□ 2.644-231.0	Spray suction kit
□ 4.039-350.0	Warning beacon kit
□ 4.039-327.0	Lid with tank rinsing
□ 2.644-245.0	Dose system
□ 4.035-406.0	Home base box
□ 4.039-349.0	Mop home base attachment kit
□ 8.622-835.0	Trojan T105 225 Ah battery
□ 8.632-254.0	Discover EVGT6A-A 255 Ah battery
□ 8.644-222.0	Shelf charger for wet batteries
□ 8.643-374.0	Shelf charger for AGM batteries

■ Included □ Optional

# B 150 R BP



## Race into efficiency with the B 150.

The B 150 R can cover up to 58,125 ft<sup>2</sup>/hr making this one impressively productive scrubber. Although it can cover large areas quickly, we made sure that it has great visibility for safety. Our KIK operating system and the color coded controls make operation simple and intuitive. KIK allows managers to control what functions and settings their employees can use and adjust.

### Advanced model features all-wheel drive (special order)

- Clean ramps with grades up to 18%
- Features a unique all-wheel brake system for safety
- Utilize the large color LCD screen to adjust everything to your needs including contact pressure, water volume, brush speed, etc.

### Let the machine do the work

- Auto tank-rinsing and auto-fill come standard to allow the operator to do other tasks while rinse and fill are taking place



		B 150 R + R 75	B 150 R + D 75	B 150 R + R 85	B 150 R + D 90
<b>TECHNICAL SPECIFICATIONS</b>					
Cleaning path/width	in	30	30	34	36
Brush type	cylindrical/disc/pad	Cylindrical	Disc	Cylindrical	Disc
Brush quantity	units	2	2	2	2
Brush diameter	in	3.5	7.5	3.5	17.7
Suction bar (squeegee) width	in	37	37	47	47
Drive	pad-assist/traction	Traction	Traction	Traction	Traction
Solution/recovery capacity	gal	40 / 40	40 / 40	40 / 40	40 / 40
Theoretical/practical productivity	sq. ft/hr	48,438 / 34,445	48,438 / 34,445	54,895 / 38,630	58,125 / 40,903
Operating noise level - std/Eco! mode	dBA	67 / 64	67 / 64	67 / 64	67 / 64
Battery charger	shelf/on board	Shelf	Shelf	Shelf	Shelf
Brush contact pressure	lbs	245	224	275	238
Brush speed	rpm	1,200	140	1,200	140
Drive /vac motor rating	watts	600 / 750	600 / 750	600 / 750	600 / 750
Vac motor suction	cfm	55	55	55	55
Waterlift	in of water	72	72	72	72
Weight without batteries	lbs	959 - 1,146	959 - 1,146	959 - 1,146	959 - 1,146
Dimensions (L x W x H)	in	65 x 31 x 56	65 x 31 x 56	65 x 31 x 56	65 x 31 x 56
Minimum turning radius	ft	2.9	2.9	2.9	2.9
Climbing ability - maximum slope	% grade	10	10	10	10
Max. working speed working	mph	3.7	3.7	3.7	3.7

### EQUIPMENT

Order No.	Description
9.841-286.0	B 150 R Bp, scrub deck sold separately, 36V/360 Ah batteries
9.841-287.0	B 150 R Bp 2SB, scrub deck sold separately, 36V/360 Ah batteries, dual side brushes
9.841-288.0	B 150 R Bp Advanced, scrub deck sold separately, 36V/360 Ah batteries (special order)
9.841-289.0	B 150 R Bp 2SB Advanced, scrub deck sold separately, 36V/360 Ah batteries, dual side brushes (special order)
9.841-290.0	B 150 R Bp, R 75 cylindrical scrub deck, 36V/360 Ah batteries
9.841-291.0	B 150 R Bp, R 75 cylindrical scrub deck, 36V/312 Ah AGM batteries
9.841-294.0	B 150 R Bp 2SB, R 75 cylindrical scrub deck, 36V/360 Ah batteries, dual side brushes.
9.841-295.0	B 150 R Bp 2SB, R 75 cylindrical scrub deck, 36V/312 Ah AGM batteries, dual side brushes.
9.841-292.0	B 150 R Bp, R 85 cylindrical scrub deck, 36V/360 Ah batteries.
9.841-293.0	B 150 R Bp, R 85 cylindrical scrub deck, 36V/312 Ah AGM batteries.
9.841-296.0	B 150 R Bp 2SB, R 85 cylindrical scrub deck, 36V/360 Ah batteries, dual side brushes.
9.841-297.0	B 150 R Bp 2SB, R 85 cylindrical scrub deck, 36V/312 Ah AGM batteries, dual side brushes.
9.841-367.0	B 150 R Bp, scrub deck sold separately, 36V/312 Ah AGM batteries
9.841-368.0	B 150 R Bp 2SB, scrub deck sold separately, 36V/312 Ah AGM batteries, dual side brushes
9.841-365.0	B 150 R Bp Advanced, scrub deck sold separately, 36V/312 Ah AGM batteries (special order)
9.841-366.0	B 150 R Bp 2SB Advanced, scrub deck sold separately, 36V/312 Ah AGM batteries, dual side brushes (special order)

## B 150 R BP ACCESSORIES

### ACCESSORIES

Order No.	Description
■ 4.778-007.0	Squeegee assembly, 37-inch, parabolic assembly with linatex blades, standard on machines with R 75 & D 75 scrub decks
□ 4.039-356.0	37" Linatex squeegee blades
□ 4.039-357.0	37" Polyurethane squeegee blades
□ 4.039-366.0	37" Mixed blades (front poly / rear Linatex)
■ 4.778-009.0	Squeegee assembly, 47-inch, parabolic assembly with linatex blades, standard on machines with R 85 & D 90 scrub decks
□ 4.039-362.0	47" Linatex squeegee blades
□ 4.039-363.0	47" Polyurethane squeegee blades
■ 8.622-842.0	6V/360 Ah wet batteries
■ 8.629-184.0	Battery, 6V/312 Ah AGM battery
■ 8.628-408.0	Battery charger, 36V, 36A, 115V (for use with 8.622-842.0)
■ 8.600-015.0	AGM battery charger, 36V, 21A, 115V
□ 2.642-058.0	Spray suction kit - for cleaning areas not easily accessed by machine (field installation required)
□ 6.435-733.0	Non-marking rear wheel, for use on sensitive floors that mark easily (field installation required)
□ 4.444-015.0	Suction hose accessories, for taking in water from corners (e.g. deep freezers)
□ 4.035-516.0	360° Warning beacon (field installation required)
□ 2.641-811.0	Cleaning agent dosing system DS 3 - can be directly connected to the main water supply; the fresh water tank is filled with the mixture of water and cleaning agent. Also in connection with the ABS filling system.
□ 6.435-810.0	Front tires, traction - with V profile and tire compound with especially good traction properties. Oil-proof.
□ 6.951-073.0	Replacement side broom, for use with R-type scrub decks (1-pack)

See Cleaning Heads & Brushes section for available scrub decks.

# CLEANING HEADS & BRUSHES

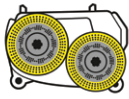

**D-Series**  
Disc Heads

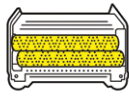

**R-Series**  
Cylindrical Heads

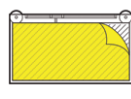

**S-Series**  
Vibration Heads

We offer three different scrub decks to suit your unique needs. The three types R (cylindrical), D (disc) or S (vibration) each have their specific advantages. Disc decks are ideal for everyday scrubbing. Cylindrical heads are ideal for stubborn dirt or uneven surfaces. The S heads are very efficient at stripping of floors. No matter your need, Kärcher has you covered.

## D 43 | 17-INCH DISC SCRUB DECK

Order No.	Description	B 40	B 60	B 80	B 150
2.763-023.0	D 43 head, 17-inch scrub deck for all battery-powered B 40 units	■			
4.762-533.0	Pad driver	■			
6.905-526.0	Disc microfiber pad, for daily cleaning of delicate surfaces including LVT and stone tile	■			
4.905-023.0	Disc brush, natural fibers	■			
6.369-470.0	Disc pad, red (general purpose/standard)	■			
4.905-022.0	Red disc brush, 17-inch	■			
4.905-024.0	Disc brush, white 17-inch	■			
4.905-025.0	Disc brush, black 17-inch	■			
6.369-472.0	Disc pad green (aggressive)	■			
6.369-473.0	Disc pad black (very aggressive)	■			
6.369-469.0	Disc pad white (soft)	■			
6.371-081.0	Disc pad beige (light aggregate)	■			
6.371-149.0	Disc pad, natural	■			

## D 51 | 20-INCH DISC SCRUB DECK

2.763-026.0	D 51 head, 20" / 510mm Scrub Deck for all Battery-Powered B 40 units	■			
8.642-710.0	One Time Conversion Kit, D 51 Orbital head (for serial # 10358 and higher)*	■			
8.638-801.0	Assembly, Deck, D 51 Orbital (replacement deck assembly)	■			
4.905-026.0	Disc brush, medium grit, red, for general cleaning (standard on brush machines)	■			
4.905-028.0	Disc brush, very soft, for cleaning sensitive floors and polishing, white	■			
4.905-029.0	Disc brush, hard, for stubborn dirt and deep cleaning. Only for hard-wearing surfaces, black	■			
4.905-027.0	Disc brush, soft, made of natural fibers, for cleaning and polishing	■			
4.762-534.0	Pad driver, 19 inch, features a quick-change coupling and centerlock (standard on pad driver machines)	■			
6.371-271.0	Disc microfiber pad, for daily cleaning of delicate surfaces including LVT and stone tile	■			
6.369-079.0	Red disc pad, 20-inch, medium soft red for cleaning all types of floors, 5-pack	■			
6.369-078.0	Green disc pad, 20-inch, aggressive for cleaning heavily soiled floors and for deep cleaning, 5-pack	■			
6.369-077.0	Black pad, 20-inch, hard, for cleaning heavily soiled floors and for deep cleaning, 5 pack	■			
6.369-468.0	Beige disc pad, 20-inch, light grit, for polishing and refreshing of hard and elastic smooth floor coverings, 5 pack	■			
6.371-146.0	Beige disc pad, 20 inch, soft, natural hair, for polishing	■			

\*For serial #10357 and lower, part number 6.613-512.3 must also be ordered

## D 55 | 22-INCH DISC SCRUB DECK

2.763-001.0	D 55 brush head, disc head, 22-inch		■		
4.905-015.0	Disc brush, white - soft		■		
4.905-016.0	Disc brush, natural bristles		■		
4.905-014.0	Disc brush, red, standard with D 55 head		■		
4.905-017.0	Disc brush, black - very aggressive		■		
4.762.445.0	Pad driver		■		
6.371-153.0	Disc pad, red (soft)		■		
6.371-154.0	Disc pad, green (medium)		■		
6.371-155.0	Disc pad, black (hard)		■		

## D 65 | 26-INCH DISC SCRUB DECK

2.763-003.0	D 65 brush head, disc head, 26-inch		■	■	
4.905-011.0	Disc brush, white - soft		■	■	
4.905-012.0	Disc brush, natural bristles		■	■	
4.905-010.0	Disc brush, red, standard with D 65 head		■	■	
4.905-013.0	Disc brush, black - very aggressive		■	■	
4.762-446.0	Pad driver		■	■	
6.369-003.0	Red disc pads, set of 5		■	■	
6.369-002.0	Green disc pads, medium soft, green, set of 5		■	■	
6.369-001.0	Black disc pads, hard, set of 5		■	■	
6.369-959.0	Disc microfiber pad, for daily cleaning of delicate surfaces including LVT and stone tile		■	■	

# CLEANING HEADS & BRUSHES

## D 75 | 30-INCH DISC SCRUB DECK

Order No.	Description	B 40	B 60	B 80	B 150
2.763-005.0	D 75 brush head, disc head, 30-inch			■	■
4.905-019.0	Disc brush, white - soft			■	■
4.905-020.0	Disc brush, natural bristles			■	■
4.905-018.0	Disc brush, red, standard with D 75 head			■	■
4.905-021.0	Disc brush, black - very aggressive			■	■
4.762-447.0	Pad driver			■	■
6.369-791.0	Disc pad, red (soft)			■	■
6.369-790.0	Disc pad, green (medium)			■	■
6.369-789.0	Disc pad, black (hard)			■	■
6.371-078.0	Disc microfiber pad, for daily cleaning of delicate surfaces including LVT and stone tile			■	■

## D 90 | 36-INCH DISC SCRUB DECK

2.763-008.0	D 90 brush head, disc, 36-inch				■
4.905-003.0	Disc brush, red, standard with D 90 head				■
4.905-004.0	Disc brush, natural bristles				■
4.905-005.0	Disc brush, white - soft				■
4.905-006.0	Disc brush, black - very aggressive				■
4.762-493.0	Pad driver				■
6.369-022.0	Disc pad, black - hard				■
6.369-023.0	Disc pad, green - medium				■
6.369-024.0	Disc pad, red - soft				■

## R 45 | 18-INCH CYLINDRICAL SCRUB DECK

2.763-020.0	R 45 head, 18-inch scrub deck for non-traction drive machines (for C Units)	■			
2.763-019.0	R 45 head, 18-inch scrub deck for traction drive machines (for W Units)	■			
4.762-392.0	Cylindrical red brush, medium stiff bristles for all-around cleaning on smooth and textured floors	■			
4.762-405.0	Cylindrical white brush, soft bristles for gentle cleaning on all-surface floors	■			
4.762-406.0	Cylindrical orange brush, high-low bristles for cleaning all grouted surface floors	■			
4.762-407.0	Cylindrical green brush, stiff bristles for aggressive cleaning on irregular surface floors	■			
4.762-408.0	Cylindrical black brush, extremely stiff bristles for stubborn dirt on rugged floors	■			
4.762-413.0	Cylindrical pad shaft (required for all brushes below)	■			
4.114-009.0	Cylindrical microfiber pad, for daily cleaning of delicate surfaces including LVT and stone tile	■			
6.367-105.0	Cylindrical pad, yellow (soft)	■			
6.367-107.0	Cylindrical pads, red, general purpose	■			
6.367-108.0	Cylindrical pad, white, (very soft) for high-gloss floors	■			
6.367-106.0	Cylindrical pad, green (hard & aggressive)	■			

## R 55 | 22-INCH CYLINDRICAL SCRUB DECK

2.763-013.0	R 55 head, 22-inch scrub deck for non-traction drive machines (for B 40 C units)	■			
2.763-011.0	R 55 head, 22-inch scrub deck for traction drive machines (for B 40 W)	■			
2.736-002.0	R 55 head, 22-inch scrub deck (for B 60 and 90 machines)		■		
4.035-184.0	Cylindrical red brush, 22-inch, medium stiff bristles, all-around cleaning on smooth and textured floors	■			
4.762-409.0	Cylindrical white brush, 22-inch, soft	■			
4.762-410.0	Cylindrical orange brush, 22-inch, high/low bristles for uneven floors	■			
4.762-411.0	Cylindrical green brush, 22-inch, hard bristles	■			
4.762-412.0	Cylindrical brush black 22-inch	■			
4.762-415.0	Cylindrical pad shaft, 22-inch, 2 required	■			
8.635-692.0	Cylindrical, stripping 22-inch	■			
4.114-010.0	Cylindrical microfiber pad, 22-inch, for daily cleaning of delicate surfaces including LVT and stone tile	■			
6.369-732.0	Yellow pad, 22-inch	■			
6.369-734.0	Red pad, 22-inch, medium grit for all-around cleaning on smooth and textured floors	■			
6.369-735.0	White pad, includes sleeve, 22-inch	■			
6.369-733.0	Green pad, 22-inch	■			
2.763-002.0	R 55 head, cylindrical, 22-inch		■		
6.906-977.0	Cylindrical brush, white, soft		■		
4.035-193.0	Cylindrical brush, red, standard with R 55 head		■		
6.906-978.0	Cylindrical brush, orange, hi-lo grout brush		■		
6.906-979.0	Cylindrical brush, green, hard		■		
6.906-980.0	Cylindrical brush, black, very aggressive		■		
8.635-692.0	Cylindrical, stripping 22-inch		■		
4.762-432.0	Cylindrical brush, red (2 required)		■		
6.369-389.0	White cylindrical pad, extra soft, set of 20		■		
6.369-454.0	Yellow cylindrical pad, soft, set of 20		■		
6.369-455.0	Green cylindrical pad, hard, set of 20		■		



# CLEANING HEADS & BRUSHES

## R 65 | 26-INCH CYLINDRICAL SCRUB DECK

Order No.	Description	B 40	B 60	B 80	B 150
2.763-004.0	R 65 brush head, cylindrical, 26-inch		■	■	
6.906-981.0	Cylindrical white brush, soft		■	■	
4.035-187.0	Cylindrical red brush		■	■	
6.906-982.0	Cylindrical orange brush, high-low for grout		■	■	
6.906-983.0	Cylindrical green brush, hard		■	■	
6.906-984.0	Cylindrical black brush, very aggressive		■	■	
4.762-433.0	Cylindrical Pad Shaft		■	■	
6.369-389.0	White cylindrical pad, extra soft, set of 20		■	■	
6.369-454.0	Yellow cylindrical pad, soft, set of 20		■	■	
6.369-455.0	Green cylindrical pad, hard, set of 20		■	■	
6.369-456.0	Red cylindrical pad, medium, set of 20		■	■	

## R 75 | 30-INCH CYLINDRICAL SCRUB DECK

2.763-006.0	R 75 brush head, cylindrical, 30-inch				■
6.906-985.0	Cylindrical brush, white, soft				■
6.907-415.0	Cylindrical brush, red, standard with R 75 head				■
6.906-986.0	Cylindrical brush, orange, hi-lo grout brush				■
6.906-987.0	Cylindrical brush, green, hard				■
6.906-988.0	Cylindrical brush, black, very aggressive				■
4.762-434.0	Cylindrical pad shaft				■
6.369-389.0	White cylindrical pad, extra soft, set of 20				■
6.369-454.0	Yellow cylindrical pad, soft, set of 20				■
6.369-455.0	Green cylindrical pad, hard, set of 20				■
6.369-456.0	Red cylindrical pad, medium, set of 20				■

## R 75 | 30-INCH ALUMINUM CYLINDRICAL SCRUB DECK

2.763-047.0	R 75 Aluminum brush head, cylindrical, 30-inch				■
6.907-729.0	Cylindrical white brush, soft, 30-inch				■
4.035-605.0	Cylindrical red brush, 30-inch				■
6.907-730.0	Cylindrical orange brush, high-low for grout, 30-inch				■
6.907-731.0	Cylindrical green brush, hard, 30-inch				■
6.907-732.0	Cylindrical black brush, very aggressive, 30-inch				■

## R 85 | 34-INCH ALUMINUM CYLINDRICAL SCRUB DECK

2.763-048.0	R 85 Aluminum brush head, cylindrical, 34-inch				■
6.907-772.0	Cylindrical white brush, soft, 34-inch				■
4.035-606.0	Cylindrical red brush, 34-inch				■
6.907-734.0	Cylindrical orange brush, high-low for grout, 34-inch				■
6.907-735.0	Cylindrical green brush, hard, 34-inch				■
6.907-734.0	Cylindrical black brush, very aggressive, 34-inch				■

## S 65 | 26-INCH VIBRATION SCRUB DECK

2.763-030.0	S 65 brush head, oscillating scrub deck, 26-inch		■	■	
4.036-063.0	S 65 orbital head connection kit, required for connecting S 65 orbital, B 60 and B 80 units (required)		■	■	
8.635-789.0	Pad, S 65 surface prep, package of 5		■	■	
8.635-788.0	Pad, S 65, red, package of 5		■	■	
8.635-836.0	Pad, S 65, white, package of 5		■	■	

# PS 4/7 BP OBC MISTER & ELECTROSTATIC SPRAYER

**Prevention is the best medicine.**



## PS 4/7 Bp OBC Mister

Achieve a higher level of efficacy with the Kärcher PS 4/7 Bp OBC Mister. This hospital-grade spraying system is specifically designed for use with Vital Oxide® disinfectant. Reduce the risks of Health Care Acquired Infections by killing virus, bacteria and mold faster, safer and more effectively.

## PS 4/7 Electrostatic Sprayer

- Our Electrostatic PS 4/7 sprayer adds the static charge to the particles to allow them to “wrap around” objects and provide even better coverage

## Vital Oxide

- No rinse sanitizer for food contact surfaces (D2) and kills harmful bacteria, mold and mildew, deodorizes and eliminates allergens
- Registered as a carpet disinfectant and recognized by CRI to be safe on carpets. EPA Est. No. 29909-CA-1 (See batch code for actual establishment number)

		PS 4/7 BP OBC MISTER	PS 4/7 ELECTROSTATIC SPRAYER
<b>TECHNICAL SPECIFICATIONS</b>			
Pressure	psi	100	100
Solution spray rate	gpm	0.05	0.05
Chemical tank	gal	1	1
Continuous spray on one battery charge	hrs	8	8
Voltage	V	12	12
Wheels	in	3	3
Compact height for storage/transport	in	20	20
Sound level	dBA	45	45
Continuous spray time (electrostatic)	min	N/A	110
Lithium battery	V	N/A	(2) 1.5V, AA size
Weight (including battery)	lbs	40	42
Dimensions (L x W x H)	in	20 x 15 x 38	20 x 15 x 38

## EQUIPMENT

Order No.	Description
1.007-084.0	PS 4/7 Bp OBC, mister
1.007-090.0	PS 4/7 Electrostatic sprayer with lithium battery

## ACCESSORIES

Order No.	Description
■ 8.639-048.0	Charger
■ 8.637-980.0	12V AGM battery
■ 8.704-694.0	Chemical pail pump
□ 8.644-738.0	Electrostatic sprayer kit (to be retrofitted on previously purchased PS 4/7 machines)

## DETERGENTS

Order No.	Description
□ 8.639-558.0	Vital Oxide,® 4 gallon - case, ready to use
□ 8.639-560.0	Vital Oxide,® 6 quart - case, ready to use
□ 8.644-292.0	Vital Oxide,® 5 gallon - pail, ready to use
□ 8.642-823.0	Vital Oxide,® 15 gallon - pail, ready to use
□ 8.698-112.0	Vital Oxide,® 55 gallon - drum, ready to use

■ Included □ Optional

# SG 4/4



## Clean without chemicals.

Time is money—particularly in commercial cleaning. The SG 4/4 steamer has an ingenious two-tank filling system allowing for continuous use. Steam cleaning can impressively remove bacteria without chemical. It is also ideal for cleaning kitchens and grout.

### Continuous use

- Our unique two-tank system allows for continuous use
- Very little time is needed to heat up the unit

### Adjust to your needs

- Control the level of steam
- Switch to pressurized hot water to remove stubborn dirt

### Designed for your health

- Only water is used by the SG 4/4 to save you money and to improve the health of users and guests

## SG 4/4

### TECHNICAL SPECIFICATIONS

<b>Voltage</b>	<b>V</b>	110
<b>Steam temp/pressure</b>	<b>°F/psi</b>	248 / 58
<b>Tank capacity</b>	<b>gal</b>	1.06
<b>Cable length</b>	<b>in</b>	24.5
<b>Weight without accessories</b>	<b>lbs</b>	17.6
<b>Dimensions (L x W x H)</b>	<b>in</b>	19 x 12.6 x 10.8

### EQUIPMENT

Order No.	Description
1.092-805.0	SG 4/4 commercial steam cleaner
9.841-414.0	SG 4/4 commercial steam cleaner with transport cart

### ACCESSORIES

Order No.	Description
■ 4.322-020.0	Steam hose
■ 4.127-024.0	Extension tube
■ 2.884-280.0	Hand tool
■ 6.906-185.0	Floor nozzle
■ 2.863-263.0	Power nozzle set
■ 2.884-281.0	Point jet nozzle
■ 4.013-030.0	Funnel
■ 2.863-264.0	Round brush set
□ 2.863-025.0	Window nozzle
□ 6.273-140.0	Wiper blade (window)
□ 2.863-062.0	Wallpaper stripper
□ 2.863-171.0	Steam+Clean microfiber cloth set for bathrooms (Includes 4 different cloths)
□ 2.863-172.0	Steam+Clean microfiber cloth set for kitchens (Includes 4 different cloths)
□ 2.863-173.0	Steam+Clean microfiber velour floor cloth set (Includes 2 cloths)
□ 2.863-174.0	Steam+Clean microfiber velour cloth covers for the hand tool (Includes 2 cloths)
□ 6.962-097.0	Filling funnel
□ 2.885-465.0	Floor tool replacement
□ 6.962-239.0	Two wheel transport cart

■ Included □ Optional

# SGV 6/5



## Hygiene, non-stop.

The easy-to-use SGV 6/5 steam vacuum cleaner offers hygienic cleanliness. A single machine that is a steam cleaner and wet vacuum cleaner in one. With EASY Operation switch, secure accessory integration and hand tool for controlling the steam/vacuum function.

### Straight forward operation

- One easy-to-use switch controls all operation
- Self-explanatory symbols means less training required

### Continuous operation

- Our unique design allows you to refill the water while in use

### Change on the go

- The included hand tool features an adjustment knob that allows you to adjust the water/steam regulation and turn the vacuum on and off

## SGV 6/5

### TECHNICAL SPECIFICATIONS

<b>Voltage</b>	<b>V</b>	110 - 120
<b>Steam temp/pressure</b>	<b>°F/psi</b>	327 / 87
<b>Tank capacity</b>	<b>gal</b>	1.3
<b>Cable length</b>	<b>ft</b>	24.5
<b>Weight without accessories</b>	<b>lbs</b>	86
<b>Dimensions (L x W x H)</b>	<b>in</b>	25 x 19 x 38

### EQUIPMENT

Order No.	Description
1.092-003.0	SGV 6/5 commercial steam cleaner and wet vacuum

### ACCESSORIES

Order No.	Description
■ 2.863-011.0	Round brush set, 3 brushes
■ 2.889-005.0	Floor nozzle, 12 inches
■ 2.889-006.0	Brush strips for floor nozzle 2.889-005.0
■ 2.889-007.0	Rubber strip, 12 inches for floor nozzle 2.889-005.0
■ 2.889-008.0	Hand nozzle
■ 2.889-009.0	Brush strip, 6 inches for hand nozzle 2.889-008.0
■ 2.889-010.0	Rubber strip, 6 inches for hand nozzle 2.889-008.0
■ 2.889-011.0	Adapter
■ 2.889-028.0	Crevice nozzle
■ 2.889-052.0	Adapter for attaching round brushes
■ 4.440-009.0	Steam suction hose
■ 2.889-004.0	Extension tube set (2 pieces)
□ 2.889-058.0	Extension tube (1 piece)
□ 2.889-053.0	Triangular floor nozzle
□ 2.863-007.0	Round brush stainless steel (very hard bristles) set, 3 nozzles
□ 2.863-008.0	Round brass brush (hard bristles) Set, 3 nozzles
□ 2.863-009.0	Pekalon round brush (medium-hard bristles) set

■ Included □ Optional

# SG BP GUM REMOVER



## Turn up the heat on gum removal.

The Kärcher SG 1 C Bp is a portable gum remover. Powered by a single lithium ion battery, this gum remover is quiet and offers up to 4 hours of uninterrupted operation. Gum is removed in 4-6 seconds, and it is safe to use on stone, concrete and even carpet. Great for maintaining shopping malls, schools, train stations, airports, hotels, hospitals, restaurants and supermarkets.

### Easy to Use

- SG1 C Bp's low pressure fuel canisters are designed to ensure delivery of proper fuel volume and safe operation

### Ultimate portability

- No cords ensures safety and convenience

### Environmentally friendly

- No harsh residue – safe on all surfaces



## SG 1 C BP

### TECHNICAL SPECIFICATIONS

<b>Run time</b>	<b>hrs</b>	4
<b>Weight</b>	<b>lbs</b>	11
<b>Dimensions (L x W x H)</b>	<b>in</b>	4.5 x 13 x 20.5

### EQUIPMENT

Order No.	Description
1.013-104.0	SG 1 C Bp backpack gum remover

### ACCESSORIES

Order No.	Description
<input type="checkbox"/> 8.639-871.0	Service pack: 2 LPG cartridges, 4 bottles of solution and 2 black stainless steel brushes, 1 green brush. Expect 8-9 hours run time.
<input type="checkbox"/> 8.642-880.0	Stainless steel brushes: 2 pack replacement stainless steel brushes (black)
<input type="checkbox"/> 8.640-136.0	Polypropylene brushes: 2 pack polypropylene brushes (green), for carpet and material
<input type="checkbox"/> 8.638-579.0	12-Pack of gas bottles
<input type="checkbox"/> 8.638-580.0	24 liters of gum remover solution
<input type="checkbox"/> 8.639-828.0	Charger
<input type="checkbox"/> 8.641-465.0	Battery
<input type="checkbox"/> 8.639-846.0	Lance & hose

■ Included □ Optional

# AB 84 CUL



## Reduce carpet drying times by up to 50%.

Powerful enough for any job yet economical enough to not break the bank; rely on the AB 84 CUL as your air blower of choice. If you have wet floors or carpet, dry your facility up to 50 percent faster so you can resume to business-as-usual sooner. This economical unit features three speeds as well as three different vertical standing positions so you can direct air anywhere you need to. The powerful 3,000 cfm air movement promotes rapid drying in no time.

- Three speeds of air movement for every type of job
- Sturdy four point motor mount to withstand heavy use and rough handling
- Built-in carpet clip for flood restoration jobs
- Three different three standing positions to allow air to be directed in any angle
- Upright handle and transport wheels for added safety and convenience

### AB 84 CUL

#### TECHNICAL SPECIFICATIONS

Air flow rate - level 1, 2, 3	cfm	3000 / 2500 / 2000
Fan speed - level 1, 2, 3	rpm	1600 / 1350 / 1050
Power cord length	ft	25
Motor rating	HP	0.5
Voltage	V	115
Weight	lbs	39
Dimensions (L x W x H)	in	22.8 x 16 x 21.5

#### EQUIPMENT

Order No.	Description
1.004-039.0	AB 84 CUL three-speed commercial air blower with collapsible handle

# BDS 51/175 C



## Strong, solid and robust operation.

The BDS 51/175 C floor machine is a high quality, durable unit that offer powers and versatility for scrubbing and stripping. It features an adjustable handle to accommodate various user heights and five inch non-marking wheels to allow easy transportation. This machine is available in single-speed or dual-speed.

### Floor Machine Built for Durability and Reliability

- Robust motor for everyday reliability
- Separate start and run capacitors for durability
- Cord strain relief to keep cord from breaking or tearing
- Strong and solid handle housing for trouble free operation

## BDS 51/175 C

### TECHNICAL SPECIFICATIONS

Pad size	in	20
Pad speed	rpm	175
Theoretical/practical productivity	sq.ft/hr	2,222
Operating noise level	dB(A)	63
Voltage	V	115
Motor	hp	1.5
Wheel diameter	in	5 x 1.25
Power cord length	ft	50
Weight	lbs	118
Dimensions (L x W x H)	in	24.5 x 21 x 47

### EQUIPMENT

Order No.	Description
1.009-103.0	BDS51/175 C, twenty-inch

### ACCESSORIES

Order No.	Description
■ 8.628-430.0	Pad driver, 20-inch with clutch plate
□ 8.645-238.0	Solution tank 4 gallon (Compatible with 1.009-102.0 & 1.009-103.0 models)
□ 8.600-507.0	Center lock
□ 8.628-369.0	20-inch aggressive grit brush with clutch plate
□ 8.628-378.0	20-inch mild grit brush with clutch plate
□ 8.628-379.0	20-inch nylon polish brush with clutch plate
□ 8.628-377.0	20-inch nylon scrub brush with clutch plate
□ 8.628-370.0	20-inch polypropylene brush with clutch plate
□ 8.625-259.0	20-inch sanding disc

■ Included □ Optional

# KÄRCHER DETERGENTS

Kärcher's detergents are highly concentrated and made with non-butyl blend of ingredients formulated to provide non-caustic, low-foaming detergent for a broad range of uses on many surfaces. They are engineered specifically to be metered through hot- or cold-water pressure washers with a high dilution ratio, making the cost-in-use very economical. Plus, our detergents are biodegradable.



## 1 Faster Results

Tested in the lab and in the field, to achieve results that are 3x faster than the original formula. With fast acting and efficient formulas, you'll use less product - saving you both time and money.

## 2 More Effective

Utilizing cutting-edge technology and enhanced raw materials, Kärcher detergents deliver superior cleaning results in even the toughest environments. Designed for a higher tolerance for hard water—less detergent is needed to break down the dissolved calcium and magnesium salts, leading to a marked reduction in insoluble mineral deposits commonly associated with hard water.

## 3 Environmentally Friendly

With an eye on preserving our natural resources, we are proud to offer a complete lineup of environmentally friendly detergents, many of which are phosphate-free. Rigorous testing has proven these new formulas to be effective while providing a sustainable solution for preventing the negative impacts often associated with runoff and providing you with peace of mind.



		Order no.		Size	pH	Color	Scent	Dilution	Foam	Hardness 1-5	Phosphate Free	Kosher Approved /Certified	Description
<b>General Purpose Cleaners: Formulated for general purpose cleaning. Designed for daily cleaning of facility surfaces, tools and floors.</b>													
General Purpose Cleaner	1	9.803-789.0		5 gal	10.2	purple	slight	1:128	low	5	■	■	General Purpose Cleaner is a blend of ingredients formulated to provide a low-foaming detergent for safe removal of dirt and grime off a broad range of surfaces. It is formulated to pass through a pressure washer without damaging the high-pressure pump. This formula is ideal for power washing around a home or shop, including exterior walls, decks, driveways, and roofs. It is also effective in cleaning machinery, equipment, cars, RVs, and trucks. It is safe for cleaning indoors or outdoors.
	2	9.803-791.0		55 gal	10.2	purple	slight	1:128	low	5	■	■	
<b>Automotive: Products designed specifically for soil conditions found on cars, vans and specifically vehicles with fine paint finishes. Effective and safe, phosphate free.</b>													
Auto Wash	3	8.698-143.0		5 gal	10.2	purple	slight	1:128	low	5	■	■	Auto Wash is a blend of ingredients formulated to provide a low-foaming detergent for safe removal of dirt and grime found on most vehicles. It is formulated to reduce water spots caused by hard water leaving a higher shine than most products. Auto Wash can pass through a pressure washer without damaging the high-pressure pump and is safe to use on aluminum, stainless steel, glass, plastic, paint and fine automotive finishes.
	4	8.698-144.0		55 gal	10.2	purple	slight	1:128	low	5	■	■	
<b>Vehicle: Detergent and care for both Automotive and Fleet use. Safe for both, non phosphate and superior results.</b>													
Vehicle Wash and Wax Detergent	5	9.803-726.0		5 gal	12.9	blue-green	floral	1:150	high	5	■	■	Vehicle Wash and Wax Detergent saves you time and money when you clean and protect in one step. Good for autos and trucks and safe on any finish. Superior performance in hard water leaving a shine with a spot free rinse.
	6	9.803-758.0		55 gal	12.9	blue-green	floral	1:150	high	5	■	■	
Vehicle Wax	7	8.698-147.0		5 gal	5.3	straw	musk	1:2000	non-foaming	1	■	■	Vehicle Wax. Added at the final rinse, Vehicle Wax is a long-lasting liquid wax that creates a durable finish that improves a vehicle's appearance and helps keeps dirt from adhering to the surface. It gives added protection against salt, air pollution and acid rain and can be used safely on virtually every surface, including aluminum, stainless steel, glass, plastic, paint and fine automotive paint finishes.



**DETERGENTS**

		Order no.	Size	pH	Color	Scent	Dilution	Foam	Hardness 1-5	Phosphate Free	Kosher Approved /Certified	Description
Vehicle Pre-Soak	8	8.698-221.0	5 gal	12.8	blue	citrus	1:60	high	4	■	■	Vehicle Pre-Soak is used to remove stubborn soils like bugs, tar, oil and grease deposits on vehicles. It's applied before washing in order to penetrate and breakup soils and washed away when the rest of the vehicle washing is done. The more time you allow to soak, the less scrubbing is required. Vehicle Pre-Soak is safe to use on fine auto finishes and strong enough to work on transportation fleet vehicles.
	9	8.698-222.0	55 gal	12.8	blue	citrus	1:60	high	4	■	■	Vehicle Pre-Soak is used to remove stubborn soils like bugs, tar, oil and grease deposits on vehicles. It's applied before washing in order to penetrate and breakup soils and washed away when the rest of the vehicle washing is done. The more time you allow to soak, the less scrubbing is required. Vehicle Pre-Soak is safe to use on fine auto finishes and strong enough to work on transportation fleet vehicles.
Vehicle Tire and Rim Cleaner	10	8.698-225.0	12 x 1 qt	12.9	clear	detergent	RTU	high	3	■	■	Vehicle Tire and Rim Cleaner is a fast and easy way to deep clean the black rubber, road film and brake dust soils from your tires and rims. Simply spray, wait and rinse. This product should be used to clean tire and wheels before adding tire dressing. Make tire dressings look better and last longer. Safe to use on all tires. Safe for steel and aluminum wheels, including coated wheels.
<p><b>Fleet: These products are designed specifically for use on semi trucks, trailers, construction and farm equipment, most commercial transpiration vehicles. Not designed to be used on automobiles.</b></p>												
Fleet Wash Detergent	11	9.803-724.0	5 gal	12.9	green	fresh	1:150	high	5	■	■	Fleet Wash Detergent is a mild detergent designed for exterior cleaning of trucks, busses, equipment and implements.
	12	9.803-754.0	55 gal	12.9	green	fresh	1:150	high	5	■	■	This special emulsifying formula contains high-powered cleaning agents that are effective on grease, road film and smoke trails. It is excellent as a pre-spray for cleaning engines, whitewall tires and vinyl and metal tops. Fleet Wash Detergent is phosphate-free and outperforms most competitive phosphate products. It is safe to use through a pressure washer. Fleet Wash Detergent can be used on polished aluminum, stainless steel, glass, plastic, and painted surfaces.
Heavy Equipment Detergent	13	8.698-150.0	5 gal	12.9	green	fresh	1:150	high	5	■	■	Heavy Equipment Detergent is an effective, safe detergent that can be used on any surface.
	14	8.698-151.0	55 gal	12.9	green	fresh	1:150	high	5	■	■	It is excellent as a pre-spray for softening and breaking up dried on or baked on soils like mud, bugs, greasy film, diesel fuel, lubricants. Excellent foaming capability. It is safe to use through a pressure washer and can be used on polished aluminum, stainless steel, glass, plastic, paint. Heavy Equipment Detergent is phosphate-free and outperforms most competitive phosphate products.

		Order no.	Size	pH	Color	Scent	Dilution	Foam	Hardness 1-5	Phosphate Free	Kosher Approved /Certified	Description
Fleet Wash Solvent Detergent	15	9.803-740.0	5 gal	9.5	light yellow	citrus	1:50	medium	1	■	■	Fleet Wash Solvent Detergent adds the cleaning properties of solvents to boost cleaning capability in order to remove heavy, petroleum-based soils. Citrus-based solvent helps break down these tough soils for fast, efficient removal, saving time and energy. It has the ability to penetrate and break down baked-on hydrocarbon-based soils, like exhaust trails and carbonized grease, yet is safe on most surfaces.
	16	9.803-741.0	55 gal	9.5	light yellow	citrus	1:50	medium	1	■	■	
Fleet Aluminum Brightener	17	9.803-746.0	5 gal	<1	colorless to light straw	sharp	1:5 1:20	low	2	■		Fleet Aluminum Brightener is an extra-strength, acid-based, aluminum cleaner and brightener designed for non-polished aluminum tanks and trailers, aluminum wheels and for preparing aluminum for painting. Do NOT use on glass, polished aluminum or anodized aluminum. Fleet Aluminum Brightener is effective in removing grease, oils, baked-on carbon and diesel smoke. This formula is non foaming.
	18	9.803-747.0	55 gal	<1	colorless to light straw	sharp	1:5 1:20	low	2	■		
Fleet Trailer Cleaner	19	9.803-748.0	5 gal	1.1	straw	citrus	RTU	medium	4			Fleet Trailer Cleaner is a concentrated, non-etching, acid-based detergent formulated to quickly penetrate and remove grease, grime, dirt, road film and welding smut from polished aluminum and stainless steel surfaces. It shines aluminum and stainless by removing the oxidation that makes those surfaces dull looking.
	20	9.803-749.0	55 gal	1.1	straw	citrus	RTU	medium	4			
Fleet Degreaser	21	9.803-734.0	5 gal	13.5	red / orange	none	1:128	medium	5	■	■	Fleet Degreaser is a highly concentrated degreaser designed for petroleum based soils like heavy deposits of oil, grease and dirt as well as axle or fifth-wheel grease, hydraulic oils and diesel smoke stains. Fleet Degreaser is formulated to pass through a pressure washer without damaging the high-pressure pump and is, therefore, safe to use through a pressure washer. It is also safe to use on aluminum, stainless steel, glass, plastic, painted surfaces. Fleet Degreaser is phosphate-free and outperforms competitive phosphate formula products.
	22	9.803-739.0	55 gal	13.5	red / orange	none	1:128	medium	5	■	■	

**DETERGENTS**

		Order no.	Size	pH	Color	Scent	Dilution	Foam	Hardness 1-5	Phosphate Free	Kosher Approved /Certified	Description
Fleet Interior Tank Cleaner 	23	9.803-736.0	5 gal	13.7	straw	slight	1:30	medium	4	■	■	Fleet Interior Tank Cleaner is a highly concentrated and effective cleaner for the interior of tanks and vessels. Interior tank cleaning may or may not be accessible for manual brushing/scraping. This powerful formula can cut through many layers of soil with high pressure washing and soaking, eliminating the need to enter the tank. It is extremely effective in removing the most difficult-to-clean oil, grease and hydrocarbon-based deposits. It cuts grease, grime, oil, burnt carbon. Do not use on aluminum, magnesium, galvanized metal or fine painted surfaces. It is safe to use through a pressure washer and does not damage the high-pressure pump. This formula is phosphate-free and outperforms most competitive phosphate products. NSF Approved, Nonfood Compounds A2
	24	9.803-779.0	55 gal	13.7	straw	slight	1:30	medium	4	■	■	
Fleet Machine and Heavy Equipment Degreaser	25	8.916-134.0	5 gal	13.3	brown	none	1:50	high	5	■	■	Fleet Machine and Heavy Equipment Degreaser is an extra-strong cleaner that is ideal for cleaning heavy equipment, over-the road vehicles and off road machinery. It is especially effective cleaning exhaust stains, road grime and heavy deposits of dirt and oil. Fleet Machine and Heavy Equipment Degreaser is phosphate-free and outperforms competitive phosphate products. This powerful formula is not recommended for use on fine auto finishes, aluminum, magnesium and galvanized metal.
	26	8.916-140.0	55 gal	13.3	brown	none	1:50	high	5	■	■	
Concrete Remover	27	8.698-139.0	5 gal	2.2	yellow	sharp	1:1	low	3	■		Concrete Remover effectively removes concrete splatters and deposits from construction vehicles, equipment, tools and commercial surfaces. Not intended for use on fine automotive finishes. Always pre-test undiluted product in an inconspicuous area, to determine safety and suitability for the intended use.
	28	8.698-140.0	55 gal	2.2	yellow	sharp	1:1	low	3	■		
Salt and Ice Melt Remover	29	8.698-141.0	5 gal	13.4	dark red	slight detergent	1:100	high	5	■	■	Salt and Ice Melt Remover is a combination detergent that removes heavy soil as well as all types of damaging road salt residue. Salt and Ice Melt Remover's unique chelating action breaks down the crystalline structure of ice melt salt and prevents it from crystallizing back on the surface so it can be easily rinsed away with the rest of the dirt. Effective on fine automotive finishes as well as construction equipment, trucks and fleet vehicles.
	30	8.698-142.0	55 gal	13.4	dark red	slight detergent	1:100	high	5	■	■	

		Order no.	Size	pH	Color	Scent	Dilution	Foam	Hardness 1-5	Phosphate Free	Kosher Approved /Certified	Description
<b>Quick Break Detergents: Products formulated for effective cleaning which separate quickly after washing in order to be accepted into on-site treatment systems.</b>												
Quick Release Detergent	31	9.803-720.0	5 gal	12.8	none	slight detergent	1:100	low	4	■	■	Quick Release Detergent is concentrated heavy duty vehicle wash formulated to quickly and effectively remove dirt, grime, grease and road film from vehicles. It is ideal for vehicle wash facilities where it can be used on tractor-trailers, heavy equipment, RVs, trucks, and autos. Quick Release Detergent is formulated to pass through a pressure washer without damaging the high-pressure pump and has an oil-water quick-release surfactant making it ideally suited for use with water treatment systems.
	32	9.803-750.0	55 gal	12.8	none	slight detergent	1:100	low	4	■	■	
<b>Degreasers: Degreasers are designed to be used on medium to heavy soils that require more aggressive formulation for built up greases and oils.</b>												
Chlorinated Degreaser 	33	9.803-712.0	5 gal	12.3	none	slight chlorine	1:60	high	4	■	■	Chlorinated Degreaser removes fats, oils and greases typically found in food service and food processing establishments. It's chlorinated formula breaks down stubborn protein soils that contribute to bio-film formation. This formula is safe on stainless steel, aluminum and painted surfaces. NSF Approved, Nonfood Compounds A1
	34	9.803-716.0	55 gal	12.3	none	slight chlorine	1:60	high	4	■	■	
Heavy Duty Brown Degreaser	35	8.698-148.0	5 gal	13.3	dark brown	none	1:50	high	5	■	■	Heavy Duty Brown Detergent is for cleaning machinery and equipment to remove heavy daily debris of oil, light grease, sand, mud and road film. This detergent is safe to use on most heavy equipment however, due to its strength to handle heavy soils, it should not be used on aluminum, magnesium or fine paint finishes.
	36	8.698-149.0	55 gal	13.3	dark brown	none	1:50	high	5	■	■	
Hood and Duct Degreaser 	37	8.698-199.0	5 gal	13.7	straw	slight	1:30	medium	4	■	■	Hood and Duct cleaner is specifically designed to remove the dangerous build-up of grease in exhaust hoods of food cooking establishments. Through a hot water pressure washer, fast effective removal restores hood and ducts to a clean, safe result. Even carbonized grease. This cleaner can be used to pressure wash food service grills, fryers, broilers and ovens. Routine cleaning is required in most cities and states and by the insurance industry. NSF Approved, Nonfood Compounds A2
	38	8.698-200.0	55 gal	13.7	straw	slight	1:30	medium	4	■	■	

**DETERGENTS**

		Order no.	Size	pH	Color	Scent	Dilution	Foam	Hardness 1-5	Phosphate Free	Kosher Approved /Certified	Description
<b>Industrial: These are our most aggressive products designed to be used in industrial settings like production factories, mining, heavy construction and machine shops.</b>												
Heavy Duty Degreaser	39	8.698-154.0	5 gal	13.3	red / orange	none	1:128	medium	5	■	■	Heavy Duty Degreaser is an industrial strength degreaser for cleaning heavy oils and greases, carbon, lubricants and hydraulic fluids found in industrial and manufacturing environments. Heavy Duty Degreaser is formulated to pass through a pressure washer without damaging the high-pressure pump or heating coil. It is also safe to use on aluminum, stainless steel, glass, plastic and concrete. Heavy Duty Degrease is phosphate-free and outperforms competitive phosphate formula products.
	40	8.698-155.0	55 gal	13.3	red / orange	none	1:128	medium	5	■	■	
Industrial Grease and Carbon Remover	41	9.803-732.0	5 gal	13.7	blue	none	1:100	high	5	■	■	Industrial Grease and Carbon Remover is heavy-duty degreaser that quickly penetrates and cleans grime, spent oil and grease in a variety of applications, including vehicles, equipment, RVs, drilling rigs, trucks and other structures. This highly-concentrated blend is formulated to wet, penetrate and suspend soil, oils and grease and yet is safe to use indoors or outdoors on virtually every surface, including aluminum, stainless steel, glass, plastic, and painted surfaces.
	42	9.803-772.0	55 gal	13.7	blue	none	1:100	high	5	■	■	
Industrial Oil and Grease Remover	43	8.698-156.0	5 gal	12.3	yellow	citrus	1:150	high	5	■	■	Industrial Oil and Grease remover is designed to work on petroleum based oils and greases typically found in factories like cutting oils, lubricants and metal coatings. This product is designed to quickly break up the oils and suspend them in order to rinse easy and prevent them from re-depositing. The result is an oil/grease free surface. Industrial Oil and Grease Remover is engineered to pass through a pressure washer without damaging the high-pressure pump. It is safe to use on aluminum, stainless steel, concrete, glass, plastic and painted surfaces.
	44	8.698-157.0	55 gal	12.3	yellow	citrus	1:150	high	5	■	■	
Metal Paint and Prep Phosphatizer	45	8.698-197.0	5 gal	3.1	none	detergent solvent	1:32	low	5			Metal Paint and Prep Phosphatizer is a complete and economical phosphatizing agent for the phosphatizing of iron and steel parts prior to painting. Effective in spray, dip and wipe-on applications. Metal Paint and Prep Phosphatizer works well in hard or soft water and rinses completely.
	46	8.698-198.0	55 gal	3.1	none	detergent solvent	1:32	low	5			

		Order no.	Size	pH	Color	Scent	Dilution	Foam	Hardness 1-5	Phosphate Free	Kosher Approved /Certified	Description
<b>Building and Maintenance: Products specifically developed for use in building and tool maintenance. Safe to use on materials like brick, siding, stucco, concrete, tile.</b>												
Building Interior/ Exterior Cleaner	47	8.698-135.0	5 gal	10.2	purple	slight	1:130	low	5	■	■	Building Interior/Exterior Cleaner is safe to use on aluminum, stainless steel, glass, plastic, paint, stone and masonry surfaces. Building Interior/Exterior Cleaner is ideal for power washing around a home or shop, including exterior walls, decks, driveways, and roof. This formula is phosphate-free and outperforms most competitive phosphate products.
	48	8.698-136.0	55 gal	10.2	purple	slight	1:130	low	5	■	■	
Concrete Cleaner	49	9.803-744.0	5 gal	12.3	yellow	citrus	1:150	high	5	■	■	Concrete Cleaner is formulated to clean stone and concrete surfaces. It is effective in removing oil, grease, baked-on carbon, tar and asphalt from unfinished concrete floors, walls and grout. Concrete Cleaner is engineered to pass through a pressure washer without damaging the high-pressure pump. It is safe to use on aluminum, stainless steel, glass, plastic and painted surfaces. This formula is phosphate-free and outperforms most competitive phosphate products.
	50	9.803-784.0	55 gal	12.3	yellow	citrus	1:150	high	5	■	■	
<b>Floor Cleaners: Formulated for general purpose and heavy-duty floor cleaning. For use with floor care equipment (such as scrubbers) only.</b>												
Neutral Floor Cleaner	51	8.698-102.0	4 x 1 gal	7.9	light yellow	solvent	1:128	low	4	■	■	Neutral Floor cleaner is formulated for everyday floor cleaning of resilient tile, hard finished floors, polished stone and polished concrete floors. No-rinse formula is designed to remove soil and leave a streak-free finish. Developed for scrubber machines, this formula is non-foaming, phosphate-free and contains ingredients that protect the machine from scale and contaminants.
	52	8.698-103.0	5 gal	7.9	light yellow	solvent	1:128	low	4	■	■	
	53	8.698-104.0	55 gal	7.9	light yellow	solvent	1:128	low	4	■	■	
Shop Floor Cleaner	54	8.698-105.0	5 gal	13.3	light red, clear	solvent	1:128	low	5	■	■	Shop Floor Cleaner is formulated for heavy-duty cleaning of soils typically found in machine shop environments. Lifts and removes petroleum-based grease and oily soils from all types of finished and unfinished concrete, including painted and epoxy-coated floors. No-rinse formula is designed to remove soil and leave a streak-free finish. Developed for scrubber machines, this formula is non-foaming, phosphate-free and contains ingredients that protect the machine from scale and contaminants.
	55	8.698-106.0	55 gal	13.3	light red, clear	solvent	1:128	low	5	■	■	

**DETERGENTS**



		Order no.	Size	pH	Color	Scent	Dilution	Foam	Hardness 1-5	Phosphate Free	Kosher Approved /Certified	Description
Warehouse Floor Cleaner	56	8.698-107.0	5 gal	12.9	blue	solvent	1:128	medium	5	■	■	Warehouse Floor Cleaner is formulated for everyday warehouse concrete floor cleaning. Use on finished or unfinished concrete. Safe for polished concrete floors. No-rinse formula is designed to remove dense concrete dust and leave a streak-free finish. Developed for scrubber machines, this formula is non-foaming, phosphate-free and contains ingredients that protect the machine from scale and contaminants.
	57	8.698-108.0	55 gal	12.9	blue	solvent	1:128	medium	5	■	■	
	58	8.698-109.0	275 gal	12.9	blue	solvent	1:128	medium	5	■	■	
Ice Breaker Freezer Cleaner	59	8.759-330.0	4 x 1 gal	11.9	clear blue	none	3:1	low	5	■	■	A fast-acting, highly efficient cleaner / degreaser, specially formulated for cleaning frozen food and cold storage areas where conventional products would freeze. Penetrates, dissolves and suspends dirt, grime, fats and grease while freezer equipment is still operating. Safe on cleaning concrete, quarry tile, ceramic and metal surfaces.
	60	8.759-329.0	5 gal	11.9	clear blue	none	3:1	low	5	■	■	
	61	8.759-328.0	55 gal	11.9	clear blue	none	3:1	low	5	■	■	
Tire Mark Remover and Pre-Soak	62	8.759-327.0	1 x 1 qt	12.0-12.8	clear yellow	citrus	RTU	low	5	■	■	Kärcher Tire Mark Remover eliminates stubborn rubber marks quickly and is a ready-to-use, spray and wipe / pre-spray cleaner with synergistic solvent power. This cleaner has been specifically formulated to remove rubber tire marks on floors and other hard surfaces. Kärcher Tire Mark Remover also removes greasy soils and marks on most washable surfaces, including those listed below.
	63	8.759-326.0	4 x 1 gal	12.0-12.8	clear yellow	citrus	RTU	low	5	■	■	
	64	8.759-325.0	55 gal	12.0-12.8	clear yellow	citrus	RTU	low	5	■	■	

**Soft Floor Cleaners: Formulated for general purpose and heavy-duty soft floor cleaning. For use with floor care equipment only.**

**Red Carpet**

Red Carpet Super Pre-Spray	65	8.695-207.0	4 x 1 gal case	10.2	blue green	citrus	1:16	medium	5		■	Pre-spray
Red Carpet Super Conditioning Rinse	66	8.695-209.0	4 x 1 gal case	2.2	green	citrus	1:128	low	5	■		Conditioning rinse
Red Carpet Extraction Cleaner	67	8.695-210.0	4 x 1 gal case	11.5	bright blue	citrus	1:128	low	5	■	■	Extraction cleaner
Red Carpet Wool & Natural Fiber Cleaner	68	8.695-211.0	4 x 1 gal case	8.0	slate blue	citrus	1:128	low	5		■	Wool and natural fiber cleaner
Red Carpet Liquid Defoamer	69	8.695-213.0	4 x 1 gal case	7.0	white	none	1:128	n/a	1		■	Defoamer
Red Carpet Enzyme Deodorizer	70	8.695-218.0	4 x 1 gal case	8.5	amber	citrus	1:4	low	2		■	Enzyme Deodorizer
Red Carpet Odor Neutralizer	71	8.695-219.0	4 x 1 gal case	7.6	clear	floral	1:128	medium	3	■	■	Odor neutralizer
Red Carpet Pro Spotter	72	8.695-222.0	12 x 1 qt case	7.1	clear	none	1:1	medium	5	■	■	Spotter
2-Gallon Pump Sprayer with Wand	73	8.628-441.0	-	-	-	-	-	-	-			Sprayer with wand



		Order no.		Size	pH	Color	Scent	Dilution	Foam	Hardness 1-5	Phosphate Free	Kosher Approved /Certified	Description
<b>iCapsol™ Encapsulating Chemical</b>													
iCapsol™ encapsulating chemical	74	8.695-226.0		4 x 1 gal case	7.2	amber	none	1:16	medium	3	■	■	Low moisture carpet cleaner
	75	8.695-469.0		12 x 1 pt case	7.2	amber	none	1:16	medium	3	■	■	
iCapsol™ encapsulator / protector	76	8.695-227.0		4 x 1 gal case	7.0	amber	none	1:16	medium	3	■	■	Low moisture carpet cleaner
	77	8.695-643.0		5 gal	7.0	amber	none	1:16	medium	3	■	■	
	78	8.695-470.0		12 x 1 pt case	7.0	amber	none	1:16	medium	3	■	■	
<b>Miscellaneous</b>													
Vital Oxide (US Only)  	79	8.759-565.0		12 x 3 oz case	8.0	clear	none	RTU 1:5 1:9	medium	3	■	■	Vital Oxide is a hospital grade disinfectant sanitizer with 9 key attributes. Disinfection, Sanitizing, Odor Elimination, Carpet Sanitization, Allergen Removal, Kills Mold and Mildew, Kills biofilm, Parvo, Distemper, Tuberculous, SARS-CoV-2 (the cause of COVID-19). Sanitizer dilution is NSF approved as a no rinse sanitizer for non porous food contact surfaces. (US Only)
	80	8.639-558.0		4 x 1 gal pack	8.0	clear	none	RTU 1:5 1:9	medium	2	■	■	
	81	8.639-560.0		6 x 1 qt	8.0	clear	none	RTU 1:5 1:9	medium	2	■	■	
	82	8.644-292.0		5 gal	8.0	clear	none	RTU 1:5 1:9	medium	2	■	■	
	83	8.642-823.0		15 gal	8.0	clear	none	RTU 1:5 1:9	medium	2	■	■	
	84	8.698-112.0		55 gal	8.0	clear	none	RTU 1:5 1:9	medium	2	■	■	
Vital Oxide, Secondary Label 3" x 3" (US Only)	85	8.644-439.0		Pack of 25	-	-	-	RTU	-	-	■	■	
Vital Oxide, Secondary Label 3" x 3" (US Only)	86	8.642-868.0		Pack of 25	-	-	-	1:5	-	-	■	■	
Vital Oxide, Secondary Label 3" x 3" (US Only)	87	8.642-869.0		Pack of 25	-	-	-	1:9	-	-	■	■	
Professional Multi-Purpose & Daily Cleaner	88	8.759-332.0		12 x 1 qt	10.8	none	none	RTU	low	3	■	■	Kärcher Professional Multi-Purpose & Daily Cleaner quickly cuts through grease, grime and dirt. This highly versatile product can be used on a wide range of surface types including tile, plastics, laminate, and stainless steel. It is powerful yet gentle enough for use as a daily cleaner.  Kärcher Professional Multi-Purpose Cleaner is also designed to be used to clean and prepare hard surfaces prior to a disinfection step. It is the first step of an EPA-recommended two-step process for complete cleaning and disinfecting.
	89	8.759-331.0		4 x 1 gal	10.8	none	none	RTU	low	3	■	■	
Gum Remover Detergents	90	8.641-480.0		20 x 90 ml	6.0	amber	none	RTU	medium	2	■	■	SG3 Bp chemical bottle

**DETERGENTS**

		Order no.	Size	pH	Color	Scent	Dilution	Foam	Hardness 1-5	Phosphate Free	Kosher Approved /Certified	Description
RM 99 Solar Cleaner	91	8.698-094.0	5 gal	8.8	none	none	1:100 1:200	low	4	■		RM 99 Solar Cleaner is specific for cleaning solar and photovoltaic systems, and it's perfectly adapted to their unique surfaces. Its highly efficient, gentle on materials, biodegradable and removes even stubborn and greasy stains. It prevents the formation of limescale and maximizes the effectiveness of the system at minimum cost.
Compass™ Clean	92	8.695-241.0	4 x 1 gal case	13.6	orange	none	RTU	medium	3	■		Food service cleaner / degreaser
Compass™ Shine	93	8.695-242.0	4 x 1 gal case	1.0	dark green	winter green	RTU	medium	5			Concentrated bathroom cleaner / deodorizer
Compass™ Rinse	94	8.695-243.0	12 x 1 qt case	3.9	clear	none	1:2560	low	5	■		Spot free drying agent
<b>Detergent for Pressure Washer Maintenance</b>												
Coil Descaler	95	9.803-742.0	12 x 2 lb	1.0	white	slight solvent	1:16	high	5	■		Coil descaler quickly and safely removes hard water scale build up that robs the performance of your pressure washer. Removing the build-up improves the water flow, heat transfer while reducing strain on the pump.
Pump and Coil Protectant	96	8.698-058.0	12 x 1 qt	7.3	amber	none	RTU	none	5	■		Pump and Coil Protectant is a multi-component product made from heat-resistant organic and inorganic salts. Its stabilizing action on the minerals which cause hardness in water, is based on its ability to impede the growth of mineral deposits. This product is proprietary to machines that have a built in dispenser for this product. Keeps your machine running efficiently with optimum performance and reliability.
	97	9.556-111.0	4 x 1 gal	7.3	amber	none	RTU	none	5	■		
	98	9.556-011.0	5 gal	7.3	amber	none	RTU	none	5	■		
Pump and Coil Protectant Concentrate	99	9.556-010.0	5 gal	7.6	light brown	none	5 gal makes 55 gals	none	5	■		
<b>Gum Remover Supplies for SG1</b>												
Gum Remover Solution	100	8.638-580.0	24 liters	-	-	-	1:1	-	-	-	-	
Service Pack for SG1	101	8.639-871.0	-	-	-	-	1:1	-	-	-	-	Contains 2 LPG, 4 Bottles of Solution, 2 Black SS Brushes, 1 Green Brush
Gas Bottles	102	8.638-579.0	12 pack	-	-	-	1:1	-	-	-	-	
<b>Additional Detergent Accessories</b>												
pH Test Strips	103	8.753-577.0	100 pack	-	-	-	-	-	-	-	-	Contains 100 universal pH test strips
White 5 gallon pail with lid	104	9.846-058.0	5 gal	-	white	-	-	-	-	-	-	White 5 gallon pail and lid. UN rated
Blank Secondary Label	105	8.642-712.0	-	-	-	-	-	-	-	-	-	Secondary write in chemical / detergent label

## EASY!FORCE TRIGGER GUN – ZERO EFFORT REQUIRED!

Introducing the most effortless trigger gun on the market, the new Kärcher EASY!Force. The revolutionary EASY!Force trigger gun uses its own recoil force to hold the trigger down for you. This means no more sore hands after hours of use. Try our EASY!Force trigger gun – it is so much fun, you will not want to put it down!



**Ergonomics.** Our EASY!Force technology holds the trigger down once you start it, avoiding the strain on your hands associated with other trigger guns.

**Faster set-up.** The new EASY!Lock connection system allows set-ups that are five times faster than existing systems. A simple 360° turn provides a fully-threaded, secure connection.

**Designed for long life.** Our EASY!Force valve consists of a ceramic ball with ceramic sealing seat that is resistant to any particles liable to cause potential damage. This gives it a lifetime five times longer than trigger guns with conventional valve.



**Two versions.** Introducing the North American EASY!Force trigger gun with standard threads for our North American engineered pressure washers and accessories, and our EASY!Force trigger gun with EASY!Lock threading for our German engineered machines and EASY!Lock accessory system.

- **EASY!Force - North American Model.** Standard 1/4" connection for wand and 3/8" connection for hose. (NOT for use with EASY!Lock accessories) P/N 8.756-481.0 (see page 112)
- **EASY!Force - German Model.** The EASY!Lock Threading for EASY!Lock adapters and accessories. (Adapters not included) P/N 4.118-005.0

**Built in safety.** The trigger gun features a mechanical safety to prevent accidental starts for maximum safety without compromising its ease-of-use.

**Perfect connections.** The same quick locking, screw connection of EASY!Lock can be used on existing pressure washers and accessories. An easy system of adapters ensures compatibility is easy, and allows you to experience the power of the EASY!Force trigger gun. Contact your local dealer to find out more. Try our EASY!Force trigger gun – you won't want to put it down.

# WHAT PERFECT CONNECTIONS LOOK LIKE

In order to cover the various interfaces, from the pressure washer to the nozzle, as well as ensuring compatibility is easy, a total of 10 different adapters are available. This ensures that all existing machines and accessories can continue to be used together with the new machines and accessories with EASY!Lock connections. Listed to the right are all adapters with their respective application.\*

Our EASY!Lock system  
The below illustration demonstrates the features of adapters 1-8. These adapters are for use with machines having metric connections. Adapters 9 and 10 are for use with 3/8" connections.

## EMBOSED NUMBER

Every adapter has its own number. Clear and unmistakable.

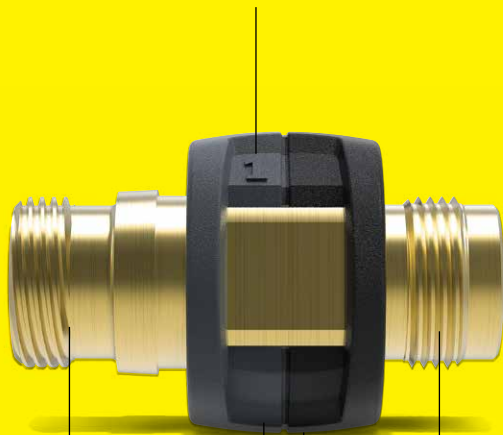

**EASY!Lock connection**  
Quadruple trapezoidal thread with conical lock

**Metric Thread**  
Metric thread for accessories without EASY!Lock

**Anthracite gray = EASY!Lock**  
Color coding for EASY!Lock connection

**Black = Metric Thread**  
Color coding for conventional threaded connection

1



2



3



4



5



6



7



8



9



10



\*For example, any pressure washer with M22 x 1.5 connection can quickly be converted to the new EASY!Lock system with adapter 2.

**EASY!Lock - M 22 x 1.5****Order no. 4.111-029.0**

Adapter for connecting high-pressure hoses with EASY!Lock and high-pressure hoses with M 22 x 1.5 connection.

**EASY!Lock - M 22 x 1.5****Order no. 4.111-030.0**

Adapter for connecting high-pressure hoses with EASY!Lock and pressure washers / trigger guns with M 22 x 1.5 connection.

**EASY!Lock - M 22 x 1.5****Order no. 4.111-031.0**

Adapter for connecting spray lances or Servo Control regulators with EASY!Lock and trigger guns with M 22 x 1.5.

**EASY!Lock - AVS****Order no. 4.111-032.0**

Adapter for connecting EASY!Force trigger gun and high-pressure hoses with AVS swivel connection.

**EASY!Lock - M 22 x 1.5****Order no. 4.111-033.0**

Adapter for connecting EASY!Force trigger gun and spray lances with M 22 x 1.5 connection.

**EASY!Lock - M 22 x 1.5****Order no. 4.111-034.0**

Adapter for connecting EASY!Force trigger gun / pressure washers with EASY!Lock and high-pressure hoses with M 22 x 1.5 connection.

**EASY!Lock - M 18 x 1.5****Order no. 4.111-035.0**

Adapter for connecting nozzles with EASY!Lock and spray lances with M 18 x 1.5 connection.

**EASY!Lock - M 18 x 1.5****Order no. 4.111-036.0**

Adapter for connecting spray lances with EASY!Lock and nozzles with M 18 x 1.5 connection.

**EASY!Lock - STANDARD 3/8" HOSE****Order no. 4.111-041.0**

Adapter for connecting EASY!Force trigger gun and standard 3/8" US-style hose connection.

**EASY!Lock - STANDARD 3/8" MACHINE OUTLET****Order no. 4.111-042.0**

Adapter for connecting high-pressure hoses with EASY!Lock and 3/8" US-style machine outlet.

**ADDITIONAL EASY!LOCK ADAPTERS ON PAGE 101**

# EASY!FORCE TRIGGER GUN AND EASY!LOCK ACCESSORY SYSTEM



■ NOTE: Accessories only compatible with EASY!Force Trigger Gun for EASY!Lock Threading. (Part # 4.118-005.0, shown above in Box 1)

		Order no.	Description
<b>EASY!Force Trigger Gun</b>			
EASY!Force trigger gun for EASY!Lock threading	1	4.118-005.0 ■	Trigger gun uses the recoil force of the high-pressure spray to reduce the hold force of the trigger to zero.
EASY!Force trigger gun repair kit	2	4.427-014.0 ■	EASY!Force trigger gun repair kit: manifold complete with full ceramic valve (for gun 4.118-005.0)
	3	2.885-483.0 ■	EASY!Force trigger gun repair kit: spare part lever kit (for guns 8.756-481.0 and 4.118-005.0)
Lance	4	4.112-000.0 ■	41" spray lance
Lance repair kit	5	2.880-001.0 ■	EASY!Force lance repair kit: quad-ring sealing (3)
Side handle	6	4.321-380.0 ■	Ergonomic handle that attaches to the spray lance and offers additional working positions.
Power nozzle Spray angle 25°	7	2.113-004.0 ■	Patented Kärcher power nozzle technology offers 40% increase in cleaning performance over conventional nozzles. Engineered for EASY!Lock. Size: 035
	8	2.113-023.0 ■	Patented Kärcher power nozzle technology offers 40% increase in cleaning performance over conventional nozzles. Engineered for EASY!Lock. Size: 050
	9	2.113-014.0 ■	Patented Kärcher power nozzle technology offers 40% increase in cleaning performance over conventional nozzles. Engineered for EASY!Lock. Size: 075
	10	2.113-017.0 ■	Patented Kärcher power nozzle technology offers 40% increase in cleaning performance over conventional nozzles. Engineered for EASY!Lock. Size: 100
Servo control	11	4.118-007.0 ■	Pressure and water flow regulation directly at the EASY!Force trigger gun. For 0-3.3 GPM.
	12	4.118-008.0 ■	Pressure and water flow regulation directly at the EASY!Force trigger gun. For 3.3-4.9 GPM.
	13	4.118-009.0 ■	Pressure and water flow regulation directly at the EASY!Force trigger gun. For 4.9 GPM.
<b>Standard EASY!Lock Hose</b>			
EASY!Lock hose	14	6.110-034.0 ■	33' EASY!Lock hose, 3625 PSI
	15	6.110-031.0 ■	33' EASY!Lock hose
	16	6.110-033.0 ■	50' EASY!Lock hose
	17	6.110-030.0 ■	50' EASY!Lock hose with ANTI!Twist connection
	18	6.110-014.0 ■	100' EASY!Lock hose with ANTI!Twist connection
<b>Longlife EASY!Lock Hose</b>			
Longlife EASY!lock hose - designed with two steel layers instead of one, for no leaks! 5800 PSI	19	6.110-029.0 ■	50' EASY!Lock Longlife hose with ANTI!Twist connection
	20	6.110-023.0 ■	100' EASY!Lock Longlife hose with ANTI!Twist connection
	21	6.110-028.0 ■	66' EASY!Lock Longlife hose with one side AVS hose reel connection
<b>Food Grade EASY!Lock Hose</b>			
Food grade EASY!Lock hose	22	6.110-051.0 ■	33' EASY!Lock Food grade hose with ANTI!Twist connection
	23	6.110-052.0 ■	66' EASY!Lock Food grade hose with ANTI!Twist connection
	24	6.110-063.0 ■	50' EASY!Lock Food grade hose with AVS hose reel connection

■ Designates EASY!Lock Connection

# EASY!FORCE TRIGGER GUN AND EASY!LOCK ACCESSORY SYSTEM



■ NOTE: Accessories only compatible with EASY!Force Trigger Gun for EASY!Lock Threading.  
(Part # 4.118-005.0, shown on previous page, in Box 1)

		Order no.	Description
<b>Adapter for EASY!Lock System</b>			
Adapter	1	4.111-029.0 ■	EASY!Lock - M 22 x 1.5. Adapter for connecting high-pressure hoses with EASY!Lock and high-pressure hoses with M 22 x 1.5 connection.
	2	4.111-030.0 ■	EASY!Lock - M 22 x 1.5. Adapter for connecting high-pressure hoses with EASY!Lock and pressure washers / trigger guns with M 22 x 1.5 connection.
	3	4.111-031.0 ■	EASY!Lock - M 22 x 1.5. Adapter for connecting spray lances or Servo Control regulators with EASY!Lock and trigger guns with M 22 x 1.5.
	4	4.111-032.0 ■	EASY!Lock - AVS. Adapter for connecting EASY!Force trigger gun and high-pressure hoses with AVS swivel connection.
	5	4.111-033.0 ■	EASY!Lock - M 22 x 1.5. Adapter for connecting EASY!Force trigger gun and spray lances with M 22 x 1.5 connection.
	6	4.111-034.0 ■	EASY!Lock - M 22 x 1.5. Adapter for connecting EASY!Force trigger gun / pressure washers with EASY!Lock and high-pressure hoses with M 22 x 1.5 connection.
	7	4.111-035.0 ■	EASY!Lock - M 18 x 1.5. Adapter for connecting nozzles with EASY!Lock and spray lances with M 18 x 1.5 connection.
	8	4.111-036.0 ■	EASY!Lock - M 18 x 1.5. Adapter for connecting spray lances with EASY!Lock and nozzles with M 18 x 1.5 connection.
	9	4.111-037.0 ■	EASY!Lock - EASY!Lock to connect 2 EASY!Lock hoses
	10	4.111-041.0 ■	EASY!Lock - STANDARD 3/8" HOSE. Adapter for connecting EASY!Force trigger gun with standard 3/8" US-style hose connection.
	11	4.111-042.0 ■	EASY!Lock - STANDARD 3/8" MACHINE OUTLET. Adapter for connecting high-pressure hoses with EASY!Lock and 3/8" US-style machine outlet.
	12	4.111-055.0 ■	Adapter complete TR22IG-3/8 NPT. Adapter to connect EASY!Force Trigger Gun to 3/8" FPT. This can be used to connect 3/8" FPT Inlet Injector.
	13	4.111-056.0 ■	Adapter complete TR22AG-3/8 NPT. Adapter to connect EASY!Lock Hose to 3/8" MPT. This can be used to connect 3/8" MPT Injector.
	14	4.111-057.0 ■	Adapter complete 17 TR20IG-1/4 NPT. Adapter to connect EASY!Force Lance to 1/4" FPT. This can be used to attached a standard Quick Coupler or Turbo Nozzle.
	15	4.111-058.0 ■	Adapter complete 18 TR20AG-1/4 NPT. Adapter to connect standard North American Lance with 1/4" MPT to FRV 30.
	16	4.111-059.0 ■	Adapter complete 19 TR22AG-1/4 NPT. Adapter to connect standard North American Trigger Gun with 1/4" FPT to EASY!Lock Pivoting Wand or EASY!Lock Inno Foam Lance.
	17	4.111-060.0 ■	Adapter complete 20 TR22IG-1/4 NPT. Rotating Adapter to be able to connect EASY!Force Gun to standard 1/4" MPT thread lance. This can be used to connect a standard VP Wand.

■ Designates EASY!Lock Connection



# ISOLAR 400/800 SOLAR PANEL CLEANER



## No place is unreachable.

The iSolar accessories system is a complete modular solution that offers all the necessary products for your cleaning needs, from water connections to brushes. This system is also compatible with many Kärcher pressure washers, meaning, existing pressure washers can usually be used to operate iSolar. Because the system is modular, we can build a custom solution to fulfill any requirement.

The iSolar 400 and iSolar 800 offer superior and safe cleaning, thanks to brushes powered by a pressure washer's water jet. The mechanical action of the bristles, made of nylon for scratch-free surface cleaning, operate at low pressure, eliminating any danger of the panels being damaged. The rotating brushes are also fitted with robust ball bearings to guarantee exceptionally long service life.



### 1 iSolar 800

Counter-rotating disc brushes ensure:

- Excellent cleaning performance and area coverage
- Optimal handling with balancing of transverse forces
- Pre-rinsing of adjacent panels

### 2 Comfortable in every position

Stable articulated joint offers:

- Convenient and flexible working positions
- Robust brass design for maximum durability

### 3 iSolar 400

Entry-level model for smaller areas:

- Particularly suitable for elevated systems
- Pre-rinsing of adjacent panels

### 4 Safety first

For safe rooftop work:

- Safety harness with quick-release fasteners
- Guided fall arrestor with integrated shock absorber and lengthy guide rope

# ISOLAR 400/800 SOLAR PANEL CLEANER

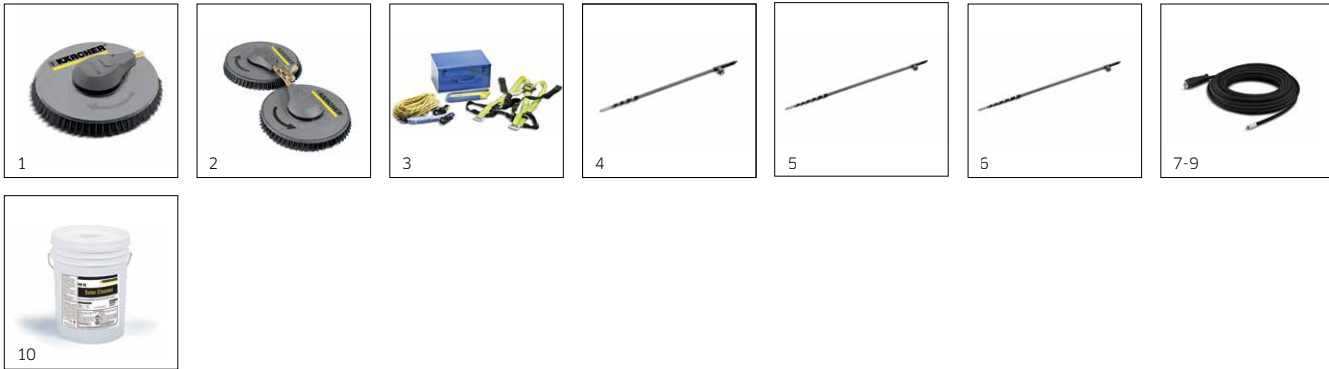

		Order no.	Length	Flow rate	Max. feed temperature	Description
<b>iSolar panel cleaner</b>						
iSolar 400	1	6.368-093.0		4.4-5.7 GPM	104°F	The water-driven iSolar 400 disc brush features a working width of 400 mm and is especially suitable for cleaning small to medium-sized photo-voltaic systems. Thanks to the low weight and easy handling, even elevated systems can be conveniently cleaned.
		6.368-092.0		3.4-4 GPM		
iSolar 800	2	6.368-095.0		4.4-5.7 GPM	104°F	The water-driven iSolar 800 brush head with 800 mm working width works with two contra-rotating disc brushes and is used for cleaning photo-voltaic systems. The contra-rotating brushes balance out all transversal forces, guaranteeing optimal handling. The flexible angle joint on the brush head's connector also makes cleaning easier. It ensures that the bristles always lie flat, allowing uniform cleaning results. The brush head features especially high area performance - ideal for cleaning large systems, for example on barn roofs.
		6.368-094.0		3.4-4 GPM	104°F	
Safety kit	3	6.988-152.0				Certified, standard-compliant safety system for safe working on roofs. The fall protection includes a traveling fall arrestor with shock absorber and 49.2 ft kernmantle rope, safety harness, an anchoring loop for fixing the safety machine, as well as a practical metal box for storage and transport.
iSolar TL 7 H (without hose, iSolar HP hose 7 required)	4	4.762-610.0	5-23 ft.		140°F	Telescopic wand made from carbon/fiberglass mixture for maximum rigidity with minimum weight. With a 23.6 ft maximum reach and practical quick-release couplings for easy extension and retraction.
iSolar TL 10 C (without hose, iSolar HP hose 10 required)	5	4.762-612.0	7-33 ft.		140°F	The telescopic wand is made from a carbon-fiberglass mixture (hybrid) and offers maximum rigidity with minimum weight. It has a reach of up to 32.8 ft and is fitted with practical quick-release couplings - for convenient extension and retraction. The speed is regulated via ball tap, guaranteeing easy handling. The carbon-fiberglass mixture is also on the lowest rod element and ensures electrical insulation and thus work safety.
iSolar TL 14 C (without hose, iSolar HP hose 14 required)	6	4.762-613.0	7-45 ft.		140°F	The telescopic wand is made from a carbon-fiberglass mixture (hybrid) and offers maximum rigidity with minimum weight. It has a reach of up to 45.9 ft and is fitted with practical quick-release couplings - for convenient extension and retraction. The speed is regulated via ball tap, guaranteeing easy handling. The carbon-fiberglass mixture is also on the lowest rod element and ensures electrical insulation and thus work safety.
iSolar HP hose 7	7	6.392-978.0	28 ft.		311°F	The high-quality and flexible high-pressure hose with rubber outer covering is suitable for use in combination with the iSolar TL 7. The outer skin of the hose features especially good sliding properties - ideal for extending and retracting the telescopic wand.
iSolar HP hose 10	8	6.392-977.0	38 ft.		311°F	The high-quality and flexible high-pressure hose with rubber outer covering is suitable for use in combination with the iSolar TL 10. The outer skin of the hose features especially good sliding properties - ideal for extending and retracting the telescopic wand.
iSolar HP hose 14	9	6.392-976.0	49 ft.		311°F	The high-quality and flexible high-pressure hose with rubber outer covering is suitable for use in combination with the iSolar TL 14. The outer skin of the hose features especially good sliding properties - ideal for extending and retracting the telescopic wand.
RM 99 solar cleaner	10	8.698-094.0				RM 99 Solar Cleaner is specific for cleaning solar and photovoltaic systems, and it's perfectly adapted to their unique surfaces. Its highly efficient, gentle on materials, biodegradable and removes even stubborn and greasy stains. It prevents the formation of limescale and maximizes the effectiveness of the system at minimum cost.

# HIGH-PRESSURE HOSES



Kärcher's original equipment hoses are the preferred choice of experienced pressure washer operators. Constructed of the highest-quality materials available, our anti-kink hoses deliver outstanding durability and improved operator convenience. Kärcher hoses are more flexible and easier to wind than competitors' hoses and are more convenient to use thanks to easy-grip hose-ends which can be tightened without tools.

		Order no.	Max Temp	Max working pressure (PSI)	Length (ft.)	Description
<b>Integral AVS connection - passive swivel</b>						
High-pressure hose, 33', ID 6, AVS trigger gun connector	1	6.391-238.0	311°F	3625	33	With patented AVS trigger gun connector (rotatable) and coupling, M 22 x 1.5 with anti-kink sleeve.
High-pressure hose, 50', ID 6, AVS trigger gun connector	2	6.390-174.0	311°F	3625	50 (20 m)	
<b>Integral AVS connection</b>						
High-pressure hose, 33', ID 6	3	6.389-853.0	311°F	3625	33	Integral AVS connection
High-pressure hose, 33', ID 8	4	6.390-025.0	311°F	4565	33	
High-pressure hose, 50', ID 8	5	6.390-185.0	311°F	4565	50	
<b>Female twist-type connection (22 mm)</b>						
High-pressure hose, 33', ID 8, extension piece	6	6.391-342.0	311°F	4565	33	Female twist-type connection (22 mm)
High-pressure hose, 50', ID 8	7	6.390-010.0	311°F	4565	50	
High-pressure hose, 100', ID 8	8	6.390-293.0	311°F	4565	100	
High-pressure hose, 50', ID 10	9	6.390-023.0	311°F	3190	50	
<b>Extension hose 2 x 22 mm (no swivel)</b>						
High-pressure hose, 50', ID 8  (requires 4.403-002.0 brass extension coupling to connect to other hose)	10	9.162-323.0	185°F	4000	50	Extension hose 2 x 22 mm (no swivel)
High-pressure hose, 100', ID 8  (requires 4.403-002.0 brass extension coupling to connect to other hose)	11	9.162-305.0	311°F	3600	100	
<b>Premium long-life 400 hose (Integral AVS connection)</b>						
Integral AVS connection, 66', ID 8	12	6.390-208.0	311°F	5800	66	Kärcher's premium Long-life 400 hoses, identified with a yellow stripe, are the best of the best and are available to fit AVS or 22 mm twist-type connections. This hose has an integral pivot end to fit AVS trigger guns and a 22 mm female threaded end with anti-kink protection.
<b>Premium long-life 400 hose (22 mm twist-type connection)</b>						
22 mm twist-type connection, 33', ID 8	13	6.388-083.0	311°F	5800	33	The Long-life twist-type hose has two 22 mm female anti-kink threaded ends for non-AVS trigger guns. The yellow end indicates full 360° swivel capability at that point—even under full pressure.
22 mm twist-type connection, 50', ID 8	14	6.389-709.0	311°F	5800	50	
22 mm twist-type connection, 66', ID 8	15	6.390-027.0	311 °F	5800	66	
22 mm twist-type connection, 100', ID 8	16	6.390-294.0	311°F	5800	100	
<b>Food-grade hoses</b>						
High-pressure hose, 50', ID 6, AVS trigger gun connector 11 mm, suitable for food industry, gray	17	6.391-654.0	311°F	3625	50	With patented AVS trigger gun connector (rotatable) and coupling, M 22 x 1.5 with anti-kink sleeve. With gray non-marking outer cover.
High-pressure hose, 50', ID 6, AVS gun connection, 15 mm, suitable for food	18	6.390-445.0	311°F	3625	50	

# HIGH-PRESSURE HOSES



	Order no.	Max Temp	Max working pressure (PSI)	Length (ft.)	Description	
<b>Food industry version with unions on both sides</b>						
High-pressure hose, 33', ID 8, suitable for the food industry, extension piece	19	6.389-479.0	311°F	3625	33	Connectors at both ends, M 22 x 1.5, with kink protection.
High-pressure hose, 66', ID 8, suitable for food industry, extension piece	20	6.389-581.0	311°F	3625	66	With gray non-marking outer cover.
<b>Special hose</b>						
High-pressure hose 66', ID 20, including connectors, outlet bend	21	6.391-886.0	311°F	5800	66	High pressure hose for connection to hose reel.
<b>Standard EASY!Lock Hose</b>						
EASY!Lock hose	22	6.110-034.0	311°F	3625	33	EASY!Lock hose
	23	6.110-031.0	311°F	4565	33	EASY!Lock hose
	24	6.110-033.0	311°F	4565	50	EASY!Lock hose
	25	6.110-030.0	311°F	4565	50	EASY!Lock hose with ANTI!Twist connection
	26	6.110-014.0	311°F	4565	100	EASY!Lock hose with ANTI!Twist connection
<b>Longlife EASY!Lock Hose</b>						
Longlife EASY!lock hose - designed with two steel layers instead of one, for no leaks!	27	6.110-029.0	311°F	5800	50	EASY!Lock Longlife hose with ANTI!Twist connection
	28	6.110-027.0	311°F	5800	66	EASY!Lock long life hose with ANTI!Twist connector
	29	6.110-023.0	311°F	5800	100	EASY!Lock Longlife hose with ANTI!Twist connection
	30	6.110-028.0	311°F	5800	66	EASY!Lock Longlife hose with one side AVS hose reel connection
<b>Food Grade EASY!Lock Hose</b>						
	31	6.110-063.0	311°F	3625	50	EASY!Lock Food grade hose with AVS hose reel connection

# KÄRCHER R1 AND R2 HOSE

Introducing the new Kärcher R1 and R2 hose. The R1 and R2 hose is built to exceed the EN1829-2 Standard and will provide superior abrasion resistance that will increase the life of the hose. The R1 and R2 hose is rated up to 250°F and is available in 4000, 5000 and 6000 PSI.

Both single- and double-wire braid hoses come with durable bend restrictors on both ends, with a 24-inch bend restrictor on the gun end for added operator protection against high-pressure bursts.

The R1 and R2 hose has a “bite-the-wire” coupling that grips the hose better than any other design.



- Temperature Rating: R1 and R2 hose are rated for continuous temperatures up to 250°F.
- Certified Burst Protection: R1 and R2 hose meets the stringent UL-1776 safety standards with two hose guards—including a 24-inch sleeve on the gun end—for added operator protection against bursts.
- Easily Identified: Permanently embossed identification makes for easy tracing and owner protection.
- Unique Coupling: A “bite-the-wire” coupling actually reaches the wire braid for never-slip retention, far superior to the “compression” fittings used on conventional hoses.



		Order no.	Max Temp	Max working pressure (PSI)	Size	Length (ft.)	Description
<b>Kärcher R1, 1-wire</b>							
3/8" MPT Swivel x 3/8" MPT Solid	1	8.925-148.0	250°F	4000	3/8"	25	Kärcher branded bend black restrictor
	2	8.925-154.0	250°F	4000	3/8"	50	Wrapped impression, maximum
	3	8.925-159.0	250°F	4000	3/8"	75	Oil resistant tube and cover with black hose guard, both ends. Rated to 250°F
	4	8.925-163.0	250°F	4000	3/8"	100	
	5	8.925-168.0	250°F	4000	3/8"	150	
	6	8.925-377.0	250°F	4000	3/8"	50	Case, Qty 75 (8.925-154.0), 3/8" 50' 1W
	7	8.925-447.0	250°F	4000	3/8"	100	Case, Qty 40 (8.925-163.0), 3/8" 100' 1W
<b>Kärcher R1, 1-wire</b>							
3/8" MPT Swivel x 3/8" MPT Swivel	8	8.925-359.0	250°F	4000	3/8"	50	Kärcher branded bend black restrictor
	9	8.925-361.0	250°F	4000	3/8"	100	Wrapped impression, maximum Oil resistant tube and cover with black hose guard, both ends. Rated to 250°F
<b>Kärcher R2, 2-wire</b>							
3/8" MPT Swivel x 3/8" MPT Solid	10	8.925-178.0	250°F	6000	3/8"	25	Kärcher branded bend red restrictor
	11	8.925-182.0	250°F	6000	3/8"	50	Wrapped impression, maximum
	12	8.925-186.0	250°F	6000	3/8"	75	Oil resistant tube and cover with yellow hose guard, both ends. Rated to 250°F
	13	8.925-227.0	250°F	6000	3/8"	100	
	14	8.925-381.0	250°F	6000	3/8"	50	Case, Qty 75 (8.925-182.0), 3/8" 50' 2W
15	8.925-448.0	250°F	6000	3/8"	100	Case, Qty 40 (8.925-227.0), 3/8" 100' 2W	
<b>Kärcher R2, 2-wire</b>							
3/8" MPT Swivel x 3/8" MPT Solid	13	8.925-245.0	250°F	5000	1/2"	50	Kärcher branded bend red restrictor. Wrapped impression, maximum oil resistant tube and cover. 2-wire protection. Includes 1-3/8" FPT Coupler Socket.
	14	8.925-246.0	250°F	5000	1/2"	50	Kärcher branded bend red restrictor. Wrapped impression, maximum oil resistant tube and cover. 2-wire protection. Includes 2-3/8" FPT twist set couplers.
	15	8.925-251.0	250°F	5000	1/2"	100	Kärcher branded bend red restrictor. Wrapped impression, maximum oil resistant tube and cover. 2-wire protection. Configured 3/8" MPT SOX 3/8" MPTSW

## MISCELLANEOUS HOSES



		Order no.	Max Temp	Max working pressure (PSI)	Length (ft.)	Description
<b>Water supply hose</b>						
	1	4.440-207.0	86°F		25	ID 19 R1" / R 3/4", up to 85 °C, for suction with copper wire for grounding the unit.
<b>Industrial garden hose</b>						
3/4" ID	2	8.711-797.0	212°F	200	25	Built to last, extra-large 3/4" ID Inlet water hose. EPDM cover and tube is perfect for water and provides ozone and heat protection.  2-wire protection Seven times greater abrasion resistance Built to SAE 100R2AT OD dimensions 3/8" MPT Swivel x 3/8" MPT Solid
	3	8.711-798.0	212°F	200	50	
	4	8.711-799.0	212°F	200	75	
	5	8.711-800.0	212°F	200	100	
<b>Sandblast hose</b>						
3/4"	6	8.711-809.0	130°F		/ ft.	Sand, Spiralite /ft
3/4" x 25'	7	8.711-839.0	130°F		25	Assy, Sand, Spiralite
3/4" x 40'	8	8.711-840.0	130°F		40	Assy, Sand, Spiralite
1"	9	8.711-811.0	130°F		/ ft.	Sand, Spiralite /ft
<b>Float tank inlet hose</b>						
8"	10	8.711-773.0	190°F	300		
11"	11	8.711-774.0	190°F	300		
13"	12	8.711-775.0	190°F	300		
30"	13	9.802-257.0	190°F	300		
45"	14	9.802-258.0	190°F	300		
Connector, Fluidmaster ball cock	15	8.707-316.0	190°F	300		
<b>Push-on hose</b>						
1/4" ID	16	9.802-254.0	190°F	300		Fabric braid hose with a Nitrile cover and tube. Easily pushes on to hose barb fitting and good up to 300 PSI.  Fabric braid Nitrile cover -40°F to 212°F
1/2" ID	17	9.802-259.0	190°F	300		
3/4" ID	18	9.802-261.0	190°F	300		
<b>Vinyl tubing</b>						
1/4" x 1/2"	19	9.802-251.0	50°F			Clear vinyl / ft. - available by the foot or in 100' rolls
1/4" x 1/2"	20	9.802-252.0	250°F			Braided vinyl / ft. - available by the foot or in 100' rolls

**NEW**  
**Stronger**  
**Frame**

# HOSE REELS AND BRACKETS



		Order no.	Length (ft.)	Description
<b>Ready-Stack hose reels</b>				
Ready-Stack hose reels	1	9.801-763.0	100	Mild steel, 6000 PSI, 350°F
	2	9.801-764.0	200	Mild steel, 6000 PSI, 350°F
	3	9.801-765.0	100	Stainless Steel, 6000 PSI, 350°F
	4	9.801-766.0	200	Stainless Steel, 6000 PSI, 350°F
	5	8.923-415.0	100	Hose Guide for 100 Ft Reel
	6	8.923-427.0	200	Hose Guide for 200 Ft Reel
	7	8.923-416.0		Hose Reel Riser, feed hose over and around obstacles
	8	8.923-918.0		Reel Cart System, easily move multiple hoses and reels where needed.
<b>Automatic, self-winding hose reels</b>				
Self-winding hose reel	9	2.639-919.0	66	For wall mounting of high-pressure hose.
Swivel wall mount bracket	10	2.639-931.0		Hose and bracket (2.639-931.0) sold separately.
<b>Manual hose reels</b>				
HD Classic hose reel	11	9.801-253.0		Non-pivoting with mounting kit for HD gas series. 4000 PSI, 225° F, connects to standard 22 mm high-pressure hose. Hose sold separately.
Jumper hose	12	9.162-154.0		
Fixed Based	13	8.750-682.0	100	5000 PSI, 325° F, equipped for 3/8" hose. 2-year warranty.
Pivot Reel	14	8.750-685.0	100	5000 PSI, 325° F, equipped for 3/8" hose. 2-year warranty.
Fixed Based	15	8.750-683.0	200	5000 PSI, 325° F, equipped for 3/8" hose. 2-year warranty.
Pivot Reel	16	8.750-684.0	100	5000 PSI, 325° F, equipped for 3/8" hose. 2-year warranty.
Pivot Reel, Trailer Mount	17	8.920-146.0		
Pivot Reel, Trailer Mount	18	8.920-147.0		
<b>Hose reel brackets</b>				
Mounting kit for HDS full size units	19	9.801-418.0		Hose sold separately.
Trailer Mount Support, Pivot Reels	20	8.920-127.0	33	
Universal Mount	21	8.919-430.0	50	
Skid Mount	22	8.919-794.0	100	
Wall Mount	23	8.919-437.0	50	
Base Mount	24	8.919-434.0		
Bracket, Universal	25	8.919-072.0		
Bracket, 90°	26	8.919-445.0		
Bracket, 45°	27	8.919-441.0		
Bracket, Vertical	28	8.919-448.0		

# HOSE REEL SWIVELS



		Order no.	Description
<b>Hose reel swivels</b>			
1/2" M x 3/8" F	1	9.118-021.0	5000 PSI, stainless steel rotor, unique dual seal for extra long life. 2-year warranty.
1/2" F x 3/8" F	2	9.118-022.0	
3/8" M x 3/8" F	3	9.118-023.0	
3/8" F x 3/8" F	4	9.118-024.0	
1/2" M x 1/2" F	5	9.118-025.0	
1/2" F x 1/2" F	6	9.118-026.0	
3/8" M x 1/2" F	7	9.118-027.0	
3/8" F x 1/2" F	8	9.118-028.0	
1/2" M x 3/8" F	9	9.118-020.0	Extended swivels - protects hose and limits bend and hose stress
1/2" F x 3/8" F	10	9.118-029.0	
3/8" M x 3/8" F	11	9.118-030.0	
3/8" F x 3/8" F	12	9.118-031.0	
3/8" F x 1/2" F	13	9.118-032.0	
3/8" M x 1/2" F	14	9.118-033.0	
1/2" F x 1/2" F	15	9.118-034.0	
1/2" M x 1/2" F	16	9.118-035.0	



# WASH BRUSHES



		Order no.	Flow rate	Description
<b>Push-on wash brush</b>				
Push-on wash brush	1	4.762-016.0		For use with hot or cold water Classic machines. Clamps directly onto 18 mm spray lance.
Push-on wash brush; EASY!Lock threading	2	4.113-001.0		
Push-on wash brush	3	4.762-444.0		For use with cold water Classic machines. Mounts onto double or triple nozzles.
<b>Rotating wash brush</b>				
Rotating wash brush	4	4.762-559.0	> 4 GPM	Nylon bristles. Driven by water jet, gently removes fine dust and traffic film from all surfaces. For use with hot or cold water Classic machines. Clamps directly onto 18 mm spray lance.
Rotating wash brush	5	4.762-561.0	up to 4 GPM	
Rotating wash brush; EASY!Lock threading	6	4.113-004.0	up to 4 GPM	
Rotating wash brush; EASY!Lock threading	7	4.113-002.0	> 4 GPM	
Rotating wash brush	8	4.762-560.0	up to 4 GPM	Natural bristles. Driven by water jet, gently removes fine dust and traffic film from all surfaces. For use with hot or cold water Classic machines. Clamps directly onto 18 mm spray lance.
Rotating wash brush; EASY!Lock threading	9	4.113-003.0	up to 4 GPM	
Rotating wash brush; EASY!Lock threading	10	4.113-005.0	> 4 GPM	

## COUPLINGS AND ADAPTERS



		Order no.	Description
<b>Rotary coupling</b>			
Rotary coupling	1	4.401-091.0	Prevents twisting of high-pressure hoses. Grip protection.
Rotary coupling; EASY!Lock threading	2	4.111-021.0	
22 mm Rotary Hose Connector	3	4.401-076.0	
22 mm x 3/8 FPT	4	9.802-175.0	
<b>Hose Coupling</b>			
Combines two 22 mm HP Hoses	5	4.403-002.0	For connecting and extending two high-pressure hoses. Brass with rubber protector.
Combines two 22 mm HP Hoses; EASY!Lock threading	6	4.111-037.0	
Large Washer	7	6.362-124.0	
Small Washer	8	5.364-129.0	
<b>Hose Coupling</b>			
Nozzle screws / screw socket	9	4.402-022.0	For attaching high-pressure nozzles and accessories to the trigger gun (with nozzle connector), 1 x M 22 x 1.5 / 1 x M 18 x 1.5.
Nozzle screws / screw socket; EASY!Lock threading	10	4.111-022.0	

## TRIGGER GUNS



The new Kärcher EASY!Force trigger gun is the most effortless gun, requiring zero effort. Its cruise control like technology uses its own recoil force to hold the trigger down for you, so no more sore hands after hours of use. This revolutionary gun is offered in two versions: the North American EASY!Force trigger gun with standard threads for our North American engineered pressure washers and accessories, and our EASY!Force trigger gun with EASY!Lock threading for our German engineered machines and EASY!Lock accessory system.

The new EASY!Lock connection system allows set-ups that are five times faster than existing systems. A simple 360° turn provides a fully-threaded, secure connection.

		Order no.	Flow rate	Description
<b>EASY!Force trigger gun</b>				
EASY!Force trigger gun for EASY!Lock threading	1	4.118-005.0		EASY!Lock threading for EASY!Lock accessory system. EASY!Force trigger gun uses the recoil force of the high-pressure spray to reduce the hold force of the trigger to zero.
EASY!Force trigger gun North American Model	2	8.756-481.0 ■		Standard 1/4" connection for wand and 3/8" connection for hose. EASY!Force trigger gun uses the recoil force of the high-pressure spray to reduce the hold force of the trigger to zero.
<b>Easy Press high-pressure gun with holding power reduction (Kärcher patent)</b>				
Easy press trigger gun with soft grip	3	4.775-466.0		Easy Press Trigger Gun, ID 8, 22 mm screw-type connection.
Easy press trigger gun with soft grip	4	4.775-463.0		ID 8, Integrated AVS Connection.
<b>Servo Control</b>				
Servo control	5	4.775-526.0	Less than 3.3 GPM	Servo control for Easy Press trigger guns (4.775-466.0 or 4.775-463.0)
	6	4.118-007.0	Less than 3.3 GPM	Servo control; EASY!Lock threading
	7	4.775-470.0	3.3 to 4.9 GPM	Servo control for Easy Press trigger guns (4.775-466.0 or 4.775-463.0)
	8	4.118-008.0	3.3 to 4.9 GPM	Servo control; EASY!Lock threading
	9	4.775-471.0	Greater than 4.9 GPM	Servo control for Easy Press trigger guns (4.775-466.0 or 4.775-463.0)
	10	4.118-009.0	Greater than 4.9 GPM	Servo control; EASY!Lock threading
<b>Trigger guns</b>				
Trigger Gun	11	4.775-539.0		ID 8, 22 mm connection
Extended Trigger Gun	12	4.775-298.0		ID 6, Integrated AVS hose connection, without pressure gauge
Extended Softgrip Trigger Gun	13	4.775-529.0		Extended Soft-grip Trigger Gun, ID 6, Integrated AVS hose connection
Soft-grip Trigger Gun Replacement	14	4.775-080.0		Soft-grip Trigger Gun Replacement, ID 6, Integral AVS hose connection
Extended Trigger Gun	15	8.754-381.0		Extended Trigger Gun, 22 mm Male / Male Connectors (used on newer Classic HD direct drive units)

■ Please note: NOT compatible with EASY!Lock.

Prices, specifications and product descriptions subject to change without notice.



		Order no.	Flow rate	Description
<b>Quick connect</b>				
Quick Disconnect	16	6.401-458.0		
Quick Disconnect; EASY!Lock threading	17	2.115-000.0		
22 mm x 1/4" quick coupler	18	9.154-045.0		
18 mm x 1/4" quick coupler	19	9.841-659.0		18MM x 1/4" QDC Coupler, 4000 PSI / 175
Hardened stainless steel nipple for coupler	20	6.401.459.0		
<b>Trigger gun repair kits</b>				
Trigger gun repair kit	21	2.880-369.0		for 4.775-041.0
	22	2.880-173.0		for 4.775-012.0; 4.775-010.0 /-015.0 / -017.0
	23	2.880-463.0		for 4.775-056.0
	24	2.883-191.0		for 4.775-079.0
	25	2.883-192.0		for 4.775-080.0
	26	2.883-888.0		For 4.775-254.0
	27	4.427-014.0		EASY!Force trigger gun repair kit: manifold complete with full ceramic valve (for gun 4.118-005.0)
	28	4.427-025.0		EASY!Force trigger gun repair kit: manifold complete with full ceramic valve (for gun 8.756-481.0)
	29	2.885-483.0		EASY!Force trigger gun repair kit: spare part lever kit (for guns 8.756-481.0 and 4.118-005.0)

# SPRAY LANCES



Kärcher standard high-quality stainless steel spray lances, available in various lengths, can be rotated 360° while under pressure. They feature ergonomically shaped grips and large couplings for easy use and insulation. Special spray lances significantly extend the range of uses of high-pressure cleaners.

	Order no.	Max working pressure	Length	Description		
<b>Non-pivoting spray lance</b>						
Non-pivoting spray lance	1	4.760-667.0	10" / 250 mm	Stainless steel with manual coupling. With extended trigger gun.		
Non-pivoting spray wand, 10" / 250 mm; EASY!Lock threading	2	4.112-027.0				
Non-pivoting spray lance	3	4.760-665.0	21" / 550 mm			
Non-pivoting spray wand, 21" / 550 mm; EASY!Lock threading	4	4.112-024.0				
Spray lance	5	9.112-508.0	21" / 550 mm	with Quick Connect Female Threads		
	6	9.802-220.0	21" / 550 mm	with Quick Connect Male Threads		
<b>Pivoting spray lance</b>						
Pivoting spray lance	7	4.760-664.0	4350	Spray pipes in different lengths, stainless steel with large manual coupling. Ergonomic handles ensure optimal handling and protection. Rotatable under pressure by 360°.		
Pivoting spray wand; EASY!Lock threading	8	4.112-007.0	4350			
Pivoting spray lance	9	4.760-663.0	4350			
Pivoting spray wand; EASY!Lock threading	10	4.112-006.0	4350			
Pivoting spray lance	11	4.760-584.0	4350			
Pivoting spray lance; EASY!Lock threading	12	4.112-000.0	4350			
Pivoting spray lance	13	4.760-661.0	4350			
Pivoting spray wand; EASY!Lock threading	14	4.112-018.0	4350			
Pivoting spray lance	15	4.760-662.0	4350			
Pivoting spray wand; EASY!Lock threading	16	4.112-021.0	4350			
Pivoting spray lance	17	4.760-691.0	4350			
Pivoting spray lance	18	4.760-609.0	4350			
<b>Variable pressure spray lance</b>						
Variable pressure spray lance	19	4.760-362.0	4000		26" / 670 mm	With integral pressure gauge for infinitely variable pressure control on lance, nozzle connection 24 mm x 1.5, chemical feed in low-pressure mode.
<b>Specialty lances</b>						
Washroom and gutter lance	20	4.760-073.0	4000			With nozzle insert. Specially shaped for cleaning gutters and hygienically cleaning wash rooms. Stainless steel
Washroom and gutter wand; EASY!Lock threading	21	4.112-029.0	4000			
Underbody spray lance	22	4.760.245.0	4000		27" / 700 mm	Mobile; for convenient and effective cleaning of vehicle underbodies and wheel arches. Stainless steel. Nozzle sold separately.
Underbody spray wand; EASY!Lock threading	23	4.112-032.0	4000	27" / 700 mm		
Gutter cleaning wand; EASY!Lock threading	24	2.112-015.0	4000			

## SPRAY LANCES



	Order no.	Description
<b>O-ring kits</b>		
For use on Kärcher guns, lances, nozzles and more.	25	2.880-154.0 O-rings package of 3
	26	2.880-296.0 O-rings package of 5
	27	2.880-208.0 O-rings package of 20
	28	2.880-168.0 O-rings package of 100
	29	2.880-292.0 O-rings for Swivel Connections, (5-pack: 2 swivel, 3 std)
<b>Repair kits</b>		
	30	2.880-001.0 EASY!Force lance repair kit: quad-ring sealing (3)

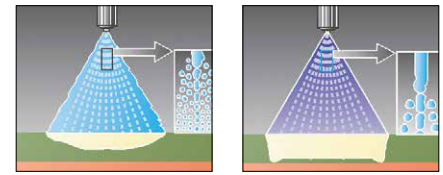

# NOZZLES AND POWER NOZZLES

The Kärcher Power Nozzle, developed and patented by Kärcher, offers a performance that is distinctly better than that of conventional nozzles. The concentrated spray jet of large coherent droplets is sharp-contoured and increases impact pressure by up to 40%. This produces a considerable improvement in cleaning efficiency. Assuming the same degree of soiling, the Power Nozzle cleans at a much faster rate and, an environmentally friendly benefit, uses less water and cleaning agent. The Power Nozzle's spray jet cleans with the same high-impact pressure over its whole working width. This provides substantially more cleaning power for a given amount of energy.



Regular nozzle

Power nozzle

		Order no.	Nozzle size	Description
<b>Nozzle adapter</b>				
Nozzle adapter	1	9.315-002.0		18 mm x 1/4" female. For connecting Kärcher nozzles to non-Kärcher lances.
<b>Nozzle spray angle 0°</b>				
High-pressure nozzle spray angle 0°	2	2.884-533.0	040	Solid jet for removing extremely stubborn dirt.
	3	2.113-001.0	040	EASY!Lock threading. Solid jet for removing extremely stubborn dirt.
	4	2.113-033.0	045	EASY!Lock threading. Solid jet for removing extremely stubborn dirt.
	5	2.884-535.0	050	Solid jet for removing extremely stubborn dirt.
	6	2.113-034.0	050	EASY!Lock threading. Solid jet for removing extremely stubborn dirt.
	7	2.884-536.0	055	Solid jet for removing extremely stubborn dirt.
	8	2.113-035.0	055	EASY!Lock threading. Solid jet for removing extremely stubborn dirt.
	9	2.884-537.0	060	Solid jet for removing extremely stubborn dirt.
	10	2.113-036.0	060	EASY!Lock threading. Solid jet for removing extremely stubborn dirt.
	11	2.884-540.0	075	Solid jet for removing extremely stubborn dirt.
	12	2.884-544.0	110	Solid jet for removing extremely stubborn dirt.
<b>Power nozzle spray angle 15°</b>				
Power nozzle spray angle 15°	13	2.883-388.0	040	Flat stream for stubborn contaminations.
	14	2.113-045.0	040	EASY!Lock threading. Flat stream for stubborn contaminations.
	15	2.883-389.0	045	Flat stream for stubborn contaminations.
	16	2.113-046.0	045	EASY!Lock threading. Flat stream for stubborn contaminations.
	17	2.883-390.0	055	Flat stream for stubborn contaminations.
	18	2.113-047.0	055	EASY!Lock threading. Flat stream for stubborn contaminations.
	19	2.883-391.0	060	Flat stream for stubborn contaminations.
	20	2.113-048.0	060	EASY!Lock threading. Flat stream for stubborn contaminations.
	21	2.883-392.0	070	Flat stream for stubborn contaminations.
	22	2.883-393.0	075	Flat stream for stubborn contaminations.
	23	2.883-394.0	080	Flat stream for stubborn contaminations.
	24	2.113-043.0	036	Power nozzle TR 15036
	25	2.113-062.0	030	Power nozzle TR 1530
<b>Power nozzle spray angle 25°</b>				
Power nozzle spray angle 25°	26	2.883-803.0	034	Fan jet nozzle for large area coverage and tackling dirt and stains.
	27	2.113-000.0	034	EASY!Lock threading. Fan jet nozzle for large area coverage and tackling dirt and stains.
	28	2.883-821.0	036	Fan jet nozzle for large area coverage and stubborn dirt and contaminations.

## KÄRCHER PARTS & ACCESSORIES

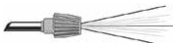

	Order no.	Nozzle size	Description
<b>Power nozzle spray angle 25°</b>			
	29	2.113-005.0	036 EASY!Lock threading. Fan jet nozzle for large area coverage and tackling dirt and stains.
	30	2.883-805.0	038 Fan jet nozzle for large area coverage and tackling stubborn dirt and stains.
	31	2.113-006.0	038 EASY!Lock threading. Fan jet nozzle for large area coverage and tackling dirt and stains.
	32	2.883-397.0	040 Fan jet nozzle for large area coverage and tackling stubborn dirt and stains.
	33	2.113-021.0	040 EASY!Lock threading. Fan jet nozzle for large area coverage and tackling dirt and stains.
	34	2.883-829.0	043 Fan jet nozzle for large area coverage and tackling stubborn dirt and stains.
	35	2.113-008.0	043 EASY!Lock threading. Fan jet nozzle for large area coverage and tackling dirt and stains.
	36	2.883-398.0	045 Fan jet nozzle for large area coverage and tackling stubborn dirt and stains.
	37	2.113-022.0	045 EASY!Lock threading. Fan jet nozzle for large area coverage and tackling dirt and stains.
	38	2.883-399.0	050 Fan jet nozzle for large area coverage and tackling stubborn dirt and stains.
	39	2.113-023.0	050 EASY!Lock threading. Fan jet nozzle for large area coverage and tackling dirt and stains.
	40	2.883-400.0	052 Fan jet nozzle for large area coverage and tackling stubborn dirt and stains.
	41	2.113-024.0	052 EASY!Lock threading. Fan jet nozzle for large area coverage and tackling dirt and stains.
	42	2.883-403.0	065 Fan jet nozzle for large area coverage and tackling stubborn dirt and stains.
	43	2.113-061.0	065 EASY!Lock threading. Fan jet nozzle for large area coverage and tackling dirt and stains.
	44	2.885-133.0	068 Fan jet nozzle for large area coverage and tackling stubborn dirt and stains.
	45	2.113-027.0	068 EASY!Lock threading. Fan jet nozzle for large area coverage and tackling dirt and stains.
	46	2.883-404.0	070 Fan jet nozzle for large area coverage and tackling stubborn dirt and stains.
	47	2.113-028.0	070 EASY!Lock threading. Fan jet nozzle for large area coverage and tackling dirt and stains.
	48	2.883-926.0	072 Fan jet nozzle for large area coverage and tackling stubborn dirt and stains.
	49	2.113-014.0	075 EASY!Lock threading. Fan jet nozzle for large area coverage and tackling dirt and stains.
50	2.883-785.0	110 Fan jet nozzle for large area coverage and tackling stubborn dirt and stains.	
51	2.113-018.0	110 EASY!Lock threading. Fan jet nozzle for large area coverage and tackling dirt and stains.	
52	2.885-157.0	155 Fan jet nozzle for large area coverage and tackling stubborn dirt and stains.	
53	2.113-030.0	155 EASY!Lock threading. Fan jet nozzle for large area coverage and tackling dirt and stains.	
54	2.113-061.0	065 Power nozzle TR 25065	
55	2.113-071.0	032 Power nozzle TR 25032	
<b>Power nozzle spray angle 40°</b>			
	56	2.884-522.0	040 Fan jet for high area performance - suitable for sensitive surfaces.
	57	2.113-003.0	040 EASY!Lock threading. Fan jet for high area performance - suitable for sensitive surfaces.
	58	2.884-523.0	045 Fan jet for high area performance - suitable for sensitive surfaces.
	59	2.113-053.0	045 EASY!Lock threading. Fan jet for high area performance - suitable for sensitive surfaces.
	60	2.884-524.0	050 Fan jet for high area performance - suitable for sensitive surfaces.
	61	2.113-054.0	050 EASY!Lock threading. Fan jet for high area performance - suitable for sensitive surfaces.
	62	2.884-525.0	055 Fan jet for high area performance - suitable for sensitive surfaces.
	63	2.113-055.0	055 EASY!Lock threading. Fan jet for high area performance - suitable for sensitive surfaces.
	64	2.884-526.0	075 Fan jet for high area performance - suitable for sensitive surfaces.
	65	2.113-056.0	075 EASY!Lock threading. Fan jet for high area performance - suitable for sensitive surfaces.
	66	2.884-527.0	080 Fan jet for high area performance - suitable for sensitive surfaces.
	67	2.113-057.0	080 EASY!Lock threading. Fan jet for high area performance - suitable for sensitive surfaces.
	68	2.113-064.0	150 Power nozzle TR 40150



# TRIPLE NOZZLES



Kärcher triple nozzles combine quality, flexibility and cleaning power. The robust and high-quality stainless steel nozzle guarantees a long service life. Choose one of three spray types: 0° high-pressure pencil jet, 25° high-pressure fan jet and 40° low-pressure jet (with cleaning agent suction). The integrated power nozzle contour in the 25° high-pressure fan jet guarantees maximum cleaning power. With the touchless triple nozzle, changeover between 0° pencil jet and 25° fan jet is especially convenient, by simply turning the spray lance.

		Order no.	Max working pressure	Nozzle size	Description
<b>Triple nozzles</b>					
Triple nozzle 028	1	4.767-144.0	4350 PSI	028	Manually selectable triple nozzle with stainless steel nozzle. Robust, durable and non-clogging. Convenient selection of high-pressure pencil jet (0°), high-pressure fan jet with power nozzle (25°) and low-pressure fan jet (40°). For high-pressure cleaners with hs; low-pressure fan jet for cleaning agent removal and application. M 18 x 1.5 connection.
Triple nozzle 031	2	4.767-145.0	4350 PSI	031	
Triple nozzle 032	3	4.767-195.0	4350 PSI	032	
Triple nozzle 032; EASY!Lock threading	4	4.117-027.0	4350 PSI	032	
Triple nozzle 033	5	4.767-146.0	4350 PSI	033	
Triple nozzle 034	6	4.767-147.0	4350 PSI	034	
Triple nozzle 034; EASY!Lock threading	7	4.117-029.0	4350 PSI	034	
Triple nozzle 036	8	4.767-148.0	4350 PSI	036	
Triple nozzle 038	9	4.767-149.0	4350 PSI	038	
Triple nozzle 040	10	4.767-150.0	4350 PSI	040	
Triple nozzle 040; EASY!Lock threading	11	4.117-033.0	4350 PSI	040	
Triple nozzle 042	12	4.767-151.0	4350 PSI	042	
Triple nozzle 043	13	4.767-152.0	4350 PSI	043	
Triple jet nozzle 045	14	4.767-153.0	4350 PSI	045	
Triple nozzle 045; EASY!Lock threading	15	4.117-036.0	4350 PSI	045	
Triple nozzle 050	16	4.767-154.0	4350 PSI	050	
Triple nozzle 050; EASY!Lock threading	17	4.117-037.0	4350 PSI	050	
Triple nozzle 055; EASY!Lock threading	18	4.117-039.0	4350 PSI	055	
Triple jet nozzle 060	19	4.767-157.0	4350 PSI	060	
<b>Triple nozzle</b>					
Triple nozzle	20	2.113-004.0		035	
	21	2.113-023.0		050	
	22	2.113-014.0		075	
	23	2.113-017.0		100	

## TRIPLE NOZZLES



1-3, 5, 6, 8-10, 12-14, 16, 19



4, 7, 11, 15, 17, 18



20, 21, 22, 23



24, 25, 26, 27, 28, 29



30, 31, 32, 33, 34



36, 37, 38, 39

		Order no.	Max working pressure	Nozzle size	Description
<b>Triple nozzle, touchless changeover</b>					
Triple nozzle, touchless changeover	24	4.767-001.0	4350 PSI	034	Fast and easy jet changeover by flicking the nozzle. Choice of high-pressure pencil jet or high-pressure fan jet (25°), with manual changeover to low-pressure fan jet (40°). For high-pressure cleaners with injectors; low-pressure fan jet for cleaning agent removal and application. M 18 x 1.5 connection.
	25	4.767-065.0	4350 PSI	050	
	26	4.767-066.0	4350 PSI	055	
	27	4.767-067.0	4350 PSI	060	
	28	4.767-068.0	4350 PSI	080	
	29	4.767-069.0	4350 PSI	120	
<b>Angle vario nozzle 0°-90°</b>					
Angle vario nozzle 0°-90°	30	4.763-039.0	4350 PSI	050	Allows variable adjustment of the high-pressure jet spray angle from 0-90°. This allows easy adaptation to all types of contaminations and surfaces.
	31	4.763-058.0	4350 PSI	055	
	32	4.763-036.0	4350 PSI	080	
	33	4.113-008.0	4350 PSI		EASY!Lock threading. Allows variable adjustment of the high-pressure jet spray angle from 0-90°. This allows easy adaptation to all types of contaminations and surfaces.
	34	4.113-006.0	4350 PSI		
<b>Changeover nozzles</b>					
Double changeover nozzles	35	4.764-177.0	4350 PSI	031, 0° and 25°	
	36	4.767-197.0	4350 PSI	034	
	37	4.767-198.0	4350 PSI	040	
	38	4.767-199.0	4350 PSI	045	
	39	4.767-201.0	4350 PSI	055	

# ROTARY NOZZLES



The Kärcher dirt-blaster combines the advantages of pencil jets and fan jets. The nozzle spins at approximately 4,000 rpm to apply a powerful cleaning spray to a large area.

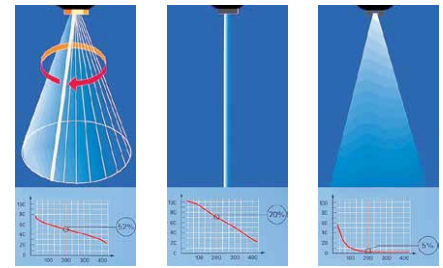

Rotating pencil jet

Pencil jet

Fan jet

		Order no.	Max working pressure	Nozzle size	Description
<b>Dirt Blaster, small</b>					
Dirt Blaster	1	4.767-229.0	2600 PSI	030	Dirt Blaster - rotating pencil jet - 10 times the cleaning power . Highest Stand Ceramic nozzle / nozzle and bearing ring . Max . 180 bar / 18 MPa , 60° C.
	2	4.114-018.0	2600 PSI	030	EASY!Lock threading. Dirt Blaster - rotating pencil jet - 10 times the cleaning power . Highest Stand Ceramic nozzle / nozzle and bearing ring . Max . 180 bar / 18 MPa , 60° C.
	3	4.767-230.0	2600 PSI	035	Dirt Blaster - rotating pencil jet - 10 times the cleaning power . Highest Stand Ceramic nozzle / nozzle and bearing ring . Max . 180 bar / 18 MPa , 60° C.
	4	4.114-019.0	2600 PSI	035	EASY!Lock threading. Dirt Blaster - rotating pencil jet - 10 times the cleaning power . Highest Stand Ceramic nozzle / nozzle and bearing ring . Max . 180 bar / 18 MPa , 60° C.
	5	4.767-231.0	2600 PSI	040	Dirt Blaster - rotating pencil jet - 10 times the cleaning power . Highest Stand Ceramic nozzle / nozzle and bearing ring . Max . 180 bar / 18 MPa , 60° C.
	6	4.114-020.0	2600 PSI	040	EASY!Lock threading. Dirt Blaster - rotating pencil jet - 10 times the cleaning power . Highest Stand Ceramic nozzle / nozzle and bearing ring . Max . 180 bar / 18 MPa , 60° C.
	7	4.767-232.0	2600 PSI	045	Dirt Blaster - rotating pencil jet - 10 times the cleaning power . Highest Stand Ceramic nozzle / nozzle and bearing ring . Max . 180 bar / 18 MPa , 60° C.
	8	4.114-021.0	2600 PSI	045	EASY!Lock threading. Dirt Blaster - rotating pencil jet - 10 times the cleaning power . Highest Stand Ceramic nozzle / nozzle and bearing ring . Max . 180 bar / 18 MPa , 60° C.
	9	4.767-233.0	2600 PSI	050	Dirt Blaster - rotating pencil jet - 10 times the cleaning power . Highest Stand Ceramic nozzle / nozzle and bearing ring . Max . 180 bar / 18 MPa , 60° C.
	10	4.114-022.0	2600 PSI	050	EASY!Lock threading. Dirt Blaster - rotating pencil jet - 10 times the cleaning power . Highest Stand Ceramic nozzle / nozzle and bearing ring . Max . 180 bar / 18 MPa , 60° C.
<b>Dirt Blaster, large</b>					
Dirt Blaster	11	4.114-040.0	4350 PSI	035	Dirt blaster - rotating point jet - 10 times the cleaning performance. Ceramic nozzle / bearing ring provides long service life. Max. 180 bar / 18 MPa, 60°C.
	12	4.114-041.0	4350 PSI	040	
	13	4.114-042.0	4350 PSI	045	
	14	4.114-027.0	4350 PSI	050	
	15	4.114-036.0	4350 PSI	055/060	
	16	4.114-030.0	4350 PSI	070/080	
<b>Quick connect</b>					
Quick connect	17	9.154-023.0	2600 PSI		Convert from screw-connect to Quick Connect 18 mm
<b>Dirt Blaster filter</b>					
Dirt Blaster filter	18	4.730-032.0			

## ROTARY NOZZLES



1, 3, 5, 7, 9



2, 4, 6, 8, 10



11-15

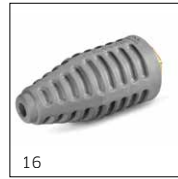

16



19-31

		Order no.	Max working pressure	Nozzle size	Description
<b>Dirt Blaster repair kits</b>					
Dirt Blaster repair kits	19	2.883-473.0			055/060
	20	2.883-471.0			040
	21	2.883-472.0			050
	22	2.883-474.0			070/080
	23	9.302-231.0			045
	24	2.884-114.0			065
	25	2.884-051.0			100/120
	26	2.884-052.0			035
	27	2.883-810.0			4.763-949/-955
	28	2.883-811.0			4.763-950/-956
	29	2.883-813.0			4.763-952/-958
	30	2.884-113.0			4.763-988.0
	31	2.884-114.0			4.763-989.0



# STEAM JET NOZZLES



		Order no.	Nozzle size	Description
<b>Steam nozzle</b>				
	1	4.766-024.0	055	50° fan jet for cleaning and thawing in steam mode, e.g. thawing sand and gravel, de-icing form work, dewaxing vehicles.
	2	2.114-001.0	045	EASY!Lock threading. 50° fan jet for cleaning and thawing in steam mode, e.g. thawing sand and gravel, de-icing form work, dewaxing vehicles.
	3	2.885-039.0	050	50° fan jet for cleaning and thawing in steam mode, e.g. thawing sand and gravel, de-icing form work, dewaxing vehicles.
	4	2.885-119.0	055	50° fan jet for cleaning and thawing in steam mode, e.g. thawing sand and gravel, de-icing form work, dewaxing vehicles.
	5	2.885-049.0	065	50° fan jet for cleaning and thawing in steam mode, e.g. thawing sand and gravel, de-icing form work, dewaxing vehicles.
	6	2.114-005.0	065	EASY!Lock threading. 50° fan jet for cleaning and thawing in steam mode, e.g. thawing sand and gravel, de-icing form work, dewaxing vehicles.
	7	2.885-041.0	070	50° fan jet for cleaning and thawing in steam mode, e.g. thawing sand and gravel, de-icing form work, dewaxing vehicles.
	8	2.114-006.0	070	EASY!Lock threading. 50° fan jet for cleaning and thawing in steam mode, e.g. thawing sand and gravel, de-icing form work, dewaxing vehicles.
	9	2.114-010.0	090	EASY!Lock threading. 50° fan jet for cleaning and thawing in steam mode, e.g. thawing sand and gravel, de-icing form work, dewaxing vehicles.
<b>Nozzle protector for steam nozzle</b>				
Nozzle protector (rubber)	10	5.394-059.0		Nozzle protection for steam jet nozzles 4.766-023.0 and 4.766-024.0.
<b>Dual nozzle holder</b>				
Dual nozzle holder	11	4.764-012.0		Dual nozzle holder
<b>Nozzle union</b>				
Nozzle connector	12	5.401-210.0		With protector for high-pressure and power nozzles M 18 x 1.5.
Nozzle connector; EASY!Lock threading	13	4.112-011.0		
<b>Spacer (including nozzle union)</b>				
Spacer (incl. nozzle union)	14	5.394-294.0		Spacer with nozzle connector - fits 18 mm lance connections

# PIPE CLEANING



		Order no.	Max working pressure	Nozzle size	Diameter	Description
<b>Pipe cleaning hose</b>						
Pipe cleaning hose, ID 6, 30 m, 100 ft.	1	6.390-029.0	1740 PSI			Extremely flexible high-pressure hose for cleaning inside pipes (threaded connection for R 1/8 nozzle).
Pipe cleaning hose, ID 6, 20 m, 66 ft.; EASY!Lock threading	2	6.110-008.0	2900 PSI			
<b>Pipe cleaning nozzles</b>						
Pipe cleaning nozzle 3 x 30° backwards	3	5.763-015.0		055	16 mm	With R 1/8" fitting for attachment to pipe cleaning hose. 
	4	5.763-017.0		050	30 mm	
	5	5.763-021.0		070	30 mm	
Pipe cleaning nozzle 1 x forward, 3 x 30° backwards	6	5.763-016.0		060	16 mm	With R 1/8" fitting for attachment to pipe cleaning hose. 
	7	5.763-020.0		065	16 mm	
<b>Rotating jets</b>						
4 rotating jets	8	6.415-428.0		050	16 mm	With R 1/8" fitting for attachment to pipe cleaning hose. 
	9	6.415-440.0		065	16 mm	
<b>Brass nozzles - direct connections to 22 mm high-pressure hose</b>						
Brass nozzles - direct connections to 22 mm high-pressure hose	10	5.763-011.0				Brass nozzle, 830 PSI / 3.5 GPM - direct connects to 22 mm
	11	5.763-013.0				Brass nozzle, 800 PSI / 5.3 GPM - direct connects to 22 mm

# SURFACE CLEANERS

Surface cleaners offer a massive area performance and clean without splashing. They come with a plastic and stainless steel hood for hot water cleaning applications.

		Order no.	Flow rate	Diameter	Description	
<b>Surface Cleaner FR Classic</b>						
Surface Cleaner FR Classic; EASY!Lock threading - nozzles sold separately	1	2.111-016.0	2.6 GPM	12"	The entry-level model of Kärcher Hard surface cleaner for the splash-proof cleaning of surfaces in indoor and outdoor applications. Nozzle kit has to be ordered separately. Max. 150 bar / 600 l / h / 40°C .	
Surface Cleaner FR Classic DIY - includes nozzle kit	2	2.111-017.0	2.6 GPM	12"		
<b>Hard surface cleaner FR TR 30 ME</b>						
Hard surface cleaner FR TR 30 ME; EASY!Lock threading - nozzles sold separately	3	2.111-013.0		12"	<p>The FR TR 30 ME hard surface cleaner is an indispensable accessory for efficient and economical professional cleaning – both indoor and outdoor. Rotating Power Nozzles, protected by a stainless steel housing, boost your cleaning coverage area by a factor of 10!</p> <p>With the FR TR 30 ME, you save time and achieve perfectly uniform results without splashing or getting wet. Equipped with an integrated vacuum connection, the FR TR 30 ME is ideal for cleaning indoor areas that would be impractical with other surface cleaners. Wall cleaning is just as convenient thanks to ergonomic handles and direct connection to a trigger gun. Use with both cold and hot water pressure washers. The versatility of the FR TR 30 ME is appreciated in workshops and industrial kitchens, as well as by contract cleaners and municipalities.</p> <p>Maximum pressure: 3625 PSI Max temperature: 175° F</p>	
<b>Hard surface cleaner FR 50 ME</b>						
Hard surface cleaner FR 50 ME; EASY!Lock threading	4	2.111-023.0		20"	<p>With a 20" cleaning area, the FR 50 ME provides a greatly increased coverage area to make quick work of bigger cleaning jobs. The rotating nozzle beam has a swivel joint with ceramic bearings, and is built with a durable rust-free stainless steel housing that connects directly to standard Kärcher trigger guns. The unit's handle design and three non-marking casters ensure easy operation. Detergents can be added through a low pressure valve. Use with Kärcher Power Nozzles (sold separately) for the most thorough and uniform cleaning possible.</p> <p>Maximum pressure: 3625 PSI Max temperature: 175° F</p>	
<b>Machine-specific nozzle kit for FR</b>						
Nozzle packet for surface cleaners nozzles sold separately	5	2.640-482.0	1.9-2.1 GPM		Unit specific nozzle kit: Kärcher power nozzle for surface cleaners.	
	6	2.640-401.0	2.2-2.9 GPM			
	7	2.639-187.0	2.9-4.0 GPM			
	8	2.640-442.0	4.0-4.9 GPM			
	9	2.639-188.0	4.8-5.7 GPM			
	10	2.640-781.0	5.7-7.9 GPM			
	11	2.640-282.0	8.0-9.7 GPM			
	12	2.885-436.0				Nozzle packet for FR Classic, FR Classic DIY, Pro HD 400 and 600
	13	2.885-313.0			Nozzle packet for FR Classic, Pro HD 400	
	14	2.885-312.0			Nozzle packet for FR Classic	
	<b>Adapters</b>					
	Adaptor to connect gun directly to FR 30	15	4.402-022.0			
	Adaptor to connect gun directly to FR 30; EASY!Lock threading	16	4.111-038.0			

## SURFACE CLEANERS WITH SUCTION



		Order no.	Flow rate	Diameter	Description
<b>Hard surface cleaner FRV 30</b>					
Hard surface cleaner FRV 30; EASY!Lock threading - nozzles sold separately	17	2.111-010.0		12"	FRV 30 with integrated, automatic dirty water pickup makes cleaning even more efficient - suitable for indoor and outdoor use. Rinsing after cleaning is unnecessary as the dirty water can be conveniently removed with the supplied 5 m suction hose. Non-marking swivel castors and double ceramic bearings are further quality features. Order unit-specific nozzle kit separately.
Extension hose	18	4.440-939.0			5 m, includes adapter
Adapter	19	4.402-022.0			18 mm x 22 mm Adaptor to connect gun directly to FR30
Adapter; EASY!Lock threading	20	4.111-022.0			
Dirt Trap	21	2.642-532.0			Galvanized steel bucket for collecting coarse dirt and for fixing the suction hose in outside areas.
Suction cup kit for extension hose	22	2.642-528.0			Suction cup for fixing the suction hose to smooth surfaces.
Extension hose	23	4.441-040.0			Extension suction hose, 16' with coupling (fits FRV 30 Me)
<b>Machine-specific nozzle kit for FRV</b>					
Nozzle packet for surface cleaners nozzles sold separately	24	2.642-430.0	1.9-2.1 GPM		Unit specific nozzle kit: Kärcher power nozzles and venturi nozzle for FRV 30.
	25	2.642-431.0	2.2-2.9 GPM		
	26	2.642-432.0	2.9-4.0 GPM		
	27	2.642-433.0	4.0-4.9 GPM		
<b>Hard surface cleaner FRV 50 ME</b>					
Hard surface cleaner FRV 50 ME	28	2.643-598.0			Hard surface cleaner FRV 50 ME
Hard surface cleaner FRV 50 ME; EASY!Lock threading	29	2.111-024.0			Hard surface cleaner FRV 50 ME; EASY!Lock threading
FRV 50 Me suction hose	30	4.441-078.3			
FRV 50 Me extension hose	31	4.441-040.0			
FRV 50 Me attachment kit hose clamp	32	2.642-528.0			
FRV 50 Me kit mud	33	2.642-532.0			
<b>Power Nozzle for Hard surface cleaner FRV 50 ME</b>					
Power nozzle	34	2.642-430.0			FRV 50 Me power nozzle 035
	35	2.642-431.0			FRV 50 Me power nozzle 040
	36	2.642-432.0			FRV 50 Me power nozzle 045
	37	2.642-433.0			FRV 50 Me power nozzle 050
	38	2.642-982.0			FRV 50 Me power nozzle 080



## WET BLASTING ATTACHMENTS



The wet blasting attachment fits easily on Kärcher high-pressure cleaner spray lances. The abrasive is sucked up into the water jet and applied with a powerful abrasive action. Ideal for removing rust, scale and paint from components as well as graffiti.



		Order no.	Nozzle size	Description
<b>Wet blasting attachment (without nozzle)</b>				
Wet blasting attachment with flow control	1	4.762-010.0		Adds abrasive to high-pressure jet. For removing paint, rust, scaling. Fits on spray lance in place of HP nozzle. With flow control. (Without nozzles)
Wet blasting attachment with flow control; EASY!Lock	2	4.115-000.0		
Wet blasting attachment without flow control	3	4.762-022.0		Adds abrasive to high-pressure jet. For removing paint, rust, scaling. Fits on spray lance in place of HP nozzle. Without flow control. (Nozzles not included)
Wet blasting attachment without flow control; EASY!Lock	4	4.115-006.0		
<b>Nozzle pack for wet blasting attachment</b>				
Nozzle kit for wet blasting attachment	5	2.638-526.0	035	Consisting of wet blasting nozzle and nozzle insert - use in conjunction with wet blasting attachment (4.762-010.0 / -022.0)
	6	2.637-900.0	040	
	7	2.637-901.0	045	
	8	2.637-902.0	050	
	9	2.637-903.0	055	
	10	2.637-904.0	060	
		2.112-021.0	0035	
		2.112-019.0	0040	
		2.112-022.0	0045	
		2.112-023.0	0050	
	2.112-024.0	0055		
	2.112-025.0	0060		
	2.112-026.0	0065		
Nozzle kit - sand nozzle only	12	5.769-011.0		
<b>Boron carbide nozzle</b>				
Boron carbide nozzle	13	6.415-084.0	6 mm	In addition to nozzle packs. Highly wear-resistant blasting nozzle with boron carbide lining for continuous use.
	14	6.415-083.0	8 mm	

## FOAM SYSTEMS AND CLEANING AGENT INJECTORS

		Order no.	Flow rate	Description
<b>Inno Foam kit</b>				
Inno Foam System, for models that dispense detergent at low pressure. (Purchase nozzle insert separately)	1	2.640-151.0		Kärcher's complete, ready-to-use high pressure foaming system is a twin spray lance and precision chemical injection system. The patent-pending dual spray lance provides a multitude of functions for many washing applications.
Inno Foam System, for models that dispense detergent at low pressure; EASY!Lock threading. (Purchase nozzle insert separately)	2	2.112-000.0		Apply a thick layer of foam using the Inno foam nozzle, then switch easily to high pressure for clear rinsing. The dual lance can be equipped with your choice of high pressure nozzles.
Inno Foam System, for models that dispense detergent at high pressure. (Purchase nozzle insert separately)	3	2.640-692.0		The chemical injection system provides precise detergent metering (0-5% concentration), providing faster and more consistent results using the optimum amount of detergent.
Inno Foam System, for models that dispense detergent at high pressure; EASY!Lock threading. (Purchase nozzle insert separately)	4	2.112-008.0		Lance Length: 25.6" Maximum Pressure: 3700 PSI Maximum Flow Rate: 5.8 GPM Maximum Temperature: 176°F

## FOAM SYSTEMS AND CLEANING AGENT INJECTORS (CONTINUED)



		Order no.	Flow rate	Description
<b>Easy Foam Set</b>				
Easy Foam Set with RM injector	5	2.640-691.0		Easy Foam System, for models that dispense detergent at low pressure (purchase nozzle insert separately)
Easy Foam Set with RM injector; EASY!Lock threading	6	2.112-010.0		
Easy Foam Set	7	2.640-693.0		Easy Foam System, for models that dispense detergent at high pressure. (Purchase nozzle insert separately)
<b>Easy Foam Bottle</b>				
Easy Foam bottle for EASY!Lock threading	8	2.112-017.0		Nozzle size 025, for machines with Servo Control function
	9	2.112-018.0		Nozzle size 042, for machines without Servo Control function
<b>Foam Nozzle Inserts for Inno / Easy Sets</b>				
Foam nozzle inserts; EASY!Lock - nozzles sold separately	10	2.111-009.0	2.2-2.6 GPM	
Foam nozzle inserts - nozzles sold separately	11	2.640-687.0	2.7-3.0 GPM	
Foam nozzle inserts; EASY!Lock - nozzles sold separately	12	2.111-018.0	2.7-3.0 GPM	
Foam nozzle inserts - nozzles sold separately	13	2.640-688.0	3.1-4.4 GPM	
Foam nozzle inserts; EASY!Lock - nozzles sold separately	14	2.111-019.0	3.1-4.4 GPM	
Foam nozzle inserts - nozzles sold separately	15	2.640-689.0	4.5-5.8 GPM	
Foam nozzle inserts; EASY!Lock - nozzles sold separately	16	2.111-020.0	4.5-5.8 GPM	
<b>Foam nozzle mounting kit</b>				
Foam nozzle attachment kit; EASY!Lock threading	17	2.112-013.0		For applying foam detergent in metered quantities in sanitary and food areas, or where long reaction time is needed. Fits all units and mounts to spray lance in place of HP nozzle.
<b>High-pressure detergent injector</b>				
High-Pressure Detergent Injector	18	3.637-170.0		Cleaning agent dosage at high-pressure 3-5%
High-Pressure Detergent Injector; EASY!Lock threading	19	4.637-033.0		
Cleaning agent injector for high and low pressure (without nozzles, downstream)	20	3.637-001.0		Dosage of detergents. Separately from the machine in low and high pressure. Dosage up to 15%.
Cleaning agent injector for high and low pressure; EASY!Lock threading (without nozzles, downstream)	21	4.637-032.0		
<b>Machine-specific nozzle kits with order no. 3.637-170.0</b>				
Nozzle Kit - HD units	22	4.769-045.0	2.2-3.0 GPM	
Nozzle Kit - HDS units	23	4.769-046.0	2.2-3.0 GPM	
Nozzle Kit - HD and HDS units	24	4.769-047.0	3.3-4.4 GPM	
Nozzle Kit - HD and HDS units	25	4.769-048.0	4.4-5.3 GPM	
<b>Machine-specific nozzle kits with order no. 3.637-001.0</b>				
High-pressure nozzle insert	26	4.769-003.0	up to 4.9 GPM	
High-pressure nozzle insert	27	4.769-002.0	4.9+ GPM	
Low-pressure nozzle insert	28	4.769-001.0	up to 4.9 GPM	
Low-pressure nozzle insert	29	4.769-006.0	4.9+ GPM	

# OTHER ACCESSORIES



		Order no.	Description
<b>Fine-mesh water filter</b>			
Fine-mesh water filter, 100 µm, R 3/4"	1	2.637-691.0	For connection to unit inlet, 100 µm.
Water fine filter, 90-120 µm, R 1"	2	2.638-255.0	Fits on unit, suitable for pressure and suction, 90-120 µm.
Fine-mesh water filter with adapter	3	4.730-102.0	Connects to unit, 125 µm, with R 3/4" / 1" adapter.
Fine-mesh water filter, 100 µm, R 1"	4	2.638-270.0	For connection to unit inlet, 100 µm.
<b>Suction filter</b>			
Suction filter with check valve	5	4.730-012.0	
HDS GHF x mm Screw Union	6	4.401-073.0	
HD GHF x mm Screw Union (plastic)	7	4.401-059.0	
18 mm (F) x 22 mm (M) Adapter; EASY!Lock threading	8	4.402-022.0	
22 mm x 3/8 QC	9	9.154-045.0	
<b>Flue pipe</b>			
4.75" (120 mm) outlet	10	4.656-149.0	HDS 1.7/12 U Ed; HDS Compact; HDS 1000 BE/DE; HDS Mid-Class (2005-2011)
6.25" (158 mm) outlet	11	4.656-079.0	HDS Full Size Units
7.9" (200 mm) outlet	12	4.656-080.0	HDS 1.7/12 U Ed; HDS
8", 12V DC, Barometric Dampener	13	8.717-764.0	
10", 12V DC, Power Dampener	14	8.749-806.0	
12", 12V DC, Power Dampener	15	8.753-171.0	
8", Round	16	8.717-728.0	
10", Round	17	9.801-040.0	
12", Round	18	8.717-730.0	
10", Exhaust Stack, Cap	19	8.717-731.0	
12", Exhaust Stack, Cap	20	8.717-732.0	
8" without Stack, new style kit	21	8.903-430.0	
8" without Stack, new style	22	8.717-745.0	
<b>Detergent injectors</b>			
Injector, 1-2 GPM, 0.057	23	8.709-404.0	Brass Housing with Stainless Steel nipple
Injector, 2-3 GPM, 0.070	24	9.802-215.0	3500 or 5000 PSI
Injector, 3-5 GPM, 0.083	25	9.802-216.0	Non-Adjustable Metering Viton Seals
Injector, 3-5 GPM, 0.083, 5,000 PSI	26	9.802-217.0	Rated up to 190°F/ 88°C
Injector Assembly, 1-2 GPM, 0.057	27	8.904-464.0	3/8" Q/C Inlet/Outlet
Injector Assembly, 2-3 GPM, 0.070	28	8.929-062.0	
Injector Assembly, 3-5 GPM, 0.083	29	9.802-225.0	
Injector Assembly, 3-5 GPM, 5,000 PSI	30	9.802-226.0	
Injector Repair Kit	31	8.704-199.0	

## OTHER ACCESSORIES



		Order no.	Description
<b>Voltage regulator</b>			
25 Amp, 15 Volt	1	9.802-531.0	
<b>Switches</b>			
Reed switch - HDS Compact Range	2	2.883-477.0	HDS 1.7/12 U Ed; HDS 500 Ci; HDS 600 Ci; HDS 900 Ci
Reed switch - HDS Classic Full Size	3	2.880-000.0	(2005-2011)
Reed switch - HDS Classic Skids	4	2.880-194.0	HDS 1000 BE/DE; HDS 801 B; HDS 745; HDS 895; HDS 945; HDS 1000; HDS 1055; HDS 1195
Reed switch - HDS Classic Full Size	5	2.885-240.0	(2012 Forward)
On/off rotary switch, 115-230V	6	9.802-449.0	1PH 3-position
On/off rotary switch, 230/460V	7	8.716-027.0	3PH 3-position
On/off rotary switch, 120-600V	8	9.802-450.0	1-3PH 2-position
Adjustable thermostat switch/discharge	9	8.750-094.0	150°C/302°F, 2 meter capillary
Adjustable thermostat switch/discharge	10	8.750-095.0	120°C/240°F, 2 meter capillary
Adjustable thermostat switch, 300°	11	9.802-285.0	
<b>Kärcher 500 flow switch</b>			
Vertical mount only	13	8.712-244.0	Tough, impact-resistant, glass-reinforced, nylon housing. Tungsten contact reed switch. Heavy-duty machine brass internals. Viton seals. For solenoid control only. 1-8 GPM. 4350 PSI. 3/8" FPT Inlet / Outlet. 190°F. 1 Amp switch. 2 Wire Reed. 63" wire length.
Mount in any position (gray)	14	8.933-006.0	
Reed switch only (2-wire)	15	9.803-266.0	
<b>Float tanks</b>			
NG/LPG Float Tank, Universal Plastic Float Tank	16	9.802-084.0	3.5 gallon capacity. 22" x 13-1/2" x 5". Heavy 3/16" durable plastic. Convenient mounting tabs.
Lid & Hinges for 9.802-084.0	17	8.912-233.0	
<b>Fuel tanks</b>			
Fuel Tank, 5 Gallon Black	18	9.802-079.0	Rugged fill neck cap with vent
Fuel Tank, 6 Gallon Black	19	9.802-081.0	
Fuel Tank, 8 Gallon Black	20	8.706-615.0	
Fuel Tank, 9 Gallon Black	21	9.802-089.0	
<b>Fuel caps</b>			
Cap, 14" with Fuel Gauge, Red	22	9.803-536.0	
Cap, 14" with Fuel Gauge, Black	23	9.803-535.0	
<b>Plastic dip tube assembly</b>			
Diptube, Plastic, 10" HDS Classic Skid	24	9.803-531.0	
Diptube, rubber bushing	25	9.802-053.0	

# AXIAL PUMPS, REPAIR KITS AND TOOLS



Kärcher’s commercial-duty 3-piston axial pumps are simple, efficient, and very reliable and have fewer moving parts compared to crank-case and piston type pumps.

These proprietary pumps are engineered for long life with features like brass cylinder heads, ceramic pistons, and stainless steel valves. Kärcher’s combined pump/motor units run cooler due to their unique water cooled design. And they use less power thanks to a unique drive center and wobble plate design.

Kärcher pumps feature a soft-dampening system to reduce pulsations in the high pressure system, increasing the service life of high pressure components.

	Order no.	Shaft	GPM	PSI	RPM
<b>Kärcher axial pumps</b>					
	9.120-021.0	3/4"	2.6	3000	3400
	9.120-020.0	5/8"	2.6	3000	3400
<b>Geared reduction for Kärcher pumps</b>					
	8.715-342.0	1" engine shaft, 24 mm pump shaft, 139.3 oz., 2.176:1 gear ratio, 11-18 hp.			
<b>Unloader valves</b>					
	9.802-362.0	PA VBB with switch (N/C)			
	9.803-899.0	VBA35 for Kärcher KG, KD, and KE pumps			
	8.715-508.0	VBXL 13 GPM @ 3000 PSI knob			
	8.753-028.0	VR54 for Kärcher KD and KE pumps			
	9.803-900.0	VBA35 for Kärcher KM and KS pumps			
	8.753-011.0	VB56 for Kärcher KM and LS pumps			
	8.753-010.0	VB56 with 1/8" Bore for Easy Start			
	8.715-502.0	HM DX Unset (921462)			
<b>Discharge manifold / rupture disk</b>					
Coil Outlet Discharge Manifold	9.149-003.0	Prevents dangerous thermal expansion of water in the coil and ensures operator safety.			
Rupture Disk, 8000 PSI, Red	8.725-944.0				
Rupture Disk, 5000 PSI, Blue	9.151-014.0				
Rupture Disk Spacer	9.184-030.0				
<b>Safety system pistons</b>					
Magnetic Pistons (HDS units to 2005)	4.553-022.0	Used for low-water protection.			
Brass Pistons (HDS 1000 BE/DE)	4.553-213.0				
<b>Pump installation tools</b>					
To press in valve seat (5.581-143.0) on HDS 745, 945, 1000, 1055, 1195.	2.901-036.0	12 mm			
	2.901-033.0	18 mm			
	2.901-015.0	20 mm - HDS 801E, 945,1090			
	2.901-018.0	22 mm - HDS 1195			
<b>Valve seat installation tool</b>					
HDS Classic Full Size - prior 2005; to press in valve seat	5.901-126.0	(5.581-143.0) on HDS 745, 945, 1000, 1055, 1195			
HDS Classic Full Size - 2005+; to press in valve seat	5.901-162.0	(5.581-143.0) on HDS 745, 945, 1000, 1055, 1195			
<b>Valve seat removal tool</b>					
	5.901-125.0	HDS Classic Full Size			
	5.901-161.0	HDS Classic - 2012			

## AXIAL PUMPS, REPAIR KITS AND TOOLS (CONTINUED)

	Pump kit	Model part no.
<b>HD electric models</b>		
HD 1.8/13 C Ed	2.883-997.0	1.514-111.0
HD 2.3/15 C Ed	2.883-997.0	1.150-611.0
HD 3.0/20 C Ea	2.883-997.0	1.150-610.0
HD 3.0/20-4M Ea	2.884-882.0	1.524-110.0
HD 3.5/30-4S Ea	2.883-902.0	1.286-110.0
HD 3.7/22-4S Eg	2.883-902.0	1.286-115.0
HD 4.5/32-4S Eb	2.883-902.0	1.286-112.0
HD 4.5/32-4S Ec	2.883-902.0	1.286-113.0
HD 5/12 C	2.883-997.0	1.514-106.0
HD 525 S	2.883-827.0	1.118-700.0
HD 651	2.883-869.0	1.150-110.0
HD 650	2.883-869.0	1.150-106.0
HD 655 S	2.883-286.0	1.902-405.0
HD 655 H	2.883-286.0	1.902-411.0
HD 655 H	2.883-286.0	1.902-412.0
HD 750	2.880-469.0	1.625-917.0
HD 760 WS	2.880-469.0	1.797-701.0
HD 850 S	2.880-469.0	1.877-681.0
HD 850 WS	2.880-469.0	1.754-701.0
HD 855 S	2.883-817.0	1.087-701.0
HD 1090	2.883-447.0	1.951-681.0
HD 10/25 S	2.883-902.0	1.286-105.0
<b>HD gas models</b>		
HD 2.5/24 P (vers 1)	2.884-214.0	1.575-105.0
HD 2.6/26 P (vers 1)	2.884-214.0	1.575-106.0
HD 4.0/36 P (vers 1)	2.884-217.0	1.575-108.0
HD 2500 G	2.884-215.0	1.194-112.0
HD 2500 MTD	2.884-215.0	1.194-114.0
HD 2600 DK	2.884-215.0	1.194-122.0
HD 2700 DB	2.884-215.0	1.194-116.0
HD 2700 DH	2.884-215.0	1.194-117.0
HD 2700 DH	2.884-215.0	1.194-123.0
HD 2700 DH Q/C	2.884-215.0	1.194-118.0
HD 2701 DR	2.884-215.0	1.194-200.0
HD 3000 DH	2.884-216.0	1.187-116.0
HD 3101 DR	2.884-216.0	1.187-117.0
HD 3500 DB	2.884-217.0	1.810-998.0
HD 3500 DH	2.884-217.0	1.810-997.0
HD 3500 DH-Q/C	2.884-217.0	1.810-996.0
HD 3501	2.884-217.0	1.810-999.0

	Pump kit	Model part no.
<b>HD gas models (continued)</b>		
HD 3600 DH	2.884-217.0	1.180-934.0
HD 800 B	2.883-201.0	1.851-812.0
HD 830 B	2.884-214.0	1.187-103.0
HD 830 B	2.884-214.0	1.187-108.0
HD 1020 B	2.884-016.0	1.810-910.0
HD 1020 B	2.884-016.0	1.810-920.0
HD 1040 B	2.884-084.0	1.810-986.0
<b>HDS electric models</b>		
HDS 2.3/12 C Ed	2.883-891.0	1.170-606.0
HDS 2.3/13 C Ed	2.883-891.0	1.170-605.0
HDS 3.0/20 C Ea	2.883-891.0	1.170-612.0
HDS 4.0/20-4M Ea	2.885-034.0	1.071-408.0
HDS 4.5/22-4M Ea	2.885-034.0	1.071-409.0
HDS 3.5/30-4M Ea	2.885-034.0	1.071-412.0
HDS 3.5/23-4M Eg	2.885-034.0	1.071-426.0
HDS 5.0/30-4S Eb	2.885-033.0	1.071-608.0
HDS 5.0/30-4S Ec	2.885-033.0	1.071-609.0
HDS 801 E (460V)	2.883-446.0	1.030-681.0
HDS 801 E (575V)	2.883-446.0	1.030-701.0
HDS 4.0/20-4M Ea	2.883-913.0	1.027-352.0
HDS 4.5/22-4M Ea	2.883-913.0	1.027-354.0
HDS 4.5/19-4M Ea	2.883-913.0	1.027-357.0
HDS 3.5/30-4M Ea	2.883-913.0	1.027-350.0
HDS 3.5/23-4M Eg	2.883-913.0	1.027-356.0
HDS 5.0/30-4S Eb	2.883-914.0	1.028-341.0
HDS 5.0/30-4S Ec	2.883-914.0	1.028-343.0
HDS NG/LP 4.5/22 Ea ST (vers 1)	2.883-322.0	1.575-715/716.0
HDS NG/LP 4.5/22 Ea ST (vers 2)	2.883-913.0	1.575-715/716.0
HDS NG/LP 3.5/30 Ea ST (vers 1)	2.883-322.0	1.575-719/720.0
HDS NG/LP 3.5/30 Ea ST (vers 2)	2.883-913.0	1.575-719/720.0
HDS NG/LP 4.5/22 Ea ST (vers 1)	2.883-322.0	1.575-715/716.0
HDS NG/LP 4.5/22 Ea ST (vers 2)	2.883-913.0	1.575-715/716.0
HDS NG/LP 3.5/30 Ea ST (vers 1)	2.883-322.0	1.575-719/720.0
HDS NG/LP 3.5/30 Ea ST (vers 2)	2.883-913.0	1.575-719/720.0
HDS NG/LP 5.0/30 Eb ST (vers 1)	2.883-302.0	1.575-717/718.0
HDS NG/LP 5.0/30 Eb ST (vers 2)	2.883-914.0	1.575-717/718.0
HDS NG/LP 5.0/30 Ec ST (vers 1)	2.883-302.0	1.575-721/722.0
HDS NG/LP 5.0/30 Ec ST (vers 2)	2.883-914.0	1.575-721/722.0
HDS 500 Ci	2.883-459.0	1.890-406.0
HDS 501 C (vers 1)	2.883-883.0	1.272-105.0

## AXIAL PUMPS, REPAIR KITS AND TOOLS (CONTINUED)

	Pump kit	Model part no.
<b>HDS electric models (continued)</b>		
HDS 501 C (vers 2)	2.883-827.0	1.272-105.1
HDS 551 C	2.883-890.0	1.169-105.0
HDS 558 C	2.883-891.0	1.170-105.0
HDS 600 CI	2.883-922.0	1.852-407/408.0
HDS 900 Ci	2.883-855.0	1.873-408/409.0
HDS 745	2.883-322.0	1.026-911.0
HDS 745	2.883-913.0	1.026-344.0
HDS 895 M Eco	2.883-913.0	1.027-515.0
HDS 895 S VEX	2.883-913.0	1.027-304.0
HDS 945	2.883-913.0	1.027-335/336.0
HDS 945	2.883-322.0	1.027-871.0

	Pump kit	Model part no.
<b>HDS electric models (continued)</b>		
HDS 945	2.883-322.0	1.027-881.0
HDS 1000	2.883-913.0	1.027-337.0
HDS 1000	2.883-322.0	1.027-851.0
HDS 1000 A	2.880-283.0	1.718-931.0
HDS 1055	2.883-913.0	1.027-38.0/339.0
HDS 1055	2.883-322.0	1.027-81.0/691.0
HDS 1195	2.883-914.0	1.028-332.0
HDS 1195	2.883-302.0	1.028-681.0
HDS 2245 NG/LP	2.883-322.0	1.027-883/884.0
HDS 3005 NG/LP	2.883-302.0	1.028-883/884.0

## AXIAL PUMPS REPAIR KITS

	Order No.
<b>Kärcher axial pump repair kits</b>	
	2.883-997.0
	2.884-347.0
	2.883-902.0
	2.883-827.0
	2.883-869.0
	2.883-286.0
	2.880-469.0
	2.883-817.0
	2.883-447.0
	2.884-214.0
	2.884-217.0
	2.884-215.0
	2.884-216.0
	2.884-084.0

	Order No.
<b>Kärcher axial pump repair kits (continued)</b>	
	2.883-891.0
	2.885-034.0
	2.885-033.0
	2.883-446.0
	2.883-913.0
	2.883-914.0
	2.883-322.0
	2.883-302.0
	2.883-827.0
	2.883-890.0
	2.883-922.0
	2.883-855.0
	2.880-283.0

# KÄRCHER TRIPLEX PUMPS



The U-Seals provide better run-dry protection, extend pump life, and allow for inlet water of up to 145°F. Kärcher K3 pumps provide a stronger crankcase with thicker mounting feet and extra-large European made tapered roller bearings for longer pump life. The crankcase is reinforced and comes with the new O-ring seal for leak-free operation. Specially die cast connecting rods provide for quieter operation and longer pump life.



		Order no.	GPM	PSI	HP	RPM	Shaft	Description		
<b>KX series</b>										
		KX9536R.2 - Right	1	8.920-593.0	9.5	3625	23.8	1740	25 mm	The KX series pump is the patriarch of the Kärcher crankcase pump line; delivering enough volume and pressure for the beefiest of pressure washers. <ul style="list-style-type: none"> <li>• Up to 10.4 GPM and 3625 PSI</li> <li>• 40.6 oz oil crankcase capacity</li> <li>• 10% Lower RPM than comparable pumps</li> <li>• Increased ceramic thickness</li> </ul>
		KX9536L.2 - Left	2	8.920-594.0	9.5	3625	23.8	1740	25 mm	
		KX1036R.2 - Right	3	8.920-595.0	10.4	3625	25.8	1740	25 mm	
		KX1036L.2 - Left	4	8.920-596.0	10.4	3625	25.8	1740	25 mm	
<b>KX5450 series</b>										
		KX5450L - Left	5	8.921-658.0	5.4	5000	18.5	1740	24 mm	The KX5450 series of pumps provide performance up to 5.4 GPM and 5000 PSI. <ul style="list-style-type: none"> <li>• 40.6 oz oil crankcase capacity</li> <li>• 9' Water Vacuum Head</li> <li>• Oversized connecting rods</li> </ul>
		KX5450R - Right	6	8.921-657.0	5.4	5000	18.5	1740	24 mm	
<b>KT series</b>										
		KT4540L.2 - Left	7	8.921-715.0	4.5	4000	12.6	1360	25 mm	The KT series of pumps are super-duty pumps that provide the same performance as other pumps but at 10% lower RPMs. <ul style="list-style-type: none"> <li>• 40.6 oz oil crankcase capacity</li> <li>• Oversized connecting rods</li> </ul>
		KT4540R.2 - Right	8	8.921-714.0	4.5	4000	12.6	1360	25 mm	
		KT6036L.2 - Left	9	8.921-717.0	6.0	3600	15.4	1450	25 mm	
		KT6036R.2 - Right	10	8.921-716.0	6.0	3600	15.4	1450	25 mm	
<b>KM series</b>										
		KM3540R.3 - Right	11	8.751-186.0	3.5	4000	9.7	1850	24 mm	The third generation of KM pumps are designed for a broad range of applications from 3.5 - 5.6 GPM and up to 4000 PSI. <ul style="list-style-type: none"> <li>• 23.6 oz oil crankcase capacity</li> <li>• 10% lower RPM than comparable pumps</li> <li>• Heavy-duty tapered roller bearings</li> </ul>
		KM4030L.3 - Left	12	8.751-188.0	4.0	3000	8.3	1000	24 mm	
		KM4030R.3 - Right	13	8.751-187.0	4.0	3000	8.3	1000	24 mm	
		KM4035L.3 - Left	14	8.751-190.0	4.8	3500	11.6	1500	24 mm	
		KM4035R.3 - Right	15	8.751-189.0	4.8	3500	11.6	1500	24 mm	
		KM5030L.3 - Left	16	8.751-192.0	5.1	3000	10.6	1550	24 mm	
		KM5030R.3 - Right	17	8.751-191.0	5.1	3000	10.6	1550	24 mm	
		KM6035L.3 - Left	18	8.749-941.0	5.6	3500	13.5	1740	24 mm	
		KM6035R.3 - Right	19	8.749-940.0	5.6	3500	13.5	1740	24 mm	
<b>KS series</b>										
		KS3040G.3	20	8.751-193.0	3.0	4000	10.8	3400	1" hollow	The third generation of KS pumps are designed for a broad range of applications from 3.0 - 5.0 GPM and up to 4000 PSI for direct drive gas/diesel engine applications. <ul style="list-style-type: none"> <li>• 23.6 oz oil crankcase capacity</li> <li>• Durable ceramic plunger with mirror finish</li> <li>• Heavy-duty tapered roller bearings</li> </ul>
		KS3540G.3	21	8.751-194.0	3.5	4000	12.6	3400	1" hollow	
		KS4040G.3	22	8.751-195.0	4.0	4000	14.3	3400	1" hollow	
		KS5030G.3	23	8.751-196.0	5.0	3400	13.4	3400	1" hollow	
<b>KF &amp; KFP series</b>										
		KF2030F	24	8.923-790.0	2.1	3000	3.0	3450	5/8" hollow	The KF series of pumps are hollow shaft pumps designed for direct drive electric units. <ul style="list-style-type: none"> <li>• Up to 3.5 GPM and 2500 PSI</li> <li>• 14 oz oil crankcase capacity</li> <li>• Set-screw for motor shaft</li> <li>• Durable ceramic pistons with mirror finished</li> </ul>
		KFP2030S	25	8.929-254.0	2.1	3000	3.0	1725	5/8" hollow	
		KF2830S	26	8.923-793.0	2.8	3000	5.0	1725	5/8" hollow	
		KFP3530F	27	8.929-259.0	3.5	3000	6.0	3450	3/4" hollow	



# KÄRCHER TRIPLEX PUMPS



		Order no.	GPM	PSI	HP	RPM	Shaft	Description		
<b>KB series</b>										
		KBP3030R	29	8.929-255.0	3.0	3000	6.2	1650	24 mm	The Kärcher KD series of pumps are solid shaft pumps that provide superior performance when compared to similar size pumps. <ul style="list-style-type: none"> <li>• Up to 4.0 GPM and 3000 PSI</li> <li>• 14 oz oil crankcase capacity</li> <li>• Set-screw for motor shaft</li> <li>• Durable ceramic pistons with mirror finished</li> </ul>
		KB3030L.1.1	30	8.923-782.0	3.0	3000	6.2	1650	24 mm	
		KB4025R.1	31	8.923-783.0	4.0	2500	6.8	1550	24 mm	
		KB4025L.1	32	8.923-784.0	4.0	2500	6.8	1550	24 mm	
<b>KP Series</b>										
		KPP2525G	33	8.929-258.0	2.5	3500	-	3400	3/4"	The Kärcher KG series of pumps are hollow-shaft pumps available in 3/4" and 1" shaft sizes for gas engines. <ul style="list-style-type: none"> <li>• Up to 4.0 GPM and 3500 PSI</li> <li>• 14 oz oil crankcase capacity</li> <li>• Set-screw for motor shaft</li> <li>• Durable ceramic pistons with mirror finished</li> </ul>
		KPP3035G	34	8.929-256.0	3.0	3500	-	3400	3/4"	
		KPP3035G.1	35	8.929-257.0	3.0	3500	-	3400	1"	
		KP3535G.1	36	8.923-788.0	3.5	3500	-	3400	1"	
		KP4035G.1	37	8.923-789.0	4.0	3500	-	3400	1"	

# QUICK CHANGE PUMPS



Quick change pump assemblies include a pump, unloader, thermal protector, by-pass loop hose, garden hose inlet with filter, and quick connect coupler. They are easy to install, less expensive than separate components and labor to assemble components, and eliminate the guesswork on selecting components to go with the pump.



\*7-year pump warranty is for the pump only and does not include the accessories that come with the pump.

		Order no.	Type	GPM	PSI	HP	RPM	Unloader	Shaft	Description		
<b>Quick Change Pumps</b>												
		Pump Assy, KP3035G		8.924-446.0	Direct	3.0	3500	7.2	3400	VRT3	3/4" Hollow	Pump assemblies that include a pump, unloader, thermal protector, connector hose and quick coupler.
		Pump Assy, KP3535G1		8.924-447.0	Direct	3.5	3500	8.4	3400	VRT3	1" Hollow	
		Pump Assy, KS4040G.3		8.924-448.0	Direct	4.0	4000	11.0	3400	VRT3	1" Hollow	
		Pump Assy, KB3030R		8.924-449.0	Belt	3.0	3000	6.2	1650	VRT3	24mm Solid	
		Pump Assy, KM3540R.3		8.924-450.0	Belt	3.5	4000	9.6	1850	VRT3	24mm Solid	
		Pump Assy, KM3840R.3		8.924-451.0	Belt	3.8	4000	10.4	1740	VRT3	24mm Solid	

# TRIPLEX PUMP REPAIR KIT SELECTION CHART

Use the selection chart below to find the correct repair kits for the specific Kärcher pump model.

Pump model	Valves	Seal kits	Packing with brass	Plunger oil seals	Ceramic plunger kit
KX9636.2	8.753-349.0	8.752-844.0	8.757-937.0	9.802-606.0	8.752-839.0
KX1036.2	8.753-349.0	8.752-844.0	8.757-937.0	9.802-606.0	8.752-839.0
KX5450	8.753-515.0	8.753-512.0	8.757-937.0	9.802-606.0	8.753-514.0
KT4035.1	9.802-603.0	8.916-488.0	8.916-322.0	9.802-606.0	9.802-607.0
KT4040.1	9.802-603.0	8.916-488.0	8.916-322.0	9.802-606.0	9.802-607.0
KT5030.1	9.802-603.0	8.916-487.0	8.916-323.0	9.802-606.0	9.802-611.0
KT6035.1	9.802-603.0	8.916-488.0	8.916-322.0	9.802-606.0	9.802-607.0
KT4540.2	8.753-824.0	8.753-821.0	8.758-061.0	9.802-606.0	8.753-823.0
KT6036.2	8.753-824.0	8.753-821.0	8.758-061.0	9.802-606.0	8.752-823.0
KS3040.G.3	9.802-603.0	8.725-358.0	8.758-087.0	9.802-609.0	8.933-023.0
KS3540.G.3	9.802-603.0	8.725-358.0	8.758-087.0	9.802-609.0	8.933-023.0
KS4040.G.3	9.802-603.0	8.725-358.0	8.758-087.0	9.802-609.0	8.933-023.0
KS5030.G.3	9.802-603.0	8.725-358.0	8.758-087.0	9.802-609.0	8.933-023.0
KP2535G	8.754-859.0	8.754-860.0	8.758-083.0	9.803-937.0	8.754-862.0
KP3035G	8.754-859.0	8.754-860.0	8.758-083.0	9.803-937.0	8.754-862.0
KP3035G1	8.754-859.0	8.754-860.0	8.758-083.0	9.803-937.0	8.754-862.0
KP3535G1	8.754-859.0	8.754-860.0	8.758-083.0	9.803-937.0	8.754-862.0
KP4035G1	8.754-859.0	8.754-860.0	8.758-083.0	9.803-937.0	8.754-862.0
KM3540.2/3	9.802-603.0	8.725-358.0	8.758-087.0	9.802-609.0	8.933-023.0
KM4030.2/3	9.802-603.0	8.725-362.0	8.758-086.0	9.802-609.0	8.751-238.0
KM4035.2/3	9.802-603.0	8.725-360.0	8.758-085.0	9.802-609.0	8.751-237.0
KM5030.2/3	9.802-603.0	8.725-362.0	8.758-086.0	9.802-609.0	8.751-238.0
KM6035.2/3	9.802-603.0	8.725-360.0	8.758-085.0	9.802-609.0	8.751-237.0
KG2530.1	9.803-936.0	8.725-354.0	8.725-355.0	9.803-937.0	9.803-934.0
KG3030.1	9.803-936.0	8.725-354.0	8.725-355.0	9.803-937.0	9.803-934.0
KG3035.1	9.803-936.0	8.725-354.0	8.725-355.0	9.803-937.0	9.803-934.0
KG3535.1	9.803-936.0	8.725-354.0	8.725-355.0	9.803-937.0	9.803-934.0
KG4030.1	9.803-936.0	9.803-930.0	8.725-355.0	9.803-937.0	9.803-934.0
KF2030F	8.754-859.0	8.754-860.0	8.758-085.0	9.803-937.0	8.754-862.0
KF2030S	8.754-859.0	8.754-856.0	8.758-081.0	9.803-937.0	8.754-858.0
KF2830F	8.754-859.0	8.754-860.0	8.758-085.0	9.803-937.0	8.754-862.0
KF2830S	8.754-859.0	8.754-856.0	8.758-081.0	9.803-937.0	8.754-858.0
KF3530F	8.754-859.0	8.754-860.0	8.758-085.0	9.803-937.0	8.754-862.0
KE2020F.1	9.803-936.0	8.725-354.0	8.725-355.0	9.803-937.0	9.803-934.0
KE2020S.1	9.803-936.0	8.725-356.0	8.725-357.0	9.803-937.0	9.803-935.0
KE2825F.1	9.803-936.0	8.725-354.0	8.725-355.0	9.803-937.0	9.803-934.0
KE2825S.1	9.803-936.0	8.725-356.0	8.725-357.0	9.803-937.0	9.803-935.0
KE3525F.1	9.803-936.0	8.725-354.0	8.725-355.0	9.803-937.0	9.803-934.0
KD3025.1	9.803-936.0	8.725-356.0	8.725-357.0	9.803-937.0	9.803-935.0
KD3030.1	9.803-936.0	8.725-354.0	8.725-355.0	9.803-937.0	9.803-934.0
KD4020.1	9.803-936.0	8.725-356.0	8.725-357.0	9.803-937.0	9.803-935.0
KB3030	8.754-859.0	8.754-856.0	8.758-081.0	9.803-937.0	8.754-858.0
KB4025	8.754-859.0	8.754-856.0	8.758-081.0	9.803-937.0	8.754-858.0
KBP3030R	8.754-859.0	8.759-015.0	8.929-348.0	9.803-937.0	8.754-858.0
KFP2030S	8.754-859.0	8.759-015.0	8.929-348.0	9.803-937.0	8.754-858.0
KFP3530F	8.754-859.0	8.759-031.0	8.758-218.0	9.803-937.0	8.754-862.0
KPP2535G	8.754-859.0	8.759-031.0	8.758-218.0	9.803-937.0	8.754-862.0
KPP3035G	8.754-859.0	8.759-031.0	8.758-218.0	9.803-937.0	8.754-862.0
KPP3035G1	8.754-859.0	8.759-031.0	8.758-218.0	9.803-937.0	8.754-862.0

# KÄRCHER TRIPLEX PUMP REPAIR KITS



Original Factory Direct Repair Kits.

		Order no.
<b>Valve kits</b>		
Valve Kit, KM, KT, KS Series	1	9.802-603.0
Valve Kit, KX5450 Series	2	8.753-515.0
Valve Kit, KB, KP, KF Series	3	8.754-859.0
Valve Kit, KX9636, KX1036	4	8.753-349.0
Valve Kit, KE, KD, KG Series	5	9.803-936.0
Valve Kit, KBP, KFP, KPP Series	6	8.754-859.0
<b>"U" seals</b>		
Plunger Seals, 15 mm, KS Series, KM3540.2/.3	7	8.725-358.0
Plunger Seals, 18 mm KM4035.2/.3	8	8.725-360.0
Plunger Seals, 20 mm, KM4030.2/.3, KM5030.2/.3, KM6035.2/.3	9	8.725-362.0
Plunger Seals, 20 mm, KT4035.1, KT4040.1, KT6035.1	10	8.916-488.0
Plunger Seals, KX5450	11	8.753-512.0
Plunger Seals, KX9626.2, KX1036.2	12	8.752-844.0
Plunger Seals, 15 mm, KE2020F.1, KD3030.1, KG.1 Series KE2825F.1, KE3525F.1	13	8.725-354.0
Plunger Seals, 18 mm, KE2020S.1, 025.1, KD4020.1	14	8.725-356.0
Plunger Seals, KBP3030R, KFP2030S Series	15	8.759-015.0
Plunger Seals, KFP3530F, KPP Series	16	8.759-031.0
<b>Packings with brass (all packing kits with brass include U seals)</b>		
Complete Seal Packing, 15 mm, KS Series, KM3540	17	8.758-087.0
Complete Seal Packing, 15 mm, KE2020F, KD3030, KG Series KE2825F, KE3525F	18	8.725-355.0
Complete Seal Packing, 18 mm, KE2020S, KE2825S, KD Series	19	8.725-357.0
Complete Seal Packing, 18 mm, KM4025	20	8.758-085.0
Complete Seal Packing, 20 mm, KM4030, KM5030	21	8.758-086.0
Complete Seal Packing, 20 mm, KT Series	22	8.916-322.0
Complete Seal Packing, KX5450	23	8.757-939.0
Complete Seal Packing, KX9636, KX1036	24	8.757-937.0
Complete Seal Packing, KBP3030R, KFP2030S Series	25	8.929-348.0
Complete Seal Packing, KFP3530F, KPP Series	26	8.758-218.0
<b>Oil seals</b>		
Plunger Oil Seals, KT Series	27	9.802-606.0
Plunger Oil Seals, KM, KS Series	28	9.802-609.0
Plunger Oil Seals, KE, KD, KG, KB, KP, KF Series	29	9.803-937.0
Plunger Oil Seals, 22 mm, KX9636.2, KX1036.2	30	9.802-606.0
Plunger Oil Seals, KBP, KFP, KPP Series	31	9.803-937.0
<b>Ceramic plunger kit (includes bolt, washer, o-ring, teflon ring and ceramic plunger)</b>		
Plunger, 18 mm, KM3540/.3, KS.3 Series	32	8.933-023.0
Plunger, 20 mm, KM4030.2/.3, KM5030.2/.3	33	8.751-238.0
Plunger, KM6035.2/.3	34	8.751-237.0
Plunger, 20 mm, KT Series	36	9.802-607.0
Plunger, 22 mm KT5030	37	9.802-611.0
Plunger, 15 mm KS.1 Series	38	8.933-023.0
Plunger, 15 mm, KE2020F, KD2825F, KE3525, KD3030, KG Series	39	9.803-934.0
Plunger, 18 mm, KE2020S, KE2825S, KD3025, KD4020	40	9.803-935.0
Plunger, 22 mm, KX9536.2, KX1036.2	41	8.752-839.0
Plunger, KBP3030R, KFP2030S Series	42	8.754-858.0
Plunger, KFP3530F, KPP Series	43	8.754-862.0

# KÄRCHER TOOLS



A must for every Service Department. Save time using the right tool for the job.

	Order no.
<b>Kärcher pump tool kit (complete)</b>	9.802-954.0
<b>Pump repair tools</b>	
Oil Seal Bushing Inserter for KT Plunger Rod	9.802-572.0
Oil Seal Piston Inserter for KT Plunger Rod	9.802-578.0
Oil Seal Piston Inserter for KS and KS Plunger Rod	9.802-579.0
Oil Seal Bushing Inserter for KS and KS Plunger Rod	9.802-573.0
Allen Wrench, 8 mm for KT, KX, KH Manifold bolts	9.802-571.0
Allen Wrench, 6 mm for KM, KD, KG, KE, KS Manifold bolts	9.802-567.0
Allen Wrench, 5 mm for Crankcase cover bolts	9.802-570.0
Oil Seal Bushing Inserter for KT, KX, KH Crankshaft	9.802-565.0
Oil Seal Bushing Inserter for KM, KD, KG, KE, KS Crankshaft	9.802-566.0
Piston Seal Extractor	9.802-568.0
Oil Seal Inserter, Piston, KM, KD, KG, KE, KS Pumps	9.802-580.0
Oil Seal Inserter, Guide, KM, KD, KG, KE, KS Pumps	9.802-563.0
Oil Seal Inserter, Piston, KT, KX, KH Pumps	9.802-581.0
Guide, Oil Seal Inserter, KT, KX, KH Pumps	9.802-564.0
Guide, Seal Inserter, Manifold, KD, KE, KG Pumps	8.751-396.0
Guide, Seal Inserter, Manifold KX5050	8.751-404.0
Guide, Seal Inserter, Manifold, KD, KE, KG, KH, KX	8.751-397.0
Guide, Seal Inserter, Manifold, KH KX	8.751-405.0
Screwdriver, Flathead	8.751-403.0
Hammer, Plastic Head	9.802-569.0
Plastic Tool Box	9.802-574.0
Normal maintenance tool kit for KB, KP, KP1 and KF series	8.756-590.0
Oil seal maintenance tool kit for KB, KP, KP1 and KF series	8.756-717.0
<b>Misc. tools</b>	
Valve Seat Wrench	5.901-116.0
General Purpose Valve Pliers	4.901-062.0
Valve Seat Pullers - For use on deep valves	6.815-029.0
O-ring installation Tool for Classic, HD, HDS compact	5.901-090.0
O-ring Installation Tool	5.901-127.0

# KÄRCHER TOOLS

	Order no.
<b>Misc. tools (cont.)</b>	
Fan Puller	6.815-019.0
Fan Installation Tool	5.901-138.0
Fan Puller - HDS Full-size and upright - 2012	6.816-069.0
Swash Plate Removal Tool	4.901-038.0
Splash Diffuser	4.901-077.0
<b>Test gauges</b>	
Fuel Pressure Gauge	4.901-060.0
Water Temperature Gauge	3.900-003.0
Water Pressure Test Gauge	4.742-025.0
Water Temperature and Volume Gauge	2.901-030.0
Pressure Shut-off Valve	4.580-034.0
<b>Hour meter</b>	
Hour Meter - 24V / 50 mm	6.681-035.0
Hour Meter - 24V / 22 mm	6.681-012.0
<b>Kärcher pump oil</b>	
Single Phase - HD / HDS Classic 15W40	6.288-050.0
Three Phase - HD / HDS Classic 90wt	6.288-016.0
Kärcher low 40 Pump Oil	8.923-423.0
<b>Assembly grease</b>	
Silicone Grease - 5 grams	6.288-088.0
Silicone Grease - 100 grams	6.288-079.0
for Spare Parts / Pumping Kits - 5 grams	6.288-072.0
for Spare Parts / Pumping Kits - 100 grams	6.288-044.0

# COILS



Kärcher's proprietary heating coil is unequalled in the industry for its high heating performance, compact design, and super-efficiency. Double-wall construction – with air passing between the two walls – provides insulation as well as oxygen for the combustion process.

The combustion chamber and heating coil provide even heat distribution with very little condensation or corrosion and 92% + fuel efficiency to conform to the strictest air quality standards.

Combined with other Kärcher advances, our heating coil helps make Kärcher the responsible choice with the lowest cost of operation in the industry.

		Order no.	Description
<b>HDS coils</b>			
	1	4.680-080.0	HDS 1000 BE/DE
	2	4.680-081.0	HDS 4.0/30 Pe Cage; HDS 5.0/32 Pe Cage; HDS 5.5/35 Pe Cage
	3	4.680-129.0	Stainless Steel - HDS 500 Ci
	4	4.680-123.0	HDS 3.5/30-4M Ea; HDS 3.5/23-4M Eg; HDS 4.0/20-4M Ea; HDS 1055
	5	4.680-126.0	HDS 3.0/20 C Ea; HDS 501 C; HDS 551 C; HDS 558 C;
	6	4.680-126.0	HDS 2.3/12 C Ed
	7	4.680-127.0	Coil - HDS 801 B; HDS 600 Ci; HDS 900 Ci
	8	4.680-135.0	Coil - HDS 895 S (Tall)
	9	4.680-144.0	Coil - HDS Middle & Super Class (2012 Forward)
	10	4.680-147.0	Coil - HDS 1000
	11	4.680-154.0	Coil - HDS 1.7/12 U Ed
	12	9.803-135.0	Coil - HDS NG/LPG Units
	12	9.152-371.0	Coil - HDS HDS 2245/3005
<b>Stainless steel coils</b>			
	13	4.680-113.0	HDS 4.5/19-4M Eg; HDS 1195
	14	4.680-114.0	Coil, Stainless Steel - HDS 2.3/13 C Ed; HDS 745; HDS 895 S (short); HDS 945
	15	4.680-129.0	Coil, Stainless Steel - HDS 801 B; HDS 600 Ci; HDS 900 Ci
	16	4.680-130.0	Coil, Stainless Steel - HDS 3.0/20 C Ea; HDS 501 C; HDS 551 C; HDS 558 C
	17	4.680-149.0	Coil, Stainless Steel - HDS Middle & Super Class (2012 Forward)
<b>Liberty series coils</b>			
	18	8.717-928.0	Coil - HDS Heater 5.0/30 Ed
	19	8.919-133.0	Coil - HDS Gas Engine Roll Cage (Subaru); HDS Electric Roll Cage; HDS Electric Hand Truck (small)
	20	9.802-995.0	Coil - HDS Electric Hand Truck (Large)
	21	8.919-136.0	Coil - HDS Gas Engine Roll Cage (Honda); HDS Electric Hand Truck (Medium)
	22	9.803-014.0	Coil - HDS Liberty Series Skids
	23	9.803-135.0	Coil - HDS NG/LPG Units
<b>Cold rolled coils</b>			
Cold-rolled pipe, no weak points from heating to make bends. Heavy-duty schedule 80 carbon steel pipe. "Aluminized steel" wrapper. Best warranty in the industry	24	9.803-014.0	Skid Coil 20" Dia, Sch 80 with Aluminized Steel Wrap, Horizontal
	25	8.919-136.0	DuraCoil 14.5" Dia, Sch 80, HDS Cage, Roll Cage large
	26	8.919-133.0	DuraCoil 14.5" Dia, Sch 80, HDS Electric Roll Cage and Small Gas Cage
	27	9.803-135.0	NG/LPG Coil, 18" Dia

# COILS



		Order no.	Description
<b>Top and bottom wraps</b>			
	28	8.919-733.0	Coil Wrap, SS, HDS Elec Roll Cage, HDS Small Gas Roll Cage
	29	8.933-031.0	Coil Wrap, SS, HDS Electric Hand Truck, Belt Drive
	30	8.933-028.0	Coil Wrap, SS, Small HDS Electric Hand Truck
	31	8.915-908.0	Coil Wrap, SS, HDS Hand Truck, Direct Drive
	32	9.803-005.0	Top Wrap, SS, HDS Gas/Diesel Skids
	33	9.803-006.0	Bottom Wrap, SS, HDS Gas/Diesel Skids
	34	8.917-568.0	Coil Wrap, SS, NG/LPG Machines
<b>Coil insulation</b>			
Refractory grade ceramic. Retains heat inside coil for better fuel efficiency and paint protection.	35	9.802-883.0	Front Head, No Hole
	36	8.735-002.0	Front Head, No Hole, 16"
	37	9.802-894.0	Burner Head, with Hole
	38	8.731-284.0	Burner Head, with Hole, 16"
	39	8.933-009.0	Gasket, Burner Plate
	40	8.717-424.0	Gasket, Skid Stackless Top
	41	8.717-425.0	Gasket, Stackless Adapter
	42	9.802-900.0	Tank, 1" Blanket, Vertical Oil-Fired Coils
	43	9.802-901.0	Tank, 16" OD x 8" ID, Small Vertical Coils
	44	8.717-410.0	Blanket, with Foil saft (10 saft rqrtd)
	45	9.802-896.0	Blanket-No Foil, 24" x 57", Horizontal
	46	9.802-902.0	Blanket-Die Cut, 28" x 24", Horizontal
	47	8.717-433.0	Blanket-Die Cut, 33" x 89" (NG/LPG)
	48	8.930-140.0	Insulation,Tank Head, 20", 10" Opening
	49	9.802-905.0	Insulation Blanket, HDS Hand Truck
	50	8.717-433.0	Insulation Disc, HDS Hand Truck

# WAYNE BURNERS FOR KÄRCHER PRESSURE WASHERS



Kärcher's Hot Water Oil Fired Machines are now being built exclusively with Wayne Burners. Wayne Combustion has been building quality burners since 1928. They are known in the marketplace for superior reliability and ultra-high efficiency. The Wayne Burners have the following features:

- Lower Emissions
- Improved Efficiencies
- Positive flame retention
- Controlled Flame Pattern
- Low Nozzle Temperatures
- High static pressure overcomes adverse draft conditions for a better air/oil mixture.

	Order no.	Motor	Solenoid voltage	Air size	Firing rate Min (GPH)
<b>Burners</b>					
	8.756-181.0	Burner, MSR 3.75 120V 1T 120V S	120v	#6A	120v
	8.756-412.0	Burner, MSR 13.5VDC 2T 12VDC S	13.5vDC	#4A8	12vDC
	8.756-413.0	Burner, EHASR 120V 2T 120V S	120v	#4A	120v
	8.756-480.0	Burner, EHASR 12VDC DO 2T 12VDC S	12vDC	#4A	12vDC
	8.756-709.0	Burner, MSR, 230V 1T 230V S	230v	#6A	230v
	8.756-737.0	Burner EHASR 230V 1T 120V S	230v	#8A	120v
	8.756-738.0	Burner, EHASR 120VAC 1T 120V S	120v	#8A	120v
	8.756-756.0	Burner, EHASR 12VDCDO 1T 12VDC S	12vDC	#3A	12vDC
	8.756-890.0	Burner , EHASR 12VDC DO 2T 12V S	12vDC	#4A	12v



# WAYNE BURNER REPLACEMENT PARTS & CROSS REFERENCE CHART



Order no.	Description
<b>Replacement parts</b>	
8.700-822.0	FLEX COUPLING-F/307007 12V
8.700-776.0	COUPLING 5/16 x 1/2"FS
8.700-721.0	COUPLING FOR 079021X
8.756-715.0	COUPLING, "E" DC
8.756-438.0	FAN - 4.00"W X 6.25"D 1/2" BORE
8.756-660.0	Fan, 2.44" X 4.53" X 5/16" BORE
8.756-730.0	FAN, 3.44"W X 4.75"D 5/16" BORE
8.756-726.0	FAN, 3.44"W X 5.25"D 5/16" BORE
8.700-730.0	BLOWER WHEEL, 5-.25' x 3-7/16(307000)
8.700-728.0	BLOWERWHEEL EG1/MSR3.44x4.25STAR MET MTR
8.700-760.0	FUEL PUMP, SUNTEC A2VA-3106 230V SOL
8.756-290.0	FUEL PUMP, WCS - COMBO/W SOLENOID 120V
8.756-437.0	PUMP - COMBO/W SOLENOID 12V/24V
9.107-507.0	IGNITOR
8.700-803.0	IGNITOR, 120V, BACK/M-MSR MOUNT
8.700-802.0	IGNITOR, 120V, SIDE/EH-EHA MOUNT
8.756-291.0	IGNITOR, BURNER, "E" 240 50-60
8.756-324.0	IGNITOR, BURNER, "M" 240 50-60
8.756-436.0	MOTOR, 1/4 120V 50-60HZ
8.756-716.0	MOTOR, 1/4 13.5VDC AMETEK
8.717-830.0	MOTOR, 1/8HP 1PH 230V 3450RPM
8.756-293.0	MOTOR, BURNER, 1/5 120V 50-60HZ
8.756-294.0	MOTOR, BURNER, 1/5 230V 50-60HZ
8.756-292.0	MOTOR, BURNER, 1/7 HP 120/60
8.700-739.0	BURNER MOT 12V-WH MSR DC FASCO

Wayne Burner Order no.	Description	Fuel Pump	Ignitor	Burner Motor	Burner Fan	Coupling
<b>Replacement part cross reference chart</b>						
8.756-181.0	Burner, MSR 3.75 120V 1T 120V S	8.756-290.0	8.700-803.0	8.756-292.0	8.700-728.0	8.700-822.0
8.756-412.0	Burner, MSR 13.5VDC 2T 12VDC S	8.756-437.0	9.107-507.0	8.700-739.0	8.756-660.0	8.700-721.0
8.756-413.0	Burner, EHASR 120V 2T 120V S	8.700-760.0	8.700-802.0	8.756-436.0	8.756-438.0	8.700-776.0
8.756-480.0	Burner, EHASR 12VDC DO 2T 12VDC S	8.756-437.0	9.107-507.0	8.756-716.0	8.756-726.0	8.756-715.0
8.756-709.0	Burner, MSR, 230V 1T 230V S	8.700-760.0	8.756-324.0	8.717-830.0	8.700-728.0	8.700-822.0
8.756-737.0	Burner EHASR 230V 1T 120V S	8.756-290.0	8.756-291.0	8.756-294.0	8.700-730.0	8.700-776.0
8.756-738.0	Burner, EHASR 120VAC 1T 120V S	8.756-290.0	8.700-802.0	8.756-293.0	8.700-730.0	8.700-776.0
8.756-756.0	Burner, EHASR 12VDCDO 1T 12VDC S	8.756-437.0	9.107-507.0	8.756-716.0	8.756-730.0	8.756-715.0
8.756-890.0	Burner , EHASR 12VDC DO 2T 12V S	8.756-437.0	9.107-507.0	8.756-716.0	8.756-726.0	8.756-715.0

## SURFACE CLEANERS

### SURFACE CLEANERS - A+ - 21" & 24"

Fast, even cleaning for large flat surfaces. Quickly cleans concrete, asphalt, and it removes grime and deposits from tennis courts, ramps and decks. Also great for factory and semi-trailer floors and drive-thrus. Cleans better and faster than a spray wand alone, with no striping. Use with hot or cold water and handles water up to 212°F to disinfect bathrooms and kitchens. Safety lock prevents accidental spraying.

- Two Spinning Nozzles 'Floats' Cleaner Above the Ground
- Circular Design for Zero Wall Clearance
- Stainless-steel Housing and Handle
- Universal Inlet Fitting Kit to Accommodate All Common Configurations
- Reduces Overspray on Walls, Landscaping and Operator
- Two #2.0, 1/8" Nozzles (for machines up to #4.0 nozzles), 25° Nozzles Rated up to 8.0 GPM and 4000 PSI
- Requires at Least 3.0 GPM, 2000 PSI



PART NO.	DESCRIPTION
8.753-572.0	A+SC21 Rotary Surface Cleaner, 21"
8.753-573.0	A+SC24 Rotary Surface Cleaner, 24"
8.753-597.0	Swivel for 21" and 24"
8.921-834.0	Spray Gun Kit for A+SC 21 & A+SC24 Includes: Screw M6X30, ¼" Quick Connect, Sleeve, Trigger Gun
8.921-845.0	Caster Kit for A+SC 21 & A+SC24 Includes: Nut M6, Caster Spacer, Caster Wheel

### SURFACE CLEANERS - VAC RECOVERY

- PSI: 4000 PSI
- GPM: 10.5
- Temperature: 210°F
- 1/4 " 2.5 Nozzle
- Universal Inlet Fitting Kit to Accommodate All Common Configurations
- Water Recovery with use of vacuum



PART NO.	DESCRIPTION
9.113-972.0	Vac Recovery Surface Cleaner

### A+ 24" VENTURI PUMP SURFACE CLEANER

The classic 24" A+ Surface Cleaner with the added Venturi pump water recovery system and a 16' water recovery hose that allows you to recover water without the need of a vacuum unit. Effectively transfers water and small debris (smaller than 3mm) to a drain or tank.

- Stainless-steel Housing and Handle
- Universal Inlet Fitting Kit to Accommodate All Common Configurations
- Two #2.0, 1/8" Nozzles (for machines up to #4.0 nozzles), 25° Nozzles Rated up to 8.0 GPM and 4000 PSI
- Requires at Least 3.0 GPM, 2000 PSI



PART NO.	DESCRIPTION
9.116-064.0	Vac Recovery Surface Cleaner

**LOWER PRICE** **SURFACE CLEANERS - GP - FLAT 12", 18" & 20"**

**DFSCP12 HANDHELD SURFACE CLEANER**

- PSI: 3500
- GPM: 6.5
- Temperature: 180°F
- Inlet M22 Male



**DCFSCP SURFACE CLEANER, 18" AND 20"**

- PSI: 4000
- GPM: 8.0
- Temperature: 180°F
- Inlet 3/8" FPT
- Includes 1/4" 2.0 Nozzle



PART NO.	DESCRIPTON
9.112-957.0	DFSCP12 GP Surface Cleaner, 12" 3500 PSI Handheld Flat ABS, Complete Assembly
9.112-958.0	DCFSCP18GZ GP Surface Cleaner, 18" 4000 PSI Brush Skirt ABS, 2-Arm, Zerk Fitting, Compensating Gun
9.112-959.0	DCFSCP20GZ GP Surface Cleaner, 20" 4000 PSI Brush Skirt ABS, 2-Arm, Zerk Fitting, Compensating Gun
REPAIR KITS FOR DCFSCP	
9.112-960.0	Trigger Gun Replacement
9.112-961.0	Spraybar 20" with Nozzles (for DCFSCP20)
9.112-962.0	Spraybar 18" with Nozzles (for DCFSCP18)
9.112-963.0	Swivel, Greaseable (for DCFSCP)
9.112-964.0	Swivel Repair Kit, Greaseable (for DCFSCP)

**SURFACE CLEANERS - ECONOMY - 8" & 15"**

- PSI: 4000
- Min: 2 GPM
- Max: 10.5 GPM
- Temperature: 180°F
- Includes 2 1/4 Size 2.5 Nozzle
- 15" Surface Cleaner: 1/4 QC Male Plug Inlet
- 8" Surface Cleaner: 1/4 FPT



9.112-967.0



9.112-968.0

PART NO.	DESCRIPTON
9.112-967.0	15" Surface Cleaner with Wheels
9.112-968.0	8" Stainless-steel Surface Cleaner with Handle
REPAIR KITS	
9.113-078.0	Swivel (for 9.112-967.0)
9.113-080.0	Swivel (for 9.112-968.0)
9.113-079.0	Spraybar (for 9.112-967.0)
9.113-081.0	Spraybar (for 9.112-968.0)
9.113-097.0	Caster Wheel (for 9.112-967.0)
9.113-732.0	Brush, 8" ( for 9.112-968.0)

**SURFACE CLEANERS - WHISPER WASH FLAT**

**THE "MAXIMA 36"**

- PSI: 2000 - 4000
- GPM: 4-10
- Temperature: 212°F
- RPM: 2500
- Portable Breakaway Handle
- Uses 1/4" Nozzle
- Dimensions: 36" Cover, 77" Handle
- Weight: 37 lbs.



**THE "BIG GUY"**

- PSI: 2000 - 4000
- GPM: 4.0 - 10.0
- Temperature: 212°F
- Powder-Coated Aluminum Housing
- Oversized, Self-lubricating Twin Thrust Bearings
- 10" Pneumatic Tires, 4" Caster
- Crafted with Durable Stainless-steel and Aircraft Aluminum
- Uses 1/4" Nozzle
- Choice of 2 or 4 Nozzles
- Dimensions: 28" x 44" x 12"



PART NO.	DESCRIPTION
8.710-089.0	Maxima 36
8.710-074.0	Whisper Wash Big Guy 2 Nozzles
8.710-075.0	Whisper Wash Big Guy 4 Nozzles
9.109-608.0	Surface Cleaner In-Line Water Filter for Handle
<b>REPAIR KITS</b>	
8.750-604.0	Swivel, Complete Big Guy and Classic
8.701-879.0	Repair Kit, Seal, Big Guy and Classic
8.701-874.0	Spraybar, 4 Nozzle, Big Guy
8.701-876.0	Spraybar, 2 Nozzle, Big Guy
8.701-882.0	Seal Kit: Ultra Clean
8.701-883.0	Complete Swivel Kit: Ultra Clean
8.750-604.0	Complete Swivel Kit: New Style
8.707-653.0	2.5 x 25° 1/4" Nozzle Fits All

**SURFACE CLEANER NOZZLE RECOMMENDATION**

Determine the correct nozzle size for the pressure washer being used with the surface cleaner. Never use a smaller size nozzle as this will wear out the unloader valve on the pressure washer prematurely. The Legacy Undercarriage Cleaner and A+ Surface Cleaners come with nozzles; for other surface cleaners, nozzles must be purchased separately. Threaded nozzles are listed on pages page 193-197 of the catalog, to determine your pressure washer nozzle size refer to chart on page 190. Contact us for additional sizes for surface cleaner spray bars which use four nozzles.

PRESSURE WASHER NOZZLE SIZE	QUANTITY NEEDED	1/8" OR 1/4" MPT
#3.5 and #4.0	2 each	#2.0
#4.5 and #5.0	2 each	#2.5
#5.5 and #6.0	2 each	#3.0
#6.5 and #7.0	2 each	#3.5
#7.5 and #8.0	2 each	#4.0

**UNDERCARRIAGE CLEANER**

No more crawling under a vehicle. Effortlessly wash away damaging debris from the bottom of your vehicle with the easy to handle and maneuver Legacy Undercarriage Cleaner. Simply connect to your hot or cold water pressure washer to remove road grime, fuel and oil contaminants, snow sludge, and ice. The stainless-steel rotating nozzle assembly requires a 5.5" under vehicle clearance.

- PSI: 4000
- GPM: 10.5
- Temperature: 250°F
- Four Nozzles:
  - (2) 0° #2.0
  - (2) 25° #2.0



PART NO.	DESCRIPTION
8.749-303.0	Undercarriage Cleaner

## UNDERCARRIAGE CLEANER & ROOF SURFACE CLEANER

### UNDERCARRIAGE CLEANER

- PSI: 4000 PSI
- GPM: 10.5
- Temperature: 210°F
- 1/4 " 2.5 Nozzle
- Universal Inlet Fitting Kit to Accommodate All Common Configurations
- 17cm Plate Height
- 26 lbs.



### ROOF SURFACE CLEANER

- PSI: 4000 PSI
- GPM: 10.5
- Temperature: 210°F
- 1/4 " 2.5 Nozzle
- 3/8" QC Socket
- 22 lbs.



PART NO.	DESCRIPTION
9.112-965.0	Undercarriage Cleaner, 20" Stainless-steel
9.112-966.0	Roof Surface Cleaner, 20" ABS
<b>REPAIR KITS</b>	
9.113-083.0	Replacement Gun (for Undercarriage Cleaner)
9.113-074.0	Swivel (for Undercarriage Cleaner)
9.113-076.0	Swivel (for Roof Surface Cleaner)
9.113-075.0	Spraybar (for Undercarriage Cleaner)
9.113-077.0	Spraybar (for Roof Surface Cleaner)
9.113-096.0	Caster Wheels 1.5" (for Undercarriage Cleaner)
9.113-095.0	Caster Wheels 3" (for Undercarriage Cleaner)
9.113-094.0	Caster Wheels 5" (for Roof Surface Cleaner)

## WATER BROOM 16"

- PSI: 4000
- GPM: 8.0
- Temperature: 250°F
- Includes 1/4" Plug and 4 Nozzles (pre-installed)- PN# 9.106-054.0
- Requires Wand (sold separately)



PART NO.	DESCRIPTION
8.710-082.0	Water Broom 16"

## CURB CLEANER

- PSI: 4000
- Adjustable Height 5'-9"
- 3 Side Nozzles
- 1 Top Nozzle



PART NO.	DESCRIPTION
9.115-327.0	Curb Cleaner
9.116-397.0	Replacement Nozzle

## NEW OFFERING 21" UNDERCARRIAGE CLEANER KIT

- 4 GPM
- 36" 2 Piece extension wand swivel caster included
- "1/4" Plug inlet
- 212 degree temp max



PART NO.	DESCRIPTION
9.116-556.0	Underbody Waterbroom Combo - 21"

**UNDERBODY WAND ASSEMBLY - SELF SERVE**



Ideal for rinsing the undercarriage of cars and trucks. Connect directly to a pressure washer. The lightweight underbody wand assembly rolls easily, giving the operator a longer reach.

- PSI: 3000
- Temperature: 300°F
- Inlet/Outlet: 1/4" M x F
- Non-weeping
- Stainless Steel
- ST-601 Inline Trigger Gun & Three 25°, #2, 1/8" MEG Nozzles (included)



PART NO.	DESCRIPTION
8.755-257.0	Self Serve Underbody Wand Assembly

**NEW OFFERING UNDERCARRIAGE CLEANER**



- PSI: 4000
- 1/4" QC Plug Inlet



PART NO.	DESCRIPTION
9.114-996.0	Undercarriage Cleaner

**DUCT CLEANER**

- PSI: 4000
- 10.5 GPM



PART NO.	DESCRIPTION
9.115-324.0	Adjustable 6"
9.115-325.0	Fixed 6"
9.115-326.0	Adjustable 3"
9.116-398.0	Replacement Nozzle 1/8" for adjustable 1/8"
9.116-399.0	Replacement Nozzle 1/8" for fixed 1/4"
9.116-400.0	Replacement Swivel for 3' and 6"

**DUCT CLEANER**



**DUCT CLEANER**

Designed as an accessory for use with high-pressure pumps or pressure washers. Cleans ducts, chutes, vents, restaurant exhausts, tanks, etc.

Self-rotating and feeding stainless-steel triple bearing system for constant easy turning. Nozzle holders are 1/8" NPTF. Nozzles are sold separately.



- PSI: 4000
- Temperature: 250°F
- Inlet Ports 3/8" NPTF
- Weight: 2 lbs.

**12" SURFACE CLEANER**

Designed for effortless cleaning of small areas, including walls and angled surfaces. High RPM swivel with integrated toggle joint and adjustable tension system.

- PSI: 4000
- Temperature: 250°F
- Weight: 9 lbs.
- 12" Stainless-Steel
- Includes All Items Pictured



PART NO.	DESCRIPTION	PSI
8.712-280.0	Duct Cleaner TXR-2s, Adjustable	4000
8.712-279.0	Duct Cleaner TXR-2s, Fixed	4000
8.749-911.0	Surface Cleaner, 12"	4000
8.712-285.0	Toggle Joint KGK	4000

**SANDBLAST KIT - TUNGSTEN CARBIDE NOZZLE HEAD - INDUSTRIAL**

A Venturi orifice creates a uniform blast pattern, doubles sand velocity and produces up to 45% more work with 20% less sand.



- PSI: 1500 - 5500
- GPM: 3.0 - 10.0
- Temperature: 200°F
- Weight: 10 lbs.
- Nozzle Tip (sold separately)

PART NO.	DESCRIPTION
8.701-485.0	Industrial Sand Blast Kit
8.725-620.0	Replacement Carbide Nozzle

## SANDBLASTERS - INDUSTRIAL

For the extra-tough cleaning jobs, wet-sandblasting is the dust-free solution. The sandblasters attach to a hot or cold water pressure washer and, using a venturi, mixes sand or other abrasive media with the high-pressure spray to create enough cleaning power to strip paint off concrete and barnacles from a ship's hull. The sandblasting nozzle is made of tungsten carbide for long life. There are two models—a top-of-the-line steel pot with tight-fitting lid or with a probe only.

- Quick-connect coupler for ease in attaching sand probe or pot
- Valve for metering the flow of the media
- Tubed, pneumatic tires for easy maneuvering
- Rating: Super-duty
- Recommended Usage: Heavy
- Attach to any hot or cold water pressure washer with minimum volume of 4 GPM



8.904-472.0

PART NO.	DESCRIPTION
8.904-470.0	Sandblaster with Pot (Carbide)
8.904-472.0	Sandblaster with Probe (Carbide)

NOTE: Excluded from any dealer freight programs



8.904-470.0

## SANDBLAST HEAD - PROFESSIONAL

- PSI: 3500
- GPM: 10.0
- Temperature: 200°F
- Long-Wearing Carbide Sand Nozzle
- Sand Probe Weight: 6oz..
- 1/4" FPT Water Inlet
- Head Weight: 13oz..
- Length: 16"



PART NO.	DESCRIPTION	NOZZLE SIZE
8.711-242.0	Sandblast Head	3.5
8.711-243.0	Sandblast Head	4.0
8.711-244.0	Sandblast Head	4.5
8.904-403.0	Sandblast Head	5.0
8.711-245.0	Sandblast Head	5.5
8.904-404.0	Sandblast Head	6.0
8.711-247.0	Sand Probe	
8.901-264.0	1/2" ID Polybraided Tubing, 25'	

## SAND NOZZLE

Tungsten Carbide provides maximum durability for sandblasting application.



- Carbide insert
- Light weight
- Easily changed-30°F to 130°F

PART NO.	DESCRIPTION
8.712-416.0	Carbide Sand Nozzle

## SANDBLAST HOSE

Heavy-duty spiralite hose available preassembled or by the foot.



- 3/4" spiralite sand hose with air hose locking couplers
- Temperature: -30°F to 130°F

PART NO.	DESCRIPTION	SIZE
8.711-809.0	Sand, Spiralite /ft	3/4"
8.711-839.0	Assy, Sand, Spiralite	3/4" x 25'
8.711-840.0	Assy, Sand, Spiralite	3/4" x 40'
8.711-811.0	Sand, Spiralite /ft	1"

## SANDBLAST NOZZLE TIPS



- Replacement Tips for Sandblaster Kit
- Use 1/4" Meg 5" Spray Tip

PART NO.	DESCRIPTION
8.707-668.0	4.0 x 5° Tip
8.707-685.0	5.0 x 5° Tip
8.707-696.0	5.5 x 5° Tip
8.707-701.0	6.0 x 5° Tip
8.707-709.0	6.5 x 5° Tip

**STEAM LANCE**

Completely insulated for maximum protection.

- Lance with steam nozzle shown
- Vented grip full length of lance



PART NO.	DESCRIPTION
8.904-444.0	48" with Steam Nozzle
8.904-441.0	48" without Steam Nozzle

**FOOT-CONTROLLED PRESSURE VALVE**

Operators of sewer and tube cleaning equipment need both hands free to feed or retract the hose in the sewer line. Foot-operated valve allows hands-free control.



- |   |   |
|---|---|
| <p><b>8.710-134.0</b></p> <ul style="list-style-type: none"> <li>■ PSI: Up to 5000</li> <li>■ GPM: 12.0</li> <li>■ Inlet 3/8", Outlet 1/4"</li> </ul> | <p><b>8.709-972.0</b></p> <ul style="list-style-type: none"> <li>■ Brass Body</li> <li>■ Stainless-steel Valve</li> </ul> |
|---|---|

PART NO.	DESCRIPTION	PSI
8.710-134.0	Sewer Cleaner Foot Valve	3000
8.709-972.0	Foot Valve with ST-2305	5000
8.701-657.0	Repair Kit - Foot Valve	
8.701-673.0	Repair Kit ST-2305	
8.711-526.0	Kit, 25' Hose, #4.5 Nozzle, Foot Valve	

\*Heavy gauge steel construction for durability and stability

**SLUDGE SUCKER - ST-36 PIT BOSS**

Sludge Sucker uses a high-pressure water stream at 1000-3000 PSI to suck the sludge off the bottom of pits or tanks and eject it through a 1-1/2" diameter 15' long hose to a disposal tank.

The base unit attaches to the end of a pressure washer lance with a quick coupler for extension to the bottom of the pit. Uses a 0° tip for suction / power ejection.



- Easy to change for different plumbing system flows and pressures
- Uses Standard 1/4" MPT Nozzle

PART NO.	DESCRIPTION
8.711-112.0	ST-35 Pit Boss, 5.5 Nozzle, 15' Hose
8.711-110.0	Base Unit Only

\*without Hose, Nozzle or Quick Coupler (3/8" Inlet Port)

**DRUM PUMPS - RED HEAD**

Siphon liquids from higher to lower levels. Simply pump the bellows a few times to prime and start flow. Loosen air lock to stop.

- Drum Pump fits 15-, 30- and 55- Gallon Drums
- Fit 2" Bung Opening
- Excellent for Alkaline and Acidic Chemicals, Diesel Fuel and Oils
- Not for Use with Solvents



PART NO.	DESCRIPTION
8.704-698.0	Red Hex Head, Heavy-duty
8.704-696.0	Red Head, Standard-duty
8.704-694.0	Pail Pump, 5 Gallon

**DRUM / TANK PUMP - CRANK STYLE**

Chemical-resistant, lightweight pump, ideal for dispensing chemicals, pesticides and oils. Polypropylene for most alkalis, dilute acids, pesticides and most oils and solvents. Ryton for extremely aggressive acids, aromatic and aliphatic hydrocarbons.



- 11 oz. Per Revolution
- 6.0 GPM at 70 RPM
- Viton Seals
- Polypropylene Gasket
- Outlet 3/4" Barb Two-piece
- 2" Bung Adapter
- 47" Suction Tube
- Weight: 2.6 lbs.

PART NO.	DESCRIPTION
8.704-700.0	Polypropylene Pump, Standard
8.704-701.0	Ryton Pump, Deluxe
8.700-526.0	Replacement Handles

**DRUM PUMPS - TOOLS / ACCESSORIES**

The indispensable tools.



PART NO.	DESCRIPTION
8.712-534.0	Drum Plug Wrench
8.704-689.0	Lid-Off
8.704-691.0	Funnel, 7" x 10"
8.704-692.0	3/4" Faucet
8.704-693.0	2" Faucet



## BRUSHES



Rotating brush, natural bristle (soft) used for painted surfaces. Nylon bristle (stiff) used for removing scum and grime on fiberglass boats, etc.



- Internal Nozzle: Size 20
- GPM: 8.0

PART NO.	DESCRIPTION
<b>BRUSH UNIT COMPLETE</b>	
8.709-312.0	Natural
8.709-314.0	Nylon
<b>REPLACEMENT BRUSHES</b>	
8.709-313.0	Natural
8.709-316.0	Nylon



**Truck/Tractor Wash Brush**

- Flag-Tipped
- Soft Bristle
- Acme Thread for Super Handles or Broom Handles

8.709-298.0

PART NO.	DESCRIPTION
8.709-298.0	2-1/2" Bristle with Bumper x 10"
8.709-303.0	2-1/2" Bristle x 18"
8.709-304.0	2-1/2" Bristle x 24"
8.709-305.0	60" Flow Thru Lance*

\*With Acme Thread and Garden Hose Attachment



**Deck Scrub Brush - Over / Under**

- Not a Flow Thru
- Excellent Chemical Resistance
- Use with Threaded Handle
- Trimmed for Cleaning Hard-to-reach Areas
- Stiff Polypropylene Bristle for Aggressive Cleaning
- Unique Heavy-duty Scrub Brush with Multi-level Angle
- 10" Molded Polypropylene Foam Block does not Warp or Absorb Water

PART NO.	DESCRIPTION
8.709-302.0	Deck Scrub Brush

## HANDLES - FIBERGLASS "SUPER HANDLES"



- Tough, Durable, Lightweight
- No Cracking, Splintering
- No Kinks, Dents
- Safer Around Electrical Hazards
- Super Heavy-duty Aluminum Alloy Threads
- Easy-twist Cam Lock Extension
- Standard 3/4" Acme Thread Fits: Brooms, Brushes, Utility Tools
- Optional Reduction Adapter for 3/4" to Acme Standard

PART NO.	DESCRIPTION
<b>SUPER HANDLES</b>	
8.709-306.0	48" Length (4')
8.709-307.0	60" Length (5')
8.709-308.0	72" Length (6')
<b>SUPER-EXTENSION HANDLES</b>	
8.709-309.0	4' to 8' Extension
8.709-310.0	6' to 12' Extension
8.709-311.0	8' to 16' Extension
8.700-308.0	Threaded Adapter

## FOAMERS - FOAM CANNON

The ideal Foam Generator Application Accessory meters the foaming chemical for customized foam type and applies the foam to match the application.



- PSI Max: 3000
- GPM Max: 4.8
- Temperature: 140°F
- Brass Meter Valve
- High-impact, Glass Filled Body
- Stainless-steel Foam Turbulator
- 1/4" FPT Lance Connect
- Stainless-steel 1.5mm Orifice (#5.5 nozzle equivalent)

PART NO.	DESCRIPTION
8.710-125.0	Foam Cannon / Injector
8.710-126.0	Foam Cannon / Injector / Bottle
8.704-222.0	Replacement Turbulator Screen
8.749-826.0	Replacement Bottle

**FOAMERS - PF22 MTM HYDRO FOAM CANNON**



- PSI Max: 5000
- GPM Max: 5.3
- Temperature: 140°F
- Inlet: 1/4" Q.C. Plug
- 1/4" M22 Adapter (Included)
- 1/4" x 9" Tube for Drawing Chemical
- 3.5 Orifice (1.25 mm) (installed in the foamer body)
- 3.0 orifice (1.1 mm) (included)

PART NO.	DESCRIPTION
8.758-981.0	PF22.2 MTM Hydro Foam Cannon
9.112-494.0	PF22 3pk Replacement Bottle W/Cap
9.112-945.0	PF22 5pk Replacement Bottle W/Cap

**FOAMERS - SUTTNER ST-75/76 KITS**



Clean with foam and save time as well as use half the chemical. Many sizes and variations available. Ask us for additional size options. Foam injector conveniently attaches after the pump and unloader on your pressure washer.



- ST-75 FOAM NOZZLE**
- PSI: 4000
  - Inlet 1/4"
  - Weight: .31 lbs.



- ST-76 FOAM NOZZLE**
- PSI: 3625
  - Inlet: 1/2"
  - Weight: 1.15 lbs.



- ST-160 INJECTOR**
- PSI: 5000
  - Stainless-steel Housing
  - Single Chemical
  - Inlet/Outlet: 3/8" F x M
  - Weight: .71 lbs.

PART NO.	DESCRIPTION	ORIFICE
9.113-063.0	Kit 1: ST-75 Nozzle & ST160 Injector	2.0-3.5 342
9.113-064.0	Kit 2: ST-75 Nozzle & ST160 Injector	4.0-5.5
9.113-065.0	Kit 3: ST-75 Nozzle & ST160 Injector	6.5-7.0
9.113-066.0	Kit 4: ST-76 Nozzle & ST160 Injector	7.5-8.5
9.113-067.0	Kit 5: ST-76 Nozzle & ST160 Injector	9.0-12.0

**FOAMERS - LEGACY COMPACT**



Generates a high-density clinging foam for extended dwell-time to increase chemical action.



- PSI: 2500
- GPM: 1.0 to 5.0
- Temperature: 195°F
- Stainless-steel, Aluminum and Brass
- 5" Long, 1" Diameter
- 4 and 6.5 Nozzle Included

PART NO.	DESCRIPTION
8.903-998.0	1/8" F Inlet
8.903-999.0	1/4" F Inlet

Note: Most cleaning chemicals perform best when applied at 120° - 150°F and can be applied as a foam by adding a foaming agent. See your chemical supplier to obtain the correct product.

**NEW OFFERING** **FOAM CANNON - ADJUSTABLE PATTERN 2L**



- 2 Liter
- Legacy Horizontal and Vertical Adjustable Pattern

PART NO.	DESCRIPTION
9.114-849.0	1/4" QC Plug inlet

**NEW OFFERING** **FOAM CANNON - WIDE MOUTH 1.5L**



- Wide Mouth 1.5 Liter
- A+ 1/4" QC Plug Inlet

PART NO.	DESCRIPTION
9.114-850.0	1/4" QC Inlet

### FOAMERS - LAFFERTY AIRLESS 10/20 SS



- Machined Stainless-steel Construction
- Stainless-steel Chemical Check Valve & Quick Disconnects
- Temperature: 180°F Max
- Chemical Tube with Strainer: 10SS: 6" & 20SS - 10"
- Color-coded Metering Tips for up to 21 Dilution Ratios
- 0° nozzle for Increased Foam-throw Distance

PART NO.	DESCRIPTION	FLOW RATE @ 2000 PSI
8.749-908.0	10SS Combo	4.0 GPM
8.749-909.0	20SS Hose End	6.0 GPM

### FOAMERS - FOAM JET KIT

Long-distance foam applicator. Shoots over 20 feet of dense foam. Suction at 30 feet of height. Variable spray pattern.



- PSI: 5000
- GPM: 5.6
- Temperature: 140°F
- 1/4" Inlet
- 33' Tube

PART NO.	DESCRIPTION
8.750-296.0*	Foam Jet Kit, 5000 PSI, 5.6 GPM
8.750-429.0	Foam Repair Kit, O-Rings/ Stainless-Steel Filter
8.750-430.0	Foam Jet Repair Kit, Hose, Valve & Filter

\*Includes tubing and fittings as shown

### FOAMERS - ADJUSTABLE WITH TANK

Control the foam spray angle with the variable fan nozzle.



- PSI: 2600
- GPM: 5.3
- Temperature: 140°F
- Horizontal Variable Fan Nozzle
- Foam Control Adjustment Knob

PART NO.	DESCRIPTION
8.710-124.0	Adjustable Foamer with Tank

### SPRAYERS - B&G POLY-MOLDED

3-gallon poly-molded sprayer with maximum chemical resistance.



- Heavy-Duty Design, Economical Price
- Blue Poly-Molded Tank
- Funnel Top Design for Ease-of-filling
- Braided, Reinforced Hose
- Durable Plastic Valve and Extension
- Pin-to-cone Spray Tip Fully Repairable
- Optional Flat-Fan Spray Tips
- Buna Gaskets and Seals

PART NO.	DESCRIPTION
8.697-172.0	Poly-molded Sprayer

### SPRAYERS - CHAPIN AIR-POWERED



- Pump-up Style
- Heavy-duty Plastic Sprayers for Chemical Applications
- Adjustable Nozzle - Mist to Solid Stream
- 2-Gallon Sprayer has 2' Hose and Hand Trigger
- Excellent Chemical Resistance
- Locking Hand Pump Handle Serves as Carrying Handle

PART NO.	DESCRIPTION
8.704-703.0	Thumb Button 3 Pint
8.704-702.0	2-Gallon Sprayer

## PRESSURE WASHER ACCESSORIES

### DISINFECTANT - VITAL OXIDE

Vital Oxide is an EPA registered disinfectant and sanitizer with the following key attributes: Disinfection, Sanitizing, Odor Elimination, Eliminates SARS-CoV-2 (COVID-19), Carpet Sanitization, Allergen Removal, Kills Mold and Mildew, Parvo, Distemper, Tuberculous. Sanitizer dilution is NSF approved as a no rinse sanitizer for non-porous food contact surfaces. (US Only).



- pH: 8.0 - 9.0
- Color: Clear
- Scent: None
- Dilution: Disinfection: RTU  
Carpet Sanitizing: 1 : 5  
Sanitizing: 1 : 9
- Foam (1-5): 2
- Phosphate Free

PART NO.	DESCRIPTION
8.639-560.0	Vital Oxide, 6 x 32 oz
8.639-558.0	Vital Oxide, 4 x 1 gal
8.644-292.0	Vital Oxide, 5 gal
8.642-823.0	Vital Oxide, 15 gal
8.698-112.0	Vital Oxide, 55 gal

### RAIN SUIT, 2 PIECE



- Heavy-duty, 2-ply Laminated Vinyl (25 mil)
- Jacket and Pants
- Bright Safety Yellow
- Vented for Air Flow

PART NO.	DESCRIPTION
8.704-666.0	Large
8.704-667.0	Extra Large

### TAPE - TEFLON® THREAD SEALING



- Big 1/2" x 520" Roll
- Mil - Spec #T27730

PART NO.	DESCRIPTION
8.704-705.0	Thread Sealing Tape

## THREAD LOCK PRODUCTS



- Direct Replacement for Loctite® & Fel-Pro™ Products
- Excellent Lubricant
- Prevents Corrosion and Fretting
- NDTM Anaerobic Adhesives: Liquid Materials that Cure to a Solid, Chemical-resistant Plastic State when Air is Not Present

PART NO.	DESCRIPTION	LOCTITE® EQUIV	BOTTLE SIZE
8.704-644.0	Nut Grade™	242	10 ml
8.704-645.0	Nut Grade™	242	50 ml
8.704-646.0	Nut Grade™	242	250 ml
8.704-648.0	Stud Grade™	271	10 ml
8.704-649.0	Stud Grade™	271	50 ml
8.704-650.0	Penetrating Adhesive (Sealant)	290	10 ml

Nut Grade™ & Stud Grade™ are trademarks of the Oakland Corp. Loctite® is a registered trademark for the Loctite® Corp.

## GLOVES - INDUSTRIAL DUTY

Industrial-grade gloves for most industry-needs – chemical, heat, abrasion protection.



### BLACK PVC GLOVE

- 14" PVC Glove
- Lined with Cotton
- Good for Chemical Handling
- Resists alkalines, Acids
- Great as Sandblasting Gloves

PART NO.	DESCRIPTION
8.704-669.0	Black PVC Glove

## HAND CLEANER - VICTOR WATERLESS COMMAND-O WITH PUMICE

A unique blend of natural citrus extract (limonene), aloe vera, glycerine, and lanolin, plus medication creates Command-O. Command-O combats the toughest cleaning task including grease, ink, tar, paint, dirt and stains.



- Conditioning agents protect hands and prevent drying, chapping and cracking
- Perfect for those whose hands are exposed to harsh, dirty working conditions
- No petroleum-based solvents

PART NO.	DESCRIPTION
8.704-635.0	Command-O Hand Cleaner with Pumice, 1 gal

## SCALEMASTER



- 12X
- 2 Lbs.

PART NO.	DESCRIPTION
8.759-762.0	

## HOSE REELS - LEGACY STACKABLE

Hose reels built specifically for contractors who require flexibility on a job site. Stackable reels are supported on both sides of the central hub to accommodate more aggressive applications, such as trailer-mounted.



200' Mild Steel Stackable Hose Reel Options

100' Mild Steel Stackable Hose Reel



Reel Cart System



Hose Reel Riser

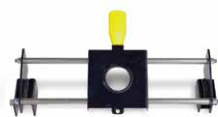

Hose Guide

- Integrated frame adds protection and stacking ability
- Stack up to 3 high
- Heavy-duty powder-coated steel or stainless steel
- Reel and swivel rated up to 6000 PSI and 350°F
- Modular design is able to configure for various needs
- Reversible hand-crank and swivel

PART NO.	DESCRIPTION
9.801-767.0	Stackable Hose Reel, Mild Steel, 100'
9.801-768.0	Stackable Hose Reel, Mild Steel, 200'
9.801-770.0	Stackable Hose Reel, Stainless-steel, 200'
OPTIONS	
8.923-415.0	Hose Guide, 100' Reel
8.923-427.0	Hose Guide, 200' Reel
8.923-416.0	Hose Reel Riser
8.923-918.0	Reel Cart System

NOTE: Hose not included

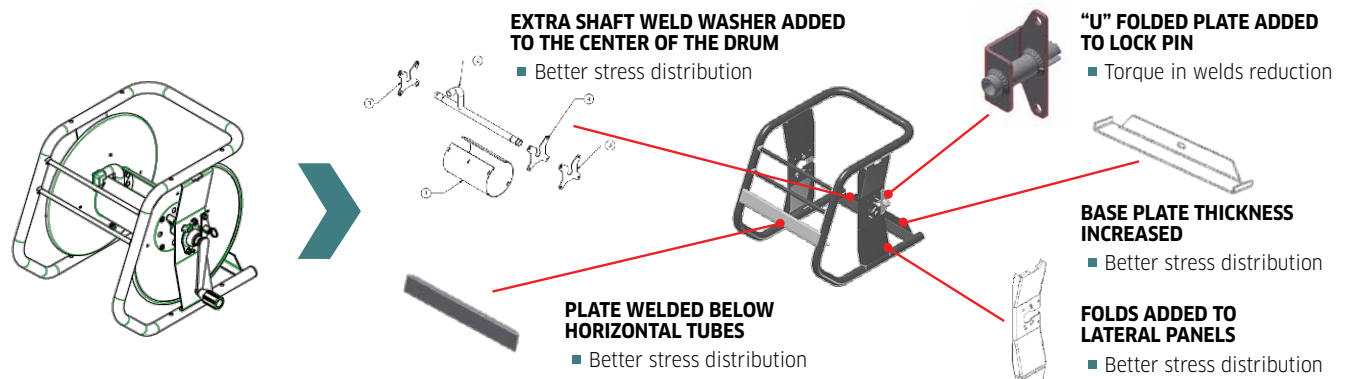

**HOSE REELS - LEGACY PIVOT & FIXED BASE**



Legacy hose reels were designed for ease of use and durability in commercial pressure washer applications. Offering 100' and 200' reels in both a fixed base and 360 degree rotating base. The oversized reel holds the advertised length plus leaves additional space reducing the difficulty of reeling hose. The unique extended swivel improves the hose connection and reduces hose wear and stress.



- PSI: 5000
- Temperature: 325°F
- 100' - 200' Fixed Base
- 100' - 200', 360° Rotating Base
- High-Pressure, Double-Seal Swivels
- Reels equipped for 3/8" hose. Easily convertible to 1/2" hose with the change to a 1/2" swivel
- 2-Year Warranty

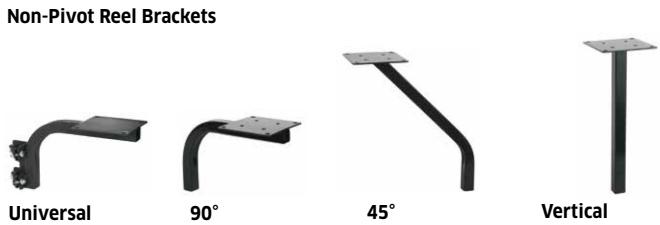

PART NO.	DESCRIPTION
8.750-485.0	Pivot Reel, 100' x 3/8"
8.750-482.0	Pivot Reel, 200' x 3/8"
8.750-476.0	Fixed Based, 100' x 3/8"
8.750-479.0	Fixed Based, 200' x 3/8"
8.920-142.0	Hose Reel, Trailer Mount, 100'
8.920-143.0	Hose Reel, Trailer Mount, 200'
8.919-430.0	Universal Mount
8.919-794.0	Skid Mount
8.919-437.0	Wall Mount
8.919-434.0	Base Mount
8.919-072.0	Bracket, Universal
8.919-445.0	Bracket, 90°
8.919-441.0	Bracket, 45°
8.919-448.0	Bracket, Vertical
9.121-043.0	Handle, Replacement

NOTE: Hose not included

**HOSE REELS - LEGACY SWIVELS**



- PSI: 5000
- Innovative Design
- Stainless-Steel Rotor
- Unique Dual Seal for Extra Long Life
- 2-Year Warranty
- O-Rings; BUNA-N



- PSI: 5000
- Limits Bend and Hose Stress
- Stainless-Steel Rotor
- Unique Dual Seal for Extra Long Life
- 2-Year Warranty
- O-Rings; BUNA-N

PART NO.	INLET X OUTLET
<b>SWIVEL</b>	
9.118-021.0	1/2" M x 3/8" F
8.776-003.0	3/8" F x 1/2" F
9.118-023.0	3/8" M x 3/8" F
9.118-024.0	3/8" F x 3/8" F
9.118-025.0	1/2" M x 1/2" F
9.118-026.0	1/2" F x 1/2" F
9.118-027.0	3/8" M x 1/2" F
9.118-028.0	1/2" F x 3/8" F
<b>UNIVERSAL REPAIR KIT</b>	
8.776-001.0	

PART NO.	INLET X OUTLET
<b>EXTENDED SWIVELS</b>	
9.118-020.0	1/2" M x 3/8" F
9.118-029.0	1/2" F x 3/8" F
9.118-030.0	3/8" M x 3/8" F
9.118-031.0	3/8" F x 3/8" F
9.118-034.0	1/2" F x 1/2" F
9.118-035.0	1/2" M x 1/2" F
9.118-032.0	3/8" F x 1/2" F
9.118-033.0	3/8" M x 1/2" F
<b>UNIVERSAL REPAIR KIT</b>	
8.776-001.0	



## HOSE REELS - AP

AP hose reels have been designed to perfectly balance ruggedness and durability with affordability.



- Working PSI: 4000
- Rated Temperature: 225°F
- 3/8" or 1/2" Inlet / Outlet
- Flared Flanges for Maximum Capacity
- Solid Center Core for Maximum Strength
- Rolled, Beaded-Edge Flanges for Maximum Safety
- Easy Mounting Options for Maximum Versatility
- "Posi-Pin" Lock Prevents Unwanted Dereeling
- Heavy-Duty Powder-Coated Steel
- Easy Access External Swivel

PART NO.	HOSE DIAMETER	CAPACITY (FT)	CORE WIDTH	FLANGE WIDTH	FLANGE DIAMETER	OVERALL HEIGHT
8.711-192.0	3/8"	50	4.3	7.9	10.5	13"
9.804-067.0	3/8"	100	8.7	12.2	10.5	13"
8.711-199.0	3/8"	150	6.3	10.2	13.0	16.7"
8.711-201.0	1/2"	100	6.3	10.2	13.0	16.7"
8.712-460.0	Replacement Swivel for Part No. 8.711-192.0 and 9.804-067.0					
8.712-469.0	Replacement Swivel for Part No. 8.711-199.0					
8.754-280.0	Replacement Swivel for Part No. 8.711-201.0					
8.700-188.0	Replacement Handle					

### SWIVEL REPAIR KITS

8.900-855.0

Note: Hose is not included. See page 168 for connector hose.



- Working PSI: 4000
- Rated Temperature: 225°F
- Super-Reinforced Core - Won't Collapse!
- Adjustable Brake for Controlled Reel Tension
- Convenient External Swivel
- Manual Rewind Handle Included
- Solid Core Bolts on to Flanges for Extra Strength
- Snap-Lock to Prevent Accidental Dereeling
- Bearings Have Oil Cap for Easy Field Maintenance

PART NO.	HOSE DIAMETER	CAPACITY (FT)	REEL SIZE WIDTH	REEL SIZE DIAMETER
8.711-179.0	3/8"	90	6"	14"
8.711-180.0	3/8"	140	10"	14"
8.711-181.0	3/8"	200	14"	14"
8.711-186.0	1/2"	115	10"	14"
8.711-187.0	1/2"	150	14"	14"
8.711-182.0	3/8"	150	6"	18"
8.711-183.0	3/8"	300	10"	18"
8.711-184.0	3/8"	350	14"	18"
8.711-189.0	1/2"	200	10"	18"
8.711-190.0	1/2"	270	14"	18"
8.715-921.0	Replacement Brake for Part No. 8.711-182.0 and 8.711-183.0			

NOTE: Hose is not included. Interchangeable parts available. Call for pricing. See page 168 for connector hose.

PART NO.	HOSE DIAMETER	DESCRIPTION
8.700-287.0	3/8"	Swivel Repair Kit
8.700-285.0	1/2"	Swivel Repair Kit
8.900-855.0*		Swivel Repair Kit

\*For Round Swivels. Replacement Swivels, See page 174-175.

**HOSE REELS - COXREELS**

Coxreels offer high performance in a very compact and lightweight hand crank or spring-driven hose reel. Perfect for mobile application and permanent floor and wall mount.



**8.711-858.0**

- Rated Up to 4000 PSI
- Temperature: -20°F to 225°F
- Adjustable Drag Brake
- 90° Brass Swivel



**8.725-347.0**

- Spring Driven Hose Reel
- Lightweight, Compact Design
- Adjustable Drag Break
- Sturdy U-Shaped Frame
- PSI: Up To 4000
- Rolled edges and ribbed discs provide strength and safety
- Pro-Grade Heavy-Duty Steel
- 2-Year Mfg Limited Warranty



**9.802-265.0**



**8.723-649.0**  
(Hose and Ball Stop Not Included)

PART NO.	DESCRIPTION	PSI
8.711-858.0	200' x 1/2" (300' x 3/8" with Adapter)	3000
8.725-347.0	100' x 3/8" - Fixed base hose reel	4000
8.711-860.0	100' x 3/8" - Challenger - Hand Crank Reel	4000
9.802-265.0	150' x 3/8" - Challenger - Hand Crank Reel	4000
8.723-649.0	50' x 3/8" - HPL Series - Spring Driven Reel	4000
8.723-718.0	100' x 3/8" - HPL Series - Spring Driven Reel	3000
8.711-591.0	Handle Replacement	
8.711-588.0	Locking Pin Assembly	
8.705-132.0	1/2" to 3/8" Adapter for 8.711-858.0	
8.750-020.0	Ball Stop for 8.723-649.0	
8.711-585.0	Replacement Swivel, 3/8"	
8.711-584.0	Replacement Swivel, 1/2"	
8.711-587.0	Swivel Repair Kit, 3/8"	
8.711-590.0	Swivel Repair Kit, 1/2"	





## HOSE REELS - GENERAL PUMP A-FRAME HOSE REELS

- Working PSI: 5000
- Rated Temperature: 250°F
- 1/2" NPT-F Inlet / Outlet
- Heavy Duty Powder Coated Steel
- Jumper/Pigtail Hose Not Included
- Stainless Steel Swivel Included



9.112-948.0



9.112-952.0  
(reel not included)



9.112-955.0  
(reel not included)



9.112-951.0  
(reels not included)

PART NO.	DESCRIPTION	PSI
9.112-948.0	DHRA50150, 150' x 3/8" Charcoal Gray Steel <b>A-frame Hose Reel</b> with Stainless-steel Swivel	5000
9.112-949.0	DHRA50300, 300' x 3/8" Charcoal Gray Steel <b>A-frame Hose Reel</b> with Stainless-steel Swivel	5000
9.112-950.0	DHRA50450, 450' x 3/8" Charcoal Gray Steel <b>A-frame Hose Reel</b> with Stainless-steel Swivel	5000
ACCESSORIES		
9.112-951.0	Hose Reel Stacking Kit, DHRA50150 A-frame c/w 150'/300' Cross Bracket	
9.112-952.0	Hose Guide Kit, DHRA50150 A-frame Hose Reel (reel not included)	
9.112-953.0	Hose Guide Kit, DHRA50300 A-frame Hose Reel (reel not included)	
9.112-954.0	Hose Guide Kit, DHRA50450 A-frame Hose Reel (reel not included)	
9.112-955.0	Hose Reel Cart, A-frame (150', 300', 450') Complete with DP80052 10" Solid PU Wheels (cart only)	
9.114-894.0	Kit Motor, Drive, Rings DHRA Rewind	
9.114-895.0	Ball Valve Nickel Plate 1/2" FXF 5000 PSI	

## NEW OFFERING HOSE REELS - GENERAL PUMP SWIVELS



9.112-946.0

PART NO.	DESCRIPTION	PSI	DESCRIPTION	MATERIAL
9.112-944.0	Swivel (D30001/02 / DHRWM50200)	4000	3/8"	Brass
9.112-945.0	Swivel, Hex Outlet with Arm (DHR50100, DHR50150, 2100357)	5000	3/8" NPT-F	Brass
9.112-946.0	Swivel, A-frame Hose Reels 440A, Bearing with Zerk Fitting, Electro-polished Surface, Viton Seals	5000	1/2" NPT	Stainless-steel
9.112-947.0	Swivel, A-frame Hose Reels 440A, Bearing with Zerk Fitting, Electro-polished Surface, Viton Seals	5000	3/8" NPT-F	Stainless-steel
9.114-676.0	Repair Kit for DHRA Hose Reel Swivel			

### LEGACY "BEST" SPRAY GUN

Ergonomically designed to be the most comfortable gun on the market.



- PSI: 5000
- GPM: 12
- Temperature: 300°F
- 3/8" FPT Inlet x 1/4" FPT Outlet
- Weight: 21 oz.

PART NO.	DESCRIPTION
8.751-213.0	"Best" Spray Gun
8.701-673.0	Unitized Valve Kit

### LEGACY "INDUSTRIAL" SPRAY GUN

Featuring a comfortable grip to reduce user fatigue.



- PSI: 5000
- GPM: 10.4
- Temperature: 300°F
- 3/8" FPT Inlet x 1/4" FPT Outlet
- Weight: 19.84 oz.

PART NO.	DESCRIPTION
8.751-214.0	"Industrial" Spray Gun
8.751-119.0	Valve Kit

### MV925 TRIGGER GUN

Economical easy pull trigger gun.



- PSI: 4500
- GPM: 8
- Temperature: 320°F
- 3/8" FPT Inlet x 1/4" FPT Outlet
- Weight: 16.08 oz.

PART NO.	DESCRIPTION
8.754-907.0	MV925

### M407 TRIGGER GUN



- PSI: 4000
- GPM: 7
- Temperature: 250°F
- 3/8" FPT Inlet x 1/4" FPT Outlet
- Weight: 13.4 oz.

PART NO.	DESCRIPTION
8.750-247.0	M407 Trigger Gun
8.750-456.0	M407 Gun Repair Kit

### ECONOMY TRIGGER GUN



- PSI: 5000
- GPM: 12
- Temperature: 300°F
- 3/8" Female Inlet x 1/4" Outlet
- Weight: 23 oz.
- Private Label this Gun  
*Ask your sales rep*

PART NO.	DESCRIPTION
9.113-082.0	A+ Trigger Gun
9.113-100.0	Unitized Valve Kit

### GIANT TRIGGER GUNS

The original "heavy-weight".



21290C

- PSI: 5000
- GPM: 10
- Temperature: 300°F
- 3/8" FPT Inlet x 1/4" FPT Outlet
- Weight: 29.28 oz.

PART NO.	DESCRIPTION
8.710-394.0	21290C - Brass Outlet
8.710-392.0	21250B - Stainless-Steel Outlet
8.722-172.0	Repair Kit for Giant 212990C and 21250B

### CERAMIC UNITIZED BALL VALVE



- Ceramic Ball
- Highly Resistant Against Nearly All Soaps and Acids
- Fits in ST-2300, 2305, 2605, 2700 Spray Guns as a Repair Kit

PART NO.	DESCRIPTION
8.749-907.0	Ceramic Unitized Ball Valve

### ST-2720 SUTTNER TRIGGER GUN



Designed for operators and applications with longer periods of cleaning time. Featuring the Relax-Action™ German engineered technology reduces trigger pulling force by 40% and holding force up to 90% compared to usual competitors spray gun.



- PSI: 1800
- GPM: 21.0
- Temperature: 300°F
- 3/8" Female NPT Inlet x 1/4" Female NPT Outlet
- Weight: 20 oz.

PART NO.	DESCRIPTION
8.723-667.0	ST-2720 Gun

**ST-2305 SUTTNER TRIGGER GUN** 

Easy pull trigger.



- PSI: 5000
- GPM: 12
- Temperature: 300°F
- 3/8" FPT Inlet x 1/4" FPT Outlet
- Weight: 16.22 oz.

PART NO.	DESCRIPTION
8.758-457.0	ST-2305 Spray Gun, Safety Orange

**ST-810 SUTTNER TRIGGER GUN** 

Excellent for truck and fleet washing applications.



- PSI: 2000
- GPM: 8
- Temperature: 320°F
- 3/8" FPT Inlet x 1/4" FPT Outlet
- Weight: 19.5 oz.

PART NO.	DESCRIPTION
8.710-372.0	ST-810 Gun

**ST-2605 SUTTNER TRIGGER GUN** 

Relax action design.



- PSI: 5000
- GPM: 12
- Temperature: 300°F
- 3/8" FPT Inlet x 1/4" FPT Outlet
- Weight: 21 oz.

PART NO.	DESCRIPTION
8.710-376.0	ST-2605
8.701-673.0	Unitized Valve

**ST-2305 SUTTNER TRIGGER GUN** 

Extreme durability with easy pull trigger and ceramic ball in valve for higher chemical resistance.



- PSI: 5000
- GPM: 12
- Temperature: 300°F
- 3/8" FPT Inlet x 1/4" FPT Outlet
- Weight: 21 oz.

PART NO.	DESCRIPTION
8.710-386.0	ST-2305
8.701-673.0	Unitized Valve
8.701-674.0	Unitized Weep Valve

**ST-2000 SUTTNER TRIGGER GUN** 

15° offset angle thru gun for easier overhead use. The handle style for "Big Hands".



- PSI: 5000
- GPM: 10.4
- Temperature: 300°F
- 3/8" FPT Inlet x 1/4" FPT Outlet
- Weight: 26 oz.

PART NO.	DESCRIPTION
8.710-388.0	ST-2000
8.751-119.0	Unitized Valve - 5000 PSI
8.701-665.0	Unitized Weep Valve

**ST-1500 SUTTNER TRIGGER GUN** 

The perennial favorite for general pressure washer applications.



- PSI: 5000
- GPM: 10.4
- Temperature: 300°F
- 3/8" FPT Inlet x 1/4" FPT Outlet
- Weight: 20.5 oz.

PART NO.	DESCRIPTION
8.710-384.0	ST-1500
8.710-385.0	ST-1500 with Weep
8.751-119.0	Unitized Valve - 5000 PSI
8.701-665.0	Unitized Weep Valve

**ST-2700 SUTTNER TRIGGER GUN** 

Relax action design, stainless-steel gun.



- PSI: 5000
- GPM: 12
- Temperature: 300°F
- 3/8" FPT Inlet x 1/4" FPT Outlet
- Weight: 21 oz.

PART NO.	DESCRIPTION
8.710-389.0	ST-2700
8.701-658.0	Unitized Valve

**ST-2315 SUTTNER TRIGGER GUN** 

Extreme durability with easy pull trigger.



- PSI: 5000
- GPM: 12
- Temperature: 300°F
- 3/8" FPT Inlet x 1/4" FPT Outlet
- Weight: 20.8 oz.

PART NO.	DESCRIPTION
9.106-073.0	ST-2315, Ceramic Ball Valve for Chemical and Acid Resistance

### PA TRIGGER GUN

Great for truck and fleet wash.



- PSI: 3200
- GPM: 8
- Temperature: 320°F
- 3/8" FPT Inlet x 1/4" FPT Outlet
- Weight: 10 oz.

PART NO.	DESCRIPTION
8.710-440.0	RL20
8.704-180.0	Repair Kit

Compact feel for smaller hands.



- PSI: 5000
- GPM: 10.5
- Temperature: 320°F
- 3/8" FPT Inlet x 1/4" FPT Outlet
- Weight: 26 oz.

PART NO.	DESCRIPTION
8.710-377.0	RL30-YG5000
8.704-616.0	Repair Kit



- PSI: 5000
- GPM: 10.5
- Temperature: 320°F
- 3/8" FPT Inlet x 1/4" FPT Outlet
- Weight: 27.5 oz.

PART NO.	DESCRIPTION
8.710-378.0	Vega 5000
8.704-232.0	Valve Kit Vega
8.704-615.0	Repair Kit

Easy pull and easy to hold with matching blue lance.



- PSI: 5650
- GPM: 8
- Temperature: 320°F
- 3/8" FPT Inlet x 1/4" FPT Outlet
- Weight: 23.3 oz.
- Blue Vent Grip, Stainless-steel Lance has 1/4" BSP Threads

RL-56 Gun



40" Stainless-Steel Blue Grip Lance

PART NO.	DESCRIPTION
9.802-227.0	RL-56 Blue Gun and Wand (nozzle protector not included)
8.710-446.0	RL-56 Blue Gun
8.710-645.0	40" Stainless-Steel Lance, blue vent grip (with nozzle protector)
8.704-610.0	Repair Kit, RL-55/RL-56

### PA LINEAR GUN

Ergonomic design minimizes fatigue for operator.



- PSI: 4500
- GPM: 10.5
- Temperature: 320°F
- 3/8" FPT Inlet x 1/4" FPT Outlet
- Weight: 19.2 oz.

PART NO.	DESCRIPTION
8.752-080.0	PA Linear Gun
9.801-398.0	PA Linear Gun Repair Kit

### SUTTNER TRIGGER GUN



15° offset angle thru gun for easier overhead use.



- PSI: 4000
- GPM: 12
- Temperature: 300°F
- 3/8" FPT Inlet x 1/4" FPT Outlet
- Weight: 23 oz.

PART NO.	DESCRIPTION
8.710-370.0	ST-601
8.751-119.0	Unitized Valve - 5000 PSI

### BIG GUN



- PSI: 3200
- GPM: 53
- Temperature: 210°F
- 3/4" FPT Inlet x 1/2" FPT Outlet
- Weight: 47.5 oz.

Model RL204



- PSI: 7250
- GPM: 21
- Temperature: 210°F
- 1/2" Stainless-Steel FPT Inlet / Outlet
- Weight: 60.3 oz.

Model RL84 "Big Black Gun"

PART NO.	DESCRIPTION
8.740-165.0	Model RL204
8.749-327.0	Repair Kit - Model RL204
8.704-136.0	Repair Kit - Model 100
8.704-612.0	Repair Kit - Model 160
8.710-445.0	Model RL84
8.750-459.0	Repair Kit - RL84

### ML320

Excellent light-duty gun.



- PSI: 2320
- GPM: 6.6
- Temperature: 212°F
- 1/4" M Inlet x 1/4" F Outlet
- Weight: 8.82 oz.

PART NO.	DESCRIPTION
8.757-839.0	ML320

### GP LOCKING TRIGGER GUN

Rear Entry Spray Gun, Locking Trigger.



- PSI: 5000
- GPM: 10.5
- Temperature: 320°F
- 3/8" NPT-F Inlet x 1/4" NPT-F Outlet
- Weight: 22.4 oz.

PART NO.	DESCRIPTION
9.113-653.0	DGE5010SL

## OPEN GUNS

Flow through design offers less downtime for repair

### AP1000 OPEN GUN

Durable glass reinforced handle. Tubular flow-thru intervals for high pressure and efficiency.



- PSI: 4000
- GPM 12
- Temperature: 300°F
- 3/8" FPT Inlet x 1/4" FPT Outlet
- Weight: 16.7 oz.

PART NO.	DESCRIPTION
8.710-396.0	AP1000 Open Gun
8.750-951.0	AP1000 Weep Gun with Blue, Lock

### MV 925 OPEN GUN

Just plain comfortable!



- PSI: 4060
- GPM 8
- Temperature: 300°F
- 3/8" FPT Inlet x 1/4" FPT Outlet
- Weight: 12.3 oz.

PART NO.	DESCRIPTION
8.754-988.0	MV925 without trigger

### ST-1500H OPEN GUN



- PSI: 5000
- GPM 10.4
- Temperature: 300°F
- 3/8" FPT Inlet x 1/4" FPT Outlet
- Weight: 20.5 oz.

PART NO.	DESCRIPTION
8.710-383.0	ST-1500 Open Gun

### FLOW-THRU GUN

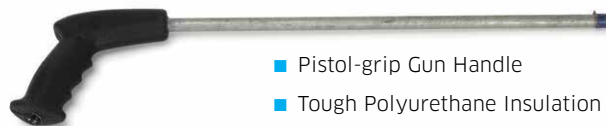

"Full" Grip

- Pistol-grip Gun Handle
- Tough Polyurethane Insulation
- Cushion Grip
- Full Grip or Slim Line Handle

PART NO.	DESCRIPTION
8.710-400.0	Full Black Grip 3/8" FPT x 1/4" FPT
GUN HANDLE WITH 18" LANCE	
8.710-403.0	Slim Red Grip 1/4" M x 1/4" F
8.710-404.0	Full Red Grip 3/8" F x 1/4" M

### AP DUMP GUN

Water continues to run through the tube even when trigger gun is closed.



- PSI: 3000
- GPM: 10.5
- Temperature: 140°F
- 3/8" FPT Inlet x 1/8" FPT Outlet

PART NO.	DESCRIPTION	WEIGHT
8.710-405.0	Dump Gun 16" Lance	45.15 oz.
8.710-406.0	Dump Gun 40" Lance	59.61 oz.
8.704-169.0	Repair Kit	

### DUMP GUN- SJ3000

Industrial duty dual-barrel.



- PSI: 3000
- GPM: 10
- Temperature: 300°F
- 3/8" FPT Inlet x 1/4" FPT Outlet
- Includes: QC Socket at Inlet and QC Plug at Outlet

PART NO.	DESCRIPTION
8.710-408.0	Dump Gun with 36" Barrel
8.700-311.0	Repair Kit

### VP DUAL LANCE

Superlite stainless-steel with nozzle guard and 1/4" stainless-steel outlet tubing.



- PSI: 4000
- 1/4" stainless steel tubes
- Fully insulated
- Forged Brass Valve Body with stainless steel valve bushing

PART NO.	DESCRIPTION
8.711-308.0	41"

### DUAL LANCES

Interpump Dual Lance. Excellent for downstream injector and zinc-plated for chemical resistance.



**36" Standard Dual Lance**  
8.710-612.0



**36" Dual Vented Lance**  
9.114-032.0

- | Dual Lance                     | Deluxe Dual Lance                                    | Dual Vented Lance                                 |
|--------------------------------|--|---|
| ■ PSI:4050                     | ■ PSI:4050   | ■ PSI: 4050                                       |
| ■ GPM: 10.5                    | ■ GPM: 10.5  | ■ GPM: 10.5                                       |
| ■ Temperature: 284°F           | ■ Temperature: 284°F                                 | ■ Temp; 284°F                                     |
| ■ Side Handle Valve Adjustment | ■ Side Handle Valve Adjustment                       | ■ 1/4" QC Nozzle Holder                           |
| ■ 1/4" Male Inlet              | ■ 1/4" Male Inlet                                    | ■ 1/4" Soap Nozzle included                       |
| ■ 1/4" Dual Outlet             | ■ 1/4" Dual Outlet                                   | ■ 1/4" MPT inlet *(Does not include male inlet QC |
|                                | ■ Includes: 1/4" QC Brass Coupler, Brass Soap Nozzle |   |

PART NO.	DESCRIPTION
<b>DUAL LANCE</b>	
8.710-612.0	36" Standard
8.710-621.0	72" Extended
<b>DELUXE DUAL LANCE</b>	
8.904-281.0	72" Deluxe Extended
<b>DUAL VENTED LANCE</b>	
9.114-032.0	36" Dual Vented
<b>REPAIR KIT</b>	
8.900-135.0	Valve Repair Kit

### DUAL LANCES

Premium dual lance with stainless-steel inset.



**AL344LS-VP Lance**  
8.710-722.0



**AL 333 Basic Lance**  
8.710-724.0

- | AL 333 Basic Lance        | AL344LS VP Lance  |
|---------------------------|---|
| ■ 3650 PSI                | ■ 4000 PSI  |
| ■ GPM: 10.5               | ■ GPM: 10.5   |
| ■ Temperature: 300°F      | ■ Temperature: 302°F  |
| ■ 1/4" Male Inlet         | ■ 1/4" Male Inlet   |
| ■ 1/4" F NPT Dual Outlets | ■ Stainless Steel Seat & 40" Vented Grip                            |
| ■ 40" Molded Grip         | ■ 1/4" Stainless-steel Tubes  |
| ■ 1/8" Zinc-plated Tubes  | ■ 1/4" & 1/8" F NPT Dual Outlets                                    |
|                           | ■ (QC nozzles not included)   |
|                           | <b>AL344LS VPKIT - Premium</b>                                      |
|                           | ■ Includes: 1/4" QC & Soap Nozzle, Nozzle Protector and Valve Cover |
|                           | <b>AL344LS VPKIT - Standard</b>                                     |
|                           | ■ Nozzle Protector and Valve Cover only                             |

PART NO.	DESCRIPTION
<b>DUAL LANCE</b>	
8.710-724.0	40 " AL333 Basic Dual Lance
8.710-722.0	40" AL344LS-VPKIT Standard Dual Lance
8.904-360.0*	40" AL344LS-VPKIT Premium Dual Lance with 1/4" QC Brass Inlet Plug

REPAIR KIT	
8.720-548.0	AL333 Repair Kit
9.803-267.0	AL344 Repair Kit

\*Model includes a hardened-steel QC inlet plug.



## DUAL LANCES

Dual lances allow for easy switching between high pressure cleaning and low pressure chemical application (chemical injector required). Stainless steel pipes give increased life when applying variable Ph products.

### SUTTNER DUAL LANCES

High-pressure, thin-wall tubing and zinc / chromate finish.



#### ST-54 with Side Handle

- PSI: 4000 or 4500
- GPM: 10
- Temperature: 300°F

#### ST-53 with Knob

- 38" Total Length, Molded Grip
- Weight: 42 oz.

PART NO.	DESCRIPTION
8.710-613.0	ST-53 with Knob (4000 PSI)
8.710-614.0	ST-54 with Side Handle (4500 PSI)
8.701-594.0	Repair Kit (ST-53)
8.900-153.0	Clamp Kit (ST-53/54)
8.701-602.0	Repair Kit (ST-54)

### LEGACY SQUARE MOLDED GRIP LANCES

High-quality chrome-plate finish. Solid molded polymer construction and handle with hollow-rib for increased heat dissipation.



- PSI: 5250
- GPM: 12
- Temperature: 300°F
- 1/4" Male Inlet and Outlet

PART NO.	DESCRIPTION
8.752-898.0	Lance, Molded, 12"
8.752-899.0*	Lance, Molded, 20"
8.752-900.0	Lance, Molded, 24"
8.752-901.0	Lance, Molded, 28"
8.752-902.0*	Lance, Molded, 36"
8.752-903.0	Lance, Molded, 48"
8.752-904.0	Lance, Molded, 60"
8.752-905.0*	Lance, Molded, 79"

\*BENT VERSION AVAILABLE Call representative for pricing and to order.

### LEGACY OVAL MOLDED GRIP LANCES



A comfortable grip reducing fatigue and a stainless-steel or high-quality chrome-plated finish. Solid molded polymer construction and handle with hollow-rib for increased heat dissipation.



- PSI: 5250
- Temperature: 300°F
- 1/4" Male Inlet and Outlet
- Bent or Straight lance options

PART NO.	DESCRIPTION
<b>STAINLESS-STEEL</b>	
8.752-882.0	Lance, Molded, 12"
8.752-883.0*	Lance, Molded, 20"
8.752-884.0* S	Lance, Molded, 24"
8.904-301.0	Lance, Molded, 24", Bent 15°
8.752-885.0	Lance, Molded, 28"
8.904-302.0	Lance, Molded, 28", Bent 15°
8.752-886.0*	Lance, Molded, 36"
8.752-887.0	Lance, Molded, 48"
8.904-304.0	Lance, Molded, 48", Bent 15°
8.904-303.0	Lance, Molded, 36", Bent 15°
8.752-888.0*	Lance, Molded, 60"
8.752-889.0* S	Lance, Molded, 79"
8.904-306.0	Lance, Molded, 79", Bent 15°
<b>CHROME-PLATED</b>	
8.752-890.0	Lance, Molded, 12"
8.752-891.0	Lance, Molded, 20"
8.752-892.0* S	Lance, Molded, 24"
8.752-893.0	Lance, Molded, 28"
8.752-894.0	Lance, Molded, 36"
8.752-906.0	Lance, Molded, 36", with handle
8.904-324.0	Lance, Molded, 36", with handle, Bent 15°
8.752-895.0	Lance, Molded, 48"
8.752-907.0	Lance, Molded, 48", with handle
8.752-896.0 S	Lance, Molded, 60"
8.752-897.0	Lance, Molded, 79"

\*BENT VERSION AVAILABLE Call representative for pricing and to order.

### SUTTNER LANCES

High-pressure, thin-wall tubing and stainless steel finish..



PART NO.	DESCRIPTION
<b>15 DEG BENT</b>	
9.113-700.0	Molded 36" SS 6000 PSI
9.113-701.0	Molded 48" SS 6000 PSI
<b>STRAIGHT</b>	
9.113-704.0	Molded Grip 48" SS Lance 6000 PSI
9.113-705.0	Molded Grip 36" SS Lance, 6000 PSI

### AP UNINSULATED LANCES

Stainless-steel or corrosion-resistant, bright zinc-plated lances made with 1/4" high-pressure, lightweight, thin-wall tubing and superior strength rolled threads.



- PSI: 4100
- Temperature: 300°F

PART NO.	DESCRIPTION
<b>STAINLESS-STEEL</b>	
8.710-623.0	Length, 12"
8.710-624.0*	Length, 20"
8.904-285.0	Length 20", Bent 15°
8.710-625.0*	Length, 24"
8.904-286.0	Length 24", Bent 15°
8.710-626.0	Length, 28"
8.710-627.0	Length, 36"
8.710-628.0 <b>S</b>	Length, 48"
8.710-629.0	Length, 60"
8.710-630.0	Length, 78"
8.904-291.0	Length 78", Bent 15°
<b>ZINC-PLATED</b>	
8.710-631.0	Length, 12"
8.710-632.0	Length, 20"
8.710-633.0	Length, 24"
8.710-634.0*	Length, 36"
8.710-635.0* <b>S</b>	Length, 48"
8.710-636.0	Length, 60"
8.904-297.0	Length 60", Bent 15°
8.710-637.0	Length, 78"
8.904-298.0	Length 78", Bent 15°

\*BENT VERSION AVAILABLE Call representative for pricing and to order.

### LEGACY VENTED LANCES

Stainless-steel or high-quality chrome-plate finish with molded glass-filled polyamide handle for heat dissipation with hollow insulators for increased heat venting.



- PSI: 5250
- Temperature: 300°F
- 1/4" Male Inlet, 1/4" Female Outlet

PART NO.	DESCRIPTION
<b>STAINLESS-STEEL</b>	
8.752-868.0	Lance, Vented, 20"
8.752-869.0	Lance, Vented, 24"
8.752-871.0 <b>S</b>	Lance, Vented, 36"
8.752-872.0	Lance, Vented, 48"
8.752-873.0	Lance, Vented, 60"
8.752-874.0	Lance, Vented, 79"
<b>CHROME-PLATED</b>	
8.752-875.0	Lance, Vented, 20"
8.752-876.0	Lance, Vented, 24"
8.752-878.0	Lance, Vented, 36"
8.752-879.0	Lance, Vented, 48"
8.752-880.0	Lance, Vented, 60"
8.752-881.0	Lance, Vented, 79"

### SUTTNER PUSH AND PULL LANCE

Vented grip can be pushed and pulled up to 90°. For hard to reach applications, such as gutters, fenders, trucks and heavy equipment.



- PSI: 3050
- Temperature: 300°F
- 34" Stainless-Steel Lance

PART NO.	DESCRIPTION
8.710-711.0	ST-85 Push and Pull Lance
8.710-720.0	Handle, Side

### BIG STAINLESS-STEEL LANCES & SIDE HANDLES

For big guns! Complete with an adjustable handle and coupler for 1/4" MPT nozzle and high-pressure stainless-steel pipe.



- Temperature: 300°F
- Schedule 40 Pipe
- 1/2" MPT Gun Connection

PART NO.	DESCRIPTION	PSI
8.904-081.0	20" Wand with Handle	4050
8.904-083.0	40" Wand with Handle	4050
8.904-086.0	Side Handle Only	-
8.710-411.0	39", Stainless-steel, 300°F, Inlet 1/2" MNPT, Outlet 1/4" FMPT ST-3600	8700



### LANCE HANDLES / ACCESSORIES

Vented grip, side handle with nut, and vented grip with side handle, can be user-attached to uninsulated lances or 1/4" steel pipe. Detachable and reusable!



PART NO.	DESCRIPTION
8.710-717.0	Vent Grip Only (14" long)
8.904-357.0	Grip with Side Handle



PART NO.	DESCRIPTION
8.710-716.0	Vent Grip Only (14" Long) ST-9
8.710-719.0	Grip with Side Handle
8.710-720.0	Side Handle with Nut

### MV LANCE HANDLE



- Use On All 1/4" Lances
- Easily Positioned without Removal of Nozzle

PART NO.	DESCRIPTION
8.704-162.0	1/4" Lance Handle

### GUTTER CLEANER ATTACHMENT

Easily quick connect to any lance or extension wand to clean gutters or hard to reach areas. The angle improves reach and expands cleaning capabilities. For use with 5.0 or larger nozzle.



- PSI: 3500
- Temperature: 200°F
- Zinc-Plated
- Inlet 1/4" F Socket
- Outlet 1/4" M Plug

PART NO.	DESCRIPTION
8.711-324.0	1/4" Nipple x 1/4" QC

### FIBERGLASS TELESCOPING WANDS

High-quality telescoping wand can reach up to 24' with three sizes to choose from. A lightweight wand that is balanced under pressure.



- PSI: 4000
- GPM: 10.5
- Temperature: 195°F
- 6' - 12' Wand Shown

Belt and Pole Clamp



Telescoping Wand

PART NO.	DESCRIPTION
8.710-589.0	6'-12'
8.710-590.0	6'-18'
8.710-591.0	8'-24'
8.700-059.0	Strap and Belt Shoulder Harness
8.711-324.0	Gutter Cleaning Attachment
8.723-896.0	TS12 Replacement Gun
8.710-595.0	TS18 Replacement Gun
8.739-434.0	TS24 Replacement Gun

### SPRAY-FLEX™ FLEX WAND

Access difficult spots easily. Great for cleaning engines, roofs, eaves, or underneath almost anything! Holds its shape under pressure.



- PSI: 3000 or 5000
- Temperature: 190°F
- 90° Flexibility
- 12" 1/4" NPT x 1/4" NPT

PART NO.	DESCRIPTION
8.710-597.0	3000 PSI
8.710-596.0	5000 PSI

### FLEX LANCES

Save on broken wand repairs! Flexes a full 180° and returns, preventing bent lances and broken hose. Ideal for self-serve car wash bays.



- PSI: 2500
- Temperature: 200°F
- Industrial-Grade Polyurethane Flex Section
- Galvanized Pipe Ends

PART NO.	DESCRIPTION
8.710-598.0	18", 1/4" MPT x 1/4" MPT
8.710-603.0	21", 1/4" MPT x 1/8" FPT
8.710-604.0	24", 1/4" MPT x 1/8" FPT

### HOBBY GUN, LANCE AND HOSE

Don't turn away hobby-unit owners. Complete replacement hose, gun and lance.



#### Insulated Lance with Gun

- PSI: 4500
- GPM: 8
- Temperature: 320 F
- 3/8" NPT Inlet

#### Lance with Coupler

- PSI: 3000
- Temperature: 140 F

#### Lance with 3 Hi/Low Varifan Nozzle

- PSI: 2000
- GPM: 5.5

#### 1/4" x 25" Thermoplastic

- PSI: 3600
- Temperature: 140 F

PART NO.	DESCRIPTION
8.754-769.0	Insulated Lance with Gun
8.753-272.0	18" Lance with #3 Hi / Low Varifan Nozzle
8.753-423.0	1/4"x25" Thermoplastic, 22mm both ends

NOTE: See page 166 for more Hobby Hose



### GUN, DUAL LANCE COMBO

- PSI: 5000
- GPM: 12
- Temperature: 300°F
- Stainless Steel Seat
- 1/4" Stainless Steel Tubes
- 1/4" QC Brass Socket
- 1/8" 40x65 brass soap nozzle
- Weight: 39 oz.

PART NO.	DESCRIPTION
8.930-771.0	40" with 5000 psi 12 GPM gun

### LEGACY INDUSTRIAL GUN AND LANCE COMBO



Gun and lance combo with 36" square-molded grip lance and 1/4" quick coupled socket. Includes nozzle protector.



- PSI: 5000
- GPM: 10.4
- Temperature: 300°F
- Zinc-Plated Steel Tubes
- Stainless-Steel Seat
- Weight: 39 oz.

PART NO.	DESCRIPTION
8.904-095.0	Legacy Gun and Lance with 3/8" MPT QC Inlet

### MV925 GUN AND LANCE COMBO

Gun and lance combo with pre-assembled 36" square grip lance.



- PSI: 4500
- 1/4" FPT QC Socket Installed on Outlet of Lance
- GPM: 8.0
- 3/8" MPT QC Nipple Installed on Inlet of Gun

PART NO.	DESCRIPTION
8.928-442.0	MV925 Gun

### MV925 GUN, LANCE AND HOSE COMBO

Gun, lance and hose combo with 36" square grip lance and 50' hose.



- PSI: 4000
- 3/8" MPT QC Nipple Installed on Inlet of Gun
- 1/4" FPT QC Socket Installed on Outlet of Lance
- GPM: 8
- R1 4000 PSI 3/8" x 50' Black Hose
- 3/8" FPT QC Sockets Installed on Hose

PART NO.	DESCRIPTION
8.928-443.0	MV925 Gun

## HOSE - LEGACY HIGH-PRESSURE

For use with hot or cold-water pressure washers. The Legacy hose is built to exceed the EN1829-2 Standard and will provide superior abrasion resistance that will increase the life of the hose.



Both single-and double-wire braid hoses come with durable 8" bend restrictors on both ends. The Legacy hose has a "bite-the -wire" coupling that grips the hose better than any other design and is far superior to the "compression fittings" used on conventional hoses.

- Easily Identified: Permanently embossed identification makes for easy tracing and owner protection.
- This heavy duty hose is reinforced with braided, high tensile steel wire and a very durable cover.

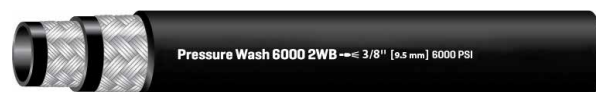

## HOSE - 1-WIRE



- Rated to 250°F
- Smooth impression, oil resistant tube and **Black Hose Guard** at both ends

PART NO.	SIZE	PSI
<b>3/8" MPT SWIVEL X 3/8" MPT SOLID, 3/8" ID</b>		
8.925-176.0	3/8" x 15'	4000
8.925-150.0	3/8" x 25'	4000
8.925-156.0	3/8" x 50'	4000
8.925-161.0	3/8" x 75'	4000
8.925-165.0	3/8" x 100'	4000
8.925-170.0	3/8" x 150'	4000
8.925-350.0	3/8" x 200'	4000
8.925-378.0	Case of 75 (8.925-156.0) 3/8" x 50' Hoses	
8.925-449.0	Case of 40 (8.925-165.0) 3/8" x 100' Hoses	
<b>3/8" MPT SWIVEL X 3/8" MPT SWIVEL, 3/8" ID</b>		
8.925-364.0	3/8" x 50'	4000
8.925-365.0	3/8" x 75'	4000
8.925-167.0	3/8" x 100'	4000
8.925-367.0	3/8" x 150'	4000
8.925-368.0	3/8" x 200'	4000
<b>1/4" MPT SWIVEL X 1/4" MPT, SOLID, 1/4" ID</b>		
8.925-143.0	1/4" x 25'	4000
8.925-144.0	1/4" x 30'	4000
8.925-145.0	1/4" x 50'	4000
8.925-146.0	1/4" x 75'	4000
8.925-147.0	1/4" x 100'	4000
<b>1/2" MPT SWIVEL X 1/2" MPT SOLID</b>		
8.925-236.0	50'	3000
8.925-237.0	75'	3000
8.925-238.0	100'	3000
<b>BLACK WRAPPED HOSE SWXSO</b>		
9.113-845.0	3/8" x 50'	4000
9.113-846.0	3/8" x 100'	4000

## HOSE - 2-WIRE



- Rated to 250°F
- Smooth impression, oil resistant tube and **Red Hose Guard** at both ends

PART NO.	SIZE	PSI
<b>3/8" MPT SWIVEL X 3/8" MPT SOLID, 3/8" ID</b>		
8.928-542.0	3/8" x 15'	6000
8.925-180.0	3/8" x 25'	6000
8.925-184.0	3/8" x 50'	6000
8.925-225.0	3/8" x 75'	6000
8.925-229.0	3/8" x 100'	6000
8.925-232.0	3/8" x 150'	6000
8.925-369.0	3/8" x 200'	6000
8.925-382.0	Case of 75 (8.925-184.0) 3/8" x 50' Hoses	
8.925-450.0	Case of 40 (8.925-229.0) 3/8" x 100' Hoses	
<b>3/8" MPT SWIVEL X 3/8" MPT SWIVEL, 3/8" ID</b>		
8.925-311.0	3/8" x 25'	6000
8.925-313.0	3/8" x 50'	6000
8.925-314.0	3/8" x 75'	6000
8.925-316.0	3/8" x 100'	6000
8.925-325.0	3/8" x 200'	6000
<b>1/2" MPT SWIVEL X 1/2" MPT SOLID</b>		
8.925-247.0	1/2" x 50'	5000
8.925-249.0	1/2" x 75'	5000
8.925-253.0	1/2" x 100'	5000
<b>BLACK WRAPPED HOSE SWXSO</b>		
9.113-847.0	3/8" x 50'	6000
9.113-848.0	3/8" x 100'	6000

### 1,000 FOOT REELS

<b>9.113-139.0</b>	3/8" Hose R1	4000 PSI	Black
<b>9.113-140.0</b>	3/8" Hose R2	6000 PSI	Black
<b>9.113-141.0</b>	1/4" Hose R1	4000 PSI	Black

Note: Full Reel - 1000 ft per reel, hose only. Max of 3 incremental cuts per reel, industry standard. Call your sales representative for pricing.

**HOSE - LEGACY 1- & 2-WIRE WITH COUPLERS OR M22 ENDS**



- Temperature: 250°F
- Coupler and Plug Included
- 3/8" ID - Solid / Swivel & Swivel / Swivel options available



PART NO.	LENGTH	DESCRIPTION	WORKING PSI	APPROX WT (LBS.)
<b>3/8" BLACK HOSE, R1</b>				
8.928-928.0	50'	3/8" ID Solid X Swivel	4000	13.0
8.928-929.0	100'	3/8" ID Solid X Swivel	4000	24.0
8.930-772.0	50'	Swivel X Swivel	4000	13.0
8.930-773.0	100'	Swivel X Swivel	4000	24.0
8.931-290.0	50'	M22 Fittings	4000	
8.931-291.0	100'	M22 Fittings	4000	
8.931-292.0	30'	M22 Fittings	4000	
<b>3/8" BLACK HOSE, R2</b>				
8.928-930.0	50'	3/8" ID Solid X Swivel	6000	18.0
8.928-931.0	100'	3/8" ID Solid X Swivel	6000	33.0
8.930-774.0	50'	Swivel X Swivel	6000	18.0
8.930-775.0	100'	Swivel X Swivel	6000	33.0
8.931-293.0	50'	M22 Fittings	6000	
8.931-294.0	100'	M22 Fittings	6000	
8.931-295.0	30'	M22 Fittings	6000	

**HOSE - GRAY NON-MARKING 1 & 2-WIRE - WITH & WITHOUT COUPLERS**

- Tough, Abrasive Resistant Wrapped Cover
- Oil Resistant Non-Marking
- For use with Hot or Cold Water



PART NO.	LENGTH	DESCRIPTION	WORKING PSI	APPROX WT (LBS.)
<b>3/8" GRAY HOSE</b>				
9.114-440.0	50'	3/8" GRAY HOSE- SO x SW	R1 - 4200	12
9.114-441.0	100'	3/8" GRAY HOSE- SO x SW	R1 - 4200	24
9.116-070.0	200'	SO/SW	R1 - 4200	
9.114-442.0	50'	3/8" GRAY HOSE- SO x SW	R2 - 6000	19
9.114-443.0	100'	3/8" GRAY HOSE- SO x SW	R2 - 6000	36
9.116-071.0	200'	SO/SW	R2 - 6000	
<b>3/8" GRAY HOSE W/ COUPLERS &amp; PLUGS</b>				
9.115-117.0	50'	Brass QCs	R1 - 4200	13
9.115-118.0	100'	Brass QCs	R1 - 4200	25
9.116-085.0	200'	Brass QCs	R1 - 4200	
9.115-119.0	50'	SS QCs	R2 - 6000	20
9.115-120.0	100'	SS QCs	R2 - 6000	37
9.116-086.0	200'	SS QCs	R2 - 6000	

### HOSE - LEGACY 1-WIRE SMOOTH COVER, NON-MARKING



- Temperature: 250°F
- 1/4" & 3/8" Smooth Non-Marking
- 3/8" MPT Solid X 3/8" Swivel Ends



PART NO.	LENGTH	WORKING PSI	APPROX WT (LBS.)
<b>3/8" SMOOTH YELLOW HOSE</b>			
8.901-800.0	50' x 3/8" ID	3000	12.0
8.901-802.0	75' x 3/8" ID	3000	17.0
8.901-804.0	100' x 3/8" ID	3000	23.0
8.757-441.0	500' Reel	3000	115.0
<b>3/8" SMOOTH BLUE HOSE</b>			
8.739-148.0	50' x 3/8" ID	3000	12.0
8.739-149.0	75' x 3/8" ID	3000	17.0
8.739-150.0	100' x 3/8" ID	3000	23.0
8.739-369.0	150' x 3/8" ID	3000	34.0
8.925-296.0	200' x 3/8" ID	3000	45.0
8.757-442.0*	500' Reel	3000	115.0
<b>3/8" SMOOTH GRAY HOSE</b>			
8.749-935.0	50' x 3/8" ID	3000	13.0
8.749-936.0	100' x 3/8" ID	3000	25.0
8.757-443.0*	500' Reel	3000	125.0
<b>1/4" SMOOTH BLUE HOSE</b>			
8.901-796.0	50' x 1/4" ID	3000	8.0
8.901-798.0	100' x 1/4" ID	3000	16.0

\*Full Reel - 500 ft per reel, hose only. Max of 3 incremental cuts per reel, industry standard.

### HOSE - LEGACY 1- & 2-WIRE, NON-MARKING



- Temperature: 250°F
- Blue Smooth Non-Marking
- SO / SW Couplers Not Included



PART NO.	LENGTH	WORKING PSI	APPROX WT (LBS.)
<b>3/8" SMOOTH BLUE HOSE - R2</b>			
8.739-229.0	50' R2	4500	17.0
8.739-231.0	100' R2	4500	33.0
8.925-320.0	150' R2	4500	
8.757-438.0*	500' Reel	4500	165.0
<b>1/2" SMOOTH BLUE HOSE - R1</b>			
8.925-300.0	1/2" x 75'	3000	25.0
8.757-439.0*	500' Reel	3000	167.0

\*Full Reel - 500 ft per reel, hose only. Max of 3 incremental cuts per reel, industry standard.

### HOSE - A+ 1-WIRE GRAY SMOOTH COVER, NON-MARKING



- Temperature: 250°F
- 3/8" MPT Swivel x 3/8" MPT Solid



PART NO.	LENGTH	DESCRIPTION	PSI	APPROX WT (LBS.)
<b>3/8" SMOOTH COVER, GRAY HOSE</b>				
8.921-617.0	3/8" x 25'	4K Gray A+ SOXSW	4000	6.0
8.921-618.0	3/8" x 50'	4K Gray A+ SOXSW	4000	11.0
8.921-619.0	3/8" x 75'	4K Gray A+ SOXSW	4000	17.0
8.921-620.0	3/8" x 100'	4K Gray A+ SOXSW	4000	33.0
8.752-156.0*	600' Reel	4K Gray A+	4000	165.0

\*Full Reel - 600 ft per reel, hose only. Max of 3 incremental cuts per reel, industry standard.

**HOSE - A+ 1- & 2-WIRE WITH COUPLING AND PLUG, NON-MARKING**



- Temperature: 250°F
- Couplers and Plug Included
- 3/8" MPT Swivel x 3/8" MPT Solid

PART NO.	LENGTH	WORKING PSI	APPROX WT (LBS.)
<b>3/8" 1-WIRE BLUE HOSE</b>			
8.928-971.0	50' x 3/8" ID	4000	13.0
8.928-972.0	100' x 3/8" ID	4000	23.0
<b>3/8" 2-WIRE BLUE HOSE</b>			
8.928-973.0	50' x 3/8" ID	6000	18.0
8.928-974.0	100' x 3/8" ID	6000	33.0

**HOSE - A+ / TUFF-FLEX - 1-WIRE SMOOTH COVER**



- Temperature: 250°F
- 50% Greater Flexibility

- 3/8" MPT Swivel x 3/8" MPT Solid
- Smooth impression, maximum oil-resistant tube and cover



PART NO.	LENGTH	WORKING PSI	APPROX WT (LBS.)
<b>3/8" TUFF-FLEX 1-WIRE BLUE HOSE</b>			
8.921-149.0	25' x 3/8" ID	4000	6.0
8.921-150.0	50' x 3/8" ID	4000	11.0
8.921-151.0	75' x 3/8" ID	4000	17.0
8.921-152.0	100' x 3/8" ID	4000	23.0
8.753-316.0	600' Reel*	4000	138.0

\*Please contact your sales rep to place a bulk hose (reel) order. Full reel will be priced by the foot. These reels are various sizes approximately 600' with a max of 3 incremental cuts, industry standard.

**HOSE - A+ / TUFF-FLEX - 2-WIRE SMOOTH COVER**



- Temperature: 250°F
- 50% Greater Flexibility

- 3/8" MPT Swivel x 3/8" MPT Solid
- Smooth impression, maximum oil-resistant tube and cover



PART NO.	LENGTH	WORKING PSI	APPROX WT (LBS.)
<b>3/8" TUFF-FLEX 2-WIRE BLUE HOSE</b>			
8.921-153.0	25' x 3/8" ID	6000	9.0
8.921-154.0	50' x 3/8" ID	6000	18.0
8.921-155.0	75' x 3/8" ID	6000	24.0
8.921-156.0	100' x 3/8" ID	6000	33.0
8.753-319.0	600' Reel*	6000	198.0

\*Please contact your sales rep to place a bulk hose (reel) order. Full reel will be priced by the foot. These reels are various sizes approximately 600' with a max of 3 incremental cuts, industry standard.

## PRESSURE LOOP - 2-WIRE

The 1/4" ID pressure lines solid / swivel for most any application. The 3/8" ID pressure loops have 1/2" female JIC swivels on both ends for typical unloader connection hose.



- 1/4" ID Pressure Loop
- 1/4" ID Two-Wire, 6000 PSI
- 1/4" MPT Swivel x 1/4" MPT Solid
- Temperature: 250°F

PART NO.	LENGTH	PSI
<b>1/4" PRESSURE LOOP</b>		
8.918-180.0	16" x 1/4" ID	6000
8.918-181.0	20" x 1/4" ID	6000
8.918-182.0	26" x 1/4" ID	6000
8.918-183.0	28" x 1/4" ID	6000
8.918-184.0	30" x 1/4" ID	6000
8.918-419.0	36" x 1/4" ID	6000
8.918-187.0	42" x 1/4" ID	6000



- JIC Pressure Loop
- 1/2" ID 5000 PSI
- 1/2" Female JIC Swivels - Each End
- Temperatures: 250°F (3/8" Pressure Loop) 275°F (1/2" Pressure Loop)
- 3/8" ID Two-Wire, 6000 PSI

PART NO.	LENGTH	PSI
<b>3/8" JIC PRESSURE LOOP</b>		
8.918-210.0	16" x 3/8" ID	6000
8.918-422.0	20" x 3/8" ID	6000
8.918-423.0	22" x 3/8" ID	6000
8.918-424.0	25" x 3/8" ID	6000
8.918-425.0	29" x 3/8" ID	6000
8.918-426.0	32" x 3/8" ID	6000
8.918-427.0	36" x 3/8" ID	6000
8.918-212.0	42" x 3/8" ID	6000
<b>1/2" JIC PRESSURE LOOP</b>		
8.918-224.0	20" x 1/2" ID	5000
8.918-225.0	28" x 1/2" ID	5000
8.918-228.0	46" x 1/2" ID	5000
8.918-230.0	70" x 1/2" ID	5000

## HOSE - WHITEWATER® COMBINATION STEAM HOSE



Good up to 3000 PSI - 250°F or 2500 PSI - 325°F



- Single High-Tensile Steel Wire Braid
- High Temperature Bend Restrictors - Both Ends
- Seamless Innertube
- Solid 3/8" or 1/2" MPT Connectors - Both Ends (Swivel Ends NOT Available)
- Oil-Resistant Cover

PART NO.	LENGTH	WORKING PSI
<b>3/8" STEAM HOSE</b>		
8.901-598.0	25'	3000
8.901-601.0	50'	3000
8.901-603.0	75'	3000
8.901-604.0	100'	3000
8.930-657.0	200'	3000
8.705-643.0*	500' Reel	3000
<b>1/2" STEAM HOSE</b>		
8.901-721.0	25'	2500
8.901-723.0	50'	2500
8.901-724.0	75'	2500
8.901-725.0	100'	2500
8.705-678.0*	500' Reel	2500

\*Full Reel - 500 ft per reel, hose only. Max of 3 incremental cuts, industry standard.

## HOSE BEND RESTRICTORS



- Temperature: 325°F
- Used on Hose Assemblies
- Non-Slip Sure Fit
- Easy Installation
- Top-Quality Molded Fit Bend Restrictors
- Fits snugly to prevent kinks near the connectors
- Insulated Rubber

PART NO.	LENGTH	COLOR
<b>1 WIRE</b>		
8.705-479.0	5.3" x 1/4"	Black Vinyl
8.705-476.0	6.0" x 1/2"	Black Vinyl
8.740-104.0	24.0" x 3/8"	Black Vinyl
8.756-784.0	6.0" x 3/8"	Black Vinyl
<b>2 WIRE</b>		
8.756-735.0	1/2" x 8"	Red Vinyl
8.705-478.0	6.0" x 3/8"	Red Vinyl
8.711-846.0	24.0" x 3/8"	Red Vinyl
8.705-480.0	7.0" x 3/8"	Red Vinyl
<b>COMBO - HIGH TEMP</b>		
8.705-483.0	6.5" x 3/8" ID	Gray Vinyl
8.705-482.0	6.5" x 1/2" ID	Black Rubber

**PULSE HOSE**



- PSI Working Pressure: 1300
- 3/8" MPT On Both Styles
- Available with either plug-end or open-flow with solid / swivel connects

PART NO.	LENGTH	DESCRIPTION
8.711-151.0	18"	with Plug End, Working PSI: 1300 PSI
8.711-153.0	24"	with Plug End, Working PSI: 1300 PSI
8.711-155.0	28"	Solid / Swivel - Open, Working PSI: 1300 PSI
8.711-157.0	36"	Solid / Swivel - Open, Working PSI: 1300 PSI

**HOBBY HOSE**

Replacement hose for most hobby pressure washers sold by retailers.



- PSI Working Pressure: 2250
- PSI Burst Pressure: 9000
- Thermoplastic Cover
- Fiber-braid Reinforcement
- M22 x 1.5 Fitting Inlet
- 14 mm Seal Cone Fits Generac, Excell and Kärcher
- 15 mm Seal Cone Fits Campbell, MI-T-M

PART NO.	LENGTH	SEAL CONE	ID
8.705-485.0	25'	14mm	1/4"
8.705-487.0	25'	15mm	1/4"
8.753-423.0	25'	22mm	1/4"

**GARDEN HOSE - APEX QUALITY**



The essential product for pressure washing

- Rated For Cold-Water Use
- Assemblies Complete With Bend Restrictor
- 5/8" or Larger ID For Full Flow
- Choice of Commercial or Heavy-Duty Grade
- Reinforced hose for flexibility and strength in all weather
- Commercial grade has machined octagonal "wrench tight" fittings

PART NO.	LENGTH	GRADE	COLOR
8.704-786.0	50' x 5/8" ID	Com	Gray
8.704-787.0	100' x 5/8" ID	Com	Gray
8.704-788.0	50' x 5/8" ID	HD	Light Green
8.704-789.0	100' x 5/8" ID	HD	Light Green

**ALL RUBBER REINFORCED HOT WATER HOSE - 160°F**

8.704-790.0	50' x 5/8" ID	Com	Red
8.704-791.0	50' x 3/4" ID	Com	Red

See page 180 for garden hose fittings

**GARDEN HOSE - COLD WEATHER**



- High-Quality Brass Fittings
- Heated Hose with 110 Plug
- Thermostatically controlled - heating element is activated at +/- 35°F temperature and turned off at +/- 40°F ambient temperature
- Use only with a UL approved GFCI outlet or extension
- PVC material FDA-approved for potable water
- Ideal for outdoor contractors
- 5/8" x 50 ft

PART NO.	LENGTH	DESCRIPTION
8.749-944.0	5/8" x 50'	Cold Weather Garden Hose

See page 180 for garden hose fittings

**AG HOSE - ORANGE PVC-RIBBED - BULK**

Braid-reinforced PVC hose designed specifically for AG / Pest Control and Lawn Spraying applications.

- Max PSI: 600
- Max Temperature: 160°F
- Color: Orange
- Tough Ribbed Cover
- Bulk hose standard in 300' single length coils
- Resists Abrasion and UV Rays
- Does Not Include Ends or Bend Restrictors

PART NO.	LENGTH	PSI
<b>3/8" HOSE - ORANGE</b>		
8.705-527.0	300' Coil, Single, Uncut Length	600
8.901-384.0	50' Bulk	600
8.901-385.0	100' Bulk	600
<b>1/2" HOSE - ORANGE</b>		
8.705-523.0	300' Coil, Single, Uncut Length	600
8.901-377.0	50' Bulk	600
8.901-379.0	100' Bulk	600
<b>3/4" HOSE - ORANGE</b>		
8.705-531.0	300' Coil Single, Uncut Length	600



### AG HOSE - COMPLETE ASSEMBLY

Braid-reinforced PVC hose designed specifically for AG / Pest control spraying applications. Assembled with ends or bend restrictors.



- Max PSI: 600
- Max Temperature: 160°F
- Color: Orange
- Tough Ribbed Cover
- Resists Abrasion and UV Rays
- Includes Ends and 8" Black Bend Restrictors on Each End

PART NO.	LENGTH	DESCRIPTION
8.928-576.0	3/8" x 100'	SO x SW
8.928-577.0	3/8" x 100'	SW x SW
8.928-578.0	3/8" x 50'	SO x SW
8.928-579.0	1/2" x 50'	SO x SW
8.928-580.0	1/2" x 100'	SO x SW
8.928-581.0	1/2" x 300'	SO x SW

### TUBING - CLEAR REINFORCED PVC

Multi-use, industrial-grade tubing with high-resistance to chemicals, solvents and fuel.



- Reinforced With Polyester Cord
- Huge Selection of Sizes and Lengths
- 4-to-1 Burst Safety Factor

PART NO.	ID X OD	WP AT 70°F	LENGTH
8.901-256.0	1/4" x 3/8"	250	25'
8.901-257.0	1/4" x 3/8"	250	50'
8.704-751.0	1/4" x 3/8"	250	100'
8.704-752.0	1/4" x 3/8"	250	300'
8.901-260.0	3/8" x 1/2"	175	25'
8.901-261.0	3/8" x 1/2"	175	50'
8.901-262.0	3/8" x 1/2"	175	100'
8.704-753.0	3/8" x 1/2"	175	300'
8.901-264.0	1/2" x 3/4"	175	25'
8.901-265.0	1/2" x 3/4"	175	50'
8.704-754.0	1/2" x 3/4"	175	100'
8.704-755.0	1/2" x 3/4"	175	300'
8.901-267.0	5/8" x 7/8"	175	25'
8.901-268.0	5/8" x 7/8"	140	50'
8.901-269.0	5/8" x 7/8"	140	100'
8.704-756.0	5/8" x 7/8"	140	300'
8.901-271.0	3/4" x 1"	140	25'
8.901-272.0	3/4" x 1"	140	50'
8.704-757.0	3/4" x 1"	140	100'
8.704-758.0	3/4" x 1"	140	300'
8.901-273.0	1" x 1-1/4"	75	25'
8.901-274.0	1" x 1-1/4"	75	50'
8.901-275.0	1" x 1-1/4"	75	100'
8.704-759.0	1" x 1-1/4"	75	200'

See page 181 for hose clamps

Specifications, product descriptions, product availability, and pricing subject to change without notice.

### CRIMP FITTINGS



PART NO.	SIZE	HOSE
8.724-027.0	3/8" MPT, Solid	3/8"
8.724-028.0	3/8" MPT, Swivel	3/8"
8.724-029.0	1/2" FJIC, Solid	3/8"
8.706-759.0	3/8" FPT, Swivel	3/8"

### COUPLINGS - FIELD ATTACHABLE

Designed and build your own hose or adapt and repair hose in the field (no crimper required).



PART NO.	ID X MPT
<b>1-WIRE BRAID HOSE COUPLINGS</b>	
8.705-493.0	1/4" x 1/4", Solid
8.705-495.0	1/4" x 1/4", Swivel
8.705-496.0	3/8" x 1/4", Solid
8.705-497.0	3/8" x 3/8", Solid
8.705-498.0	3/8" x 3/8", Swivel
8.705-499.0	1/2" x 3/8", Solid
8.705-500.0	1/2" x 1/2", Solid
8.705-501.0	1/2" x 1/2", Swivel
<b>2-WIRE BRAID HOSE COUPLINGS</b>	
8.705-502.0	1/4" x 1/4", Solid
8.705-503.0	1/4" x 1/4", Swivel
8.705-505.0	3/8" x 3/8", Solid
8.705-506.0	3/8" x 3/8", Swivel
8.705-507.0	1/2" x 1/2", Solid
8.705-508.0	1/2" x 1/2", Swivel

**TUBING - CLEAR PVC**



- "Box Pak" 100 ft
- Temperature: 25°F to 150°F
- Very Flexible, Non-Reinforced
- Self-dispensing Box Packaging

PART NO.	ID X OD	WP AT 70°F
8.901-279.0	1/4" x 3/8"	55
8.704-766.0	1/2" x 5/8"	30

**TUBING - HEAVY-DUTY VINYL**

This clear vinyl tubing is heavier duty than the rest! Thick wall resists kinking. Available in clear or clear-reinforced polyester braid. Comes in 1/4" & 3/8" ID x 1/2" OD.



- Very Flexible
- 100' Rolls
- Temperature: -10 to 150°F

PART NO.	ID X OD	PSI	DESCRIPTION
9.113-131.0	1/4" x 1/2"	50	Clear Vinyl
9.113-132.0	1/4" x 1/2"	250	Braided Vinyl
9.113-133.0	3/8" x 1/2"	100	Clear Vinyl

**CONNECTOR HOSE - 2' - 10'**

Hose come with One Solid x One Swivel MPT crimp fitting on each end.



- PSI: 4000 - 6000

- Temperatures:  
250°F (1/4" & 3/8" Connector Hoses)  
275°F (1/2" Connector Hose)

PART NO.	LENGTH	PSI	HOSE COLOR
<b>3/8" ULTIMA - 1-WIRE WITHOUT BEND RESTRICTORS</b>			
8.918-253.0	2'	4000	Black
8.918-255.0	3'	4000	Black
8.918-257.0	4'	4000	Black
8.918-259.0	5'	4000	Black
8.918-261.0	6'	4000	Black
8.918-263.0	7'	4000	Black
8.918-265.0	8'	4000	Black
8.918-267.0	9'	4000	Black
8.918-269.0	10'	4000	Black
<b>1/4" ULTIMA - 1-WIRE WITHOUT BEND RESTRICTORS</b>			
8.918-240.0	2'	4000	Black
8.918-241.0	3'	4000	Black
8.918-242.0	4'	4000	Black
8.918-243.0	5'	4000	Black
8.918-245.0	6'	4000	Black

PART NO.	LENGTH	PSI	HOSE COLOR
<b>3/8" ULTIMA - 2-WIRE - WITHOUT BEND RESTRICTORS</b>			
8.918-271.0	2'	6000	Black
8.918-273.0	3'	6000	Black
8.918-276.0	4'	6000	Black
8.918-278.0	5'	6000	Black
8.918-280.0	6'	6000	Black
8.918-282.0	7'	6000	Black
8.918-284.0	8'	6000	Black
8.918-420.0	9'	6000	Black
8.918-288.0	10'	6000	Black
<b>3/8" ULTIMA - 2-WIRE - WITH BEND RESTRICTORS</b>			
8.918-272.0	2'	6000	Black
8.918-275.0	3'	6000	Black
8.918-277.0	4'	6000	Black
8.918-209.0	5'	6000	Black
8.918-281.0	6'	6000	Black
8.918-283.0	7'	6000	Black
8.918-285.0	8'	6000	Black
8.918-287.0	9'	6000	Black
8.918-289.0	10'	6000	Black
<b>1/2" ULTIMA - 2-WIRE - WITHOUT BEND RESTRICTORS</b>			
8.918-292.0	2'	5000	Black
8.918-294.0	3'	5000	Black
8.918-296.0	4'	5000	Black
8.918-298.0	5'	5000	Black
8.918-300.0	6'	5000	Black
8.918-301.0	7'	5000	Black
8.918-302.0	8'	5000	Black
8.918-303.0	9'	5000	Black
8.918-304.0	10'	5000	Black

## FLEX LINE BYPASS / SUPPLY LINE HOSE

This industrial PVC hose looks and feels like rubber and has a black seamless inner tube. The tough abrasion resistant outer cover is polyester braid reinforced and as a burst rate of three times the rated working pressure.



- Reinforced Tough Outer Cover
- Excellent for Use as Supply Lines or Bypass

PART NO.	ID X OD	WP AT 70°F	LENGTH
<b>RED COVER, HEAVY WALL</b>			
8.901-281.0	3/8" x .634"	300	50'
8.704-762.0	3/8" x .634"	300	500'
8.901-282.0	1/2" x .792"	250	50'
8.704-764.0	1/2" x .792"	250	500'
8.901-284.0	3/4" x 1.14"	160	50'
8.704-765.0	3/4" x 1.14"	160	300'
<b>RED COVER- STANDARD WALL</b>			
9.106-578.0	1/4"	160	500'
<b>BLUE COVER, STANDARD WALL</b>			
8.704-779.0	1/4"	250	475'

## CONNECTOR HOSE

Hose comes with solid MPT crimp fittings on both ends.

PART NO.	LENGTH	PSI
<b>3/8" ULTIMA - 1-WIRE WITHOUT BEND RESTRICTORS</b>		
8.918-333.0	12'	4000
8.918-334.0	13'	4000
8.918-338.0	15'	4000
8.918-340.0	16'	4000
8.918-342.0	17'	4000
8.918-344.0	18'	4000
8.918-348.0	20'	4000
<b>3/8" ULTIMA - 1-WIRE WITH BEND RESTRICTORS ONE END</b>		
8.919-123.0	12'	4000
8.918-335.0	13'	4000
8.918-339.0	15'	4000
8.918-349.0	20'	4000
<b>1/4" BLUE - 1-WIRE WITHOUT BEND RESTRICTORS</b>		
8.918-389.0	13'	3000
8.918-391.0	14'	3000
8.918-393.0	15'	3000
8.918-395.0	16'	3000
8.918-397.0	17'	3000
8.918-399.0	18'	3000
8.918-401.0	19'	3000
8.918-403.0	20'	3000
8.918-409.0	23'	3000
8.918-411.0	24'	3000
8.918-413.0	25'	3000

PART NO.	LENGTH	PSI
<b>3/8" BLUE - 1-WIRE WITHOUT BEND RESTRICTORS</b>		
8.918-360.0	12'	3000
8.918-366.0	15'	3000
8.919-124.0	16'	3000
8.918-369.0	17'	3000
8.918-371.0	18'	3000
8.918-375.0	20'	3000
<b>3/8" BLUE - 1-WIRE WITH BEND RESTRICTORS ONE END</b>		
8.918-367.0	15'	3000
8.918-368.0	16'	3000
8.918-372.0	18'	3000
8.918-376.0	20'	3000
<b>1/4" BLUE - 1-WIRE WITH BEND RESTRICTORS ONE END</b>		
8.918-388.0	12'	3000
8.918-390.0	13'	3000
8.918-392.0	14'	3000
8.918-404.0	20'	3000

**SEWER HOSE**

Super Flexible Sewer Line Hose. Hose and couplings have small outside diameter, allowing hose and nozzles to fit through sewer line. Sewer line has Super Tough polyether cover over ultra-flexible nylon tube. 1/8" sewer nozzle and hose will operate through many 1-1/2" lines.

- Temperature: 160°F
- Nylon Tube
- 1.5 GPM Optimum Flow 1/8"  
2.5 GPM Optimum Flow 1/4"
- Ideal for cleaning lateral lines, drains & tanks
- Thermoplastic Polyurethane black cover that is oil, weather, ozone, and abrasion resistant
- Nozzles Not Included



PART NO.	DESCRIPTION
<b>1/8" HOSE - 4800 PSI, 1/4" INLET, 1/8" OUTLET</b>	
8.705-601.0	1/8" x 25'
8.705-602.0	1/8" x 50'
8.705-603.0	1/8" x 100'
<b>1/4" HOSE - 2600 PSI, 1/4" INLET, 1/4" OUTLET</b>	
8.705-607.0	1/4" x 50'
8.705-608.0	1/4" x 100'
<b>1/4" HOSE - 4400 PSI, 1/4" INLET, 1/4" OUTLET</b>	
8.705-610.0	1/4" x 50'
8.705-611.0	1/4" x 100'
8.705-613.0	1/4" x 200'

## Q.C. SOCKETS & PLUGS - LEGACY - BRASS & STEEL

Brass Couplers, designed for 4000 PSI and extended durability. Affordable and rugged all in one.



- PSI Max: 4000
- Precision Brass Design
- Stainless-Steel Band for Increased Durability (Except 1/2")
- Unrestricted Free-Flow

PART NO.	DESCRIPTION
9.802-164.0	1/4" FPT Brass Socket
9.802-166.0	3/8" FPT Brass Socket
8.707-166.0	1/2" FPT Brass Socket
9.802-165.0	1/4" MPT Brass Socket
9.802-169.0	3/8" MPT Brass Socket
8.707-167.0	1/2" MPT Brass Socket

Steel Nipples, hardened steel combined with zinc yellow chromate plating holds up to the harshest environments.



- PSI Max: 4000
- Zinc-Plated
- Hardened Steel

PART NO.	DESCRIPTION
8.707-136.0	1/4" FPT Steel Plug
9.802-170.0	3/8" FPT Steel Plug
8.707-165.0	1/2" FPT Steel Plug
8.707-139.0	1/4" MPT Steel Plug
9.802-171.0	3/8" MPT Steel Plug
8.707-164.0	1/2" MPT Steel Plug

## Q.C. SOCKETS & PLUGS - LEGACY - STAINLESS-STEEL



- PSI: 6000
- 303 Stainless-Steel
- Chemical-Resistant

PART NO.	DESCRIPTION
8.707-110.0	1/4" MPT Stainless-steel Socket
8.707-135.0	3/8" MPT Stainless-steel Socket
8.707-140.0	1/4" MPT Stainless-steel Plug
8.707-152.0	3/8" MPT Stainless-steel Plug
8.707-103.0	1/4" FPT Stainless-steel Socket
8.707-125.0	3/8" FPT Stainless-steel Socket
8.707-138.0	1/4" FPT Stainless-steel Plug
8.707-144.0	3/8" FPT Stainless-steel Plug
9.114-991.0	1/2" FPT Stainless-steel Socket
9.114-992.0	1/2" MPT Stainless-steel Socket

Specifications, product descriptions, product availability, and pricing subject to change without notice.

## O-RINGS

O-Rings for Legacy, AP, Hansen, Foster, Parker and quick-coupler brands.



- EPDM to 280°F
- Buna to 210°F
- Viton to 300°F

PART NO.	QC SIZE	BULK PART NO.*
<b>EPDM QC</b>		
8.701-981.0	1/8"	
9.802-098.0	1/4"	9.114-431.0*
9.802-102.0	3/8"	9.114-432.0*
<b>BUNA QC</b>		
8.702-015.0	1/4"	9.114-433.0*
8.702-017.0	3/8"	9.114-434.0*
8.702-021.0	1/2"	
<b>VITON QC</b>		
8.702-084.0	1/4"	9.114-435.0*
8.702-088.0	3/8"	9.114-436.0*
8.702-090.0	1/2"	

\*Pack of 1000

## Q.C. SOCKETS & PLUGS - FOSTER



- Precision Performance
- Unrestricted Bore for Free Flow
- Resists Plug Deformation When Pressure Spikes Occur and Withstands Pump Pulse
- Brass - 5200 PSI
- Steel & Stainless Steel - 5500 PSI

PART NO.	DESCRIPTION	TYPE
<b>SOCKETS</b>		
8.756-030.0	1/4" Male	Brass
8.756-031.0	1/4" Female	Brass
8.756-032.0	3/8" Male	Brass
8.756-033.0	3/8" Female	Brass
8.756-034.0	1/2" Female	Brass
<b>PLUGS</b>		
8.756-035.0	1/4" Male	Steel
8.756-036.0	1/4" Female	Steel
8.756-037.0	3/8" Male	Steel
8.756-038.0	3/8" Female	Steel
8.756-039.0	3/8" Male	Stainless-steel
8.756-040.0	3/8" Female	Stainless-steel
8.756-041.0	1/2" Male	Steel
8.756-042.0	1/2" Female	Steel

**Q.C. SOCKETS & PLUGS - SNAPTITE SERIES**

SnapTite Quick Sockets and Plugs are precision-built for extreme high pressure.

- PSI Max: 11,000
- Temperature: -40°F to 205°F
- Zinc Chromate



PART NO.	DESCRIPTION	TYPE
<b>SOCKET</b>		
8.707-115.0	1/4" FPT	Zinc Chromate
8.707-116.0	1/4" MPT	Zinc Chromate
9.802-167.0	3/8" FPT	Zinc Chromate
<b>PLUG</b>		
8.707-117.0	1/4" FPT	Zinc Chromate
8.707-121.0	1/4" MPT	Zinc Chromate
9.802-168.0	3/8" FPT	Zinc Chromate
8.707-120.0	3/8" MPT	Zinc Chromate
<b>SEAL, U-PACK</b>		
9.804-043.0	1/4"	Zinc Chromate
8.706-712.0	3/8"	Zinc Chromate

**Q.C. SOCKETS & PLUGS - ST SERIES**

SERIES	STEEL PLUG	BRASS PLUG	STAINLESS-STEEL
	PSI	PSI	PSI
1/8"	2600	2500	4200
1/4"	5500	5200	6700
3/8"	3500	2700	6300
1/2"	2700	2200	3000
3/4"	1700	1700	1700

PART NO.	DESCRIPTION	TYPE
<b>SOCKETS</b>		
8.709-436.0	1/8" MPT	Brass
8.709-463.0	3/4" MPT	Brass
8.709-462.0	3/4" FPT	Brass
8.709-566.0	3/8" MPT	Stainless-steel
8.709-564.0	3/8" FPT	Stainless-steel
8.709-457.0	1/2" FPT	Stainless-steel
<b>PLUGS</b>		
8.709-478.0	1/8" MPT	Steel, Zinc-plated
8.709-479.0	1/8" FPT	Steel, Zinc-plated
8.709-502.0	3/4" MPT	Steel, Zinc-plated
8.709-509.0	3/4" FPT	Steel, Zinc-plated
8.709-486.0	1/4" MPT	Hardened Stainless-steel
8.709-488.0	1/4" FPT	Hardened Stainless-steel
8.709-480.0	1/2" MPT	Hardened Stainless-steel
8.709-481.0	1/2" FPT	Hardened Stainless-steel

### Q.C. SOCKETS & PLUGS - M22 - TWIST SEAL

Allows U.S. standard hose to connect to 22 mm European fittings.



- PSI Max: 4000
- GPM: 7.8
- Temperature Max: 302°F
- Internal O-Ring Seal
- Machined-brass Body
- High-Impact Plastic Knob
- Not Threaded

PART NO.	DESCRIPTION	TYPE
8.709-522.0	1/4" FPT	Machined-brass Body
8.709-530.0	3/8" FPT	Machined-brass Body
9.802-173.0	1/4" MPT	Machined-brass Body
8.709-526.0	3/8" MPT	Machined-brass Body

Plugs are made of heavy-duty machined-brass for a safe and leak-free connection.



PART NO.	DESCRIPTION	TYPE
8.709-540.0	1/4" FPT	Machined-brass Body
8.709-546.0	3/8" FPT	Machined-brass Body
8.709-536.0	1/4" MPT	Machined-brass Body
8.707-185.0	3/8" MPT	Machined-brass Body
9.115-009.0	M22 X M22	Machined Brass body

### Q.C. SOCKETS & PLUGS - EXTENDED TWIST SEAL



- PSI: 3600
- GPM: 11
- Temperature: 300°F
- Double O-Ring Seal
- Machined-Brass Body
- High-Impact Plastic Knob

PART NO.	DESCRIPTION	PSI MAX
8.709-535.0	1/4" FPT x M22, Female, Coupler	3600
8.709-555.0	1/4" FPT x M22, Male, Plug	3600

### Q.C. SOCKETS & PLUGS - M22 - TWIST SEAL

Couples U.S. standard pipe threads to 22 mm European fittings found on imported pressure washers.



Sockets

- PSI Max: 4000, GPM: 7.8
- Temperature Max: 302°F
- 3.9 to 4.2 Oz. Weight
- Internal O-ring with back ring seal assures no-leak operation
- Oversized High-Impact Plastic Knob
- Machined-Brass Body

PART NO.	DESCRIPTION	TYPE
8.709-524.0	1/4" FPT	Machined-brass Body
8.709-531.0	3/8" FPT	Machined-brass Body
8.709-534.0	1/2" FPT	Machined-brass Body
8.709-521.0	1/4" MPT	Machined-brass Body
8.709-528.0	3/8" MPT	Machined-brass Body
8.709-533.0	1/2" MPT	Machined-brass Body



Plugs

PART NO.	DESCRIPTION	TYPE
8.709-548.0	3/8" FPT	Machined-brass Body
8.709-553.0	1/2" FPT	Machined-brass Body
8.709-539.0	1/4" MPT	Machined-brass Body
8.709-551.0	1/2" MPT	Machined-brass Body

### Q.C. SOCKETS & PLUGS- M22 - QUICK DISCONNECT



Part # 8.709-554.0

- PSI: 4000
- Temperature: 175°F
- EPDM O-Rings
- Machined-brass Body

PART NO.	DESCRIPTION
8.709-554.0	3/8" QC Coupler X M22 M
8.709-601.0	3/8" Plug X M22 F
9.114-604.0	3/8" QC Coupler X M22 F



O-Rings - M22, Viton

PART NO.	DESCRIPTION
8.704-036.0	O-rings, M22 Viton
8.704-037.0	Back Ring, 2.4 x 9.3
8.756-782.0	O-rings (EPDM)

**Q.C. SOCKETS & PLUGS - DOUBLE SHUT-OFF**



**8.709-580.0**



**8.709-556.0**

- Quick disconnect without drips and leaks
- Indispensable for in-plant multiple station systems
- Machined-construction brass, zinc-plated steel or stainless steel

PART NO.	DESCRIPTION	TYPE	PSI MAX
<b>SOCKETS</b>			
8.709-556.0	1/8" FPT	Brass	3000
8.756-043.0	1/4" FPT	Brass	2700
8.709-559.0	3/8" FPT	Brass	2200
8.709-560.0	1/2" FPT	Brass	2250
8.709-561.0	1/2" FPT	Stainless-steel	4250
8.709-562.0	3/4" FPT	Brass	2000
<b>PLUGS</b>			
8.709-580.0	1/8" FPT	Brass	3000
8.709-583.0	3/8" FPT	Brass	2200
8.756-044.0	1/4" FPT	Brass	2700
8.709-584.0	1/2" FPT	Brass	2250
8.709-582.0	3/8" FPT	Steel, Zinc	4000

**O-RING REPLACEMENTS**



Replacement O-Rings

- Nitrile Up to 210°F
- Use Viton for 230°F and Above

PART NO.	DESCRIPTION	TYPE	MAX TEMP
8.701-994.0	1/8" O-ring	Nitrile	Up To 210°F
8.702-015.0	1/4" O-ring	Nitrile	Up To 210°F
8.702-017.0	3/8" O-ring	Nitrile	Up To 210°F
8.702-021.0	1/2" O-ring	Nitrile	Up To 210°F
8.702-084.0	1/4" O-ring	Viton	230°F +
8.702-088.0	3/8" O-ring	Viton	230°F +
8.702-090.0	1/2" O-ring	Viton	230°F +
8.702-023.0	3/32" O-ring	Nitrile*	230°F +

\* For Kit 1

**Q.C. SOCKETS & PLUGS - A+ BRASS**

Designated for 4000 PSI and extended durability. EPDM O-rings as standard. Affordable and rugged all in one.



PART NO.	DESCRIPTION	PSI
8.750-695.0	1/4" Socket FPT	4000
8.750-696.0	1/4" Socket MPT	4000
8.750-697.0	3/8" Socket FPT	4000
8.750-698.0	3/8" Socket MPT	4000

**SWIVELS - 90°**

Excellent for car wash booms and hose reels. Remarkable value, comparable to best swivels made.



- PSI: 4000
- Temperature: 225°F
- Forged-Brass Body
- Nitrile O-Ring

PART NO.	DESCRIPTION	PSI MAX
8.712-460.0	3/8" M x 3/8" F	4000
8.712-461.0	3/8" F x 3/8" F	4000
8.712-462.0	1/2" M x 1/2" F	4000
8.712-463.0	1/2" F x 1/2" F	4000
8.712-464.0	1/2" M x 3/8" F	4000
8.712-469.0	3/8" F x 3/4" M w 3/8" Inside thread	4000
8.900-855.0	Repair Kit	4000

**SWIVELS - RIGHT ANGLE**



**8.712-449.0**

- PSI Max: 3000 (Brass)
- PSI Max: 5000 (Stainless-Steel)
- Temperature: 300°F
- 360° Swivel Rotation



**8.712-448.0**

PART NO.	DESCRIPTION	TYPE
8.712-448.0	3/8" Swivel	Stainless-steel
8.712-450.0	3/8" Swivel	Brass
8.712-449.0	1/2" Swivel	Brass
8.700-287.0	3/8" Repair Kit for 8.712-448.0, 8.712-450.0	
8.700-285.0	1/2" Repair Kit for 8.712-449.0	



## SWIVELS - STAINLESS-STEEL, HIGH-PRESSURE



Perfect for Hose to Trigger Gun Swivel connection



- GPM Max: 15
- MAX PSI: 5000
- Temperature: 250° F
- Viton Seals

PART NO.	DESCRIPTION	PSI
9.113-294.0	3/8 MPT X FPT	5000

## SWIVELS - STAINLESS-STEEL, HIGH-PRESSURE AND ECONOMY BRASS



- GPM Max:  
10.5 (Stainless-Steel)  
7.8 (Brass)
- Temperature:  
320°F (Stainless-Steel)  
195°F (Brass)
- Highly Resistant to Harsh Chemicals
- "Live" Swivel at Full Pressure
- Weight: 6 oz..

PART NO.	DESCRIPTION	PSI
8.712-456.0	1/4" M x F, Swivel - SS	5600
8.712-455.0	3/8" M x F, Swivel - SS	5600
8.712-443.0	3/8" M x F, Swivel - Brass	3600
8.704-096.0	Repair Kit for 8.712-456.0, 8.712-455.0	

## SWIVELS - GUN - MOSMATIC



Made of corrosion-resistant material and stainless-steel, self-lubricated bearings, the new gun swivel offers highest-quality Swiss-made craftsmanship.



- PSI: 4000
- Temperature: 250°F
- GPM: 30

PART NO.	DESCRIPTION
8.712-467.0	1/4" NPTF, Gun Swivel
8.712-466.0	3/8" NPTF, Gun Swivel

## SWIVELS - STAINLESS-STEEL BALL BEARING



- PSI Max: 3500
- Temperature: 180°F
- Hardened, Stainless-Steel Body
- Nitrile Buna Seals
- M x F NPT Thread
- Ball-bearing design ensures free swivel action under pressure
- Suitable for extended-wear applications

PART NO.	DESCRIPTION	GPM
8.712-457.0	1/4" Stainless-steel	6.8
8.712-458.0	3/8" Stainless-steel	10.6
8.712-459.0	1/2" Stainless-steel	27.0
8.700-459.0	Repair Kit for 8.712-458.0	
8.700-460.0	Repair Kit for 8.712-457.0	
8.700-461.0	Repair Kit for 8.712-459.0	

## SWIVELS - STAINLESS-STEEL



- PSI: 4000
- Temperature: 200°F
- All Stainless Construction
- Teflon® Swivel Ring
- Rebuildable
- 3/8" In and Out

PART NO.	DESCRIPTION
8.712-446.0	3/8" MPT x FPT
8.712-447.0	3/8" FPT x FPT
8.900-764.0	Seal Kit

## SWIVELS - BALL BEARING

Swivels freely even at maximum pressure level noted below.



8.712-438.0

8.712-479.0

- Brass and Stainless-steel Materials
- Inline & 90 Degree Options

PART NO.	DESCRIPTION	PSI MAX
<b>INLINE SWIVELS</b>		
8.712-438.0	1/4" MPT x FPT	2000
8.712-439.0	1/4" MPT x FPT	3500
8.712-440.0	3/8" MPT x FPT	2000
8.712-441.0	3/8" MPT x FPT	3500
<b>90° SWIVELS</b>		
8.712-479.0	1/4" 90°	3500
8.700-263.0	Rebuild Kit	

**SWIVELS - A+ LONG BODY STYLE**



- PSI: 3000
- Brass Housing
- Stainless-Steel Flow-Through Bolt
- Close-tolerance fit ensures leakproof seal
- Teflon® Ring Provides Free Swivel

PART NO.	DESCRIPTION	TYPE
8.904-551.0	3/8" MPT x FPT*	Brass
8.904-552.0	3/8" FPT x FPT*	Brass
8.900-764.0	Seal Kit	

\* Long Body Style

**ADAPTERS - BRASS**



- FPT X MPT

PART NO.	DESCRIPTION	TYPE
8.705-186.0	1/8" x 1/8"	Brass
9.803-054.0	1/4" x 1/8"	Brass
8.705-188.0	1/4" x 1/4"	Brass
8.705-185.0	3/8" x 1/8"	Brass
9.804-007.0	3/8" x 1/4"	Brass
8.705-190.0	3/8" x 3/8"	Brass
8.705-192.0	1/2" x 1/4"	Brass
8.705-191.0	1/2" x 3/8"	Brass
9.802-148.0	1/2" x 1/2"	Brass
8.705-194.0	3/4" x 1/2"	Brass
8.705-195.0	3/4" x 3/4"	Brass

**BUSHINGS - BRASS**



- FPT X MPT

PART NO.	DESCRIPTION	TYPE
9.803-564.0	1/4" x 1/8"	Brass
8.705-129.0	3/8" x 1/4"	Brass
9.804-015.0	3/8" x 1/8"	Brass
9.802-135.0	1/2" x 1/4"	Brass
8.705-132.0	1/2" x 3/8"	Brass
8.705-133.0	3/4" x 3/8"	Brass
9.802-136.0	3/4" x 1/2"	Brass

**HEX COUPLINGS - BRASS**



PART NO.	DESCRIPTION	TYPE
8.705-150.0	1/8" F	Brass
8.705-151.0	1/4" F	Brass
8.705-152.0	3/8" F	Brass
8.705-153.0	1/2" F	Brass
8.705-154.0	3/4" F	Brass

**HEX COUPLINGS - REDUCING - BRASS**



PART NO.	DESCRIPTION	TYPE
8.705-155.0	1/4" x 1/8" F	Brass
8.705-156.0	3/8" x 1/4" F	Brass
8.705-157.0	1/2" x 1/4" F	Brass
8.705-158.0	1/2" x 3/8" F	Brass
8.705-159.0	3/4" x 1/2" F	Brass

**HEX NIPPLES - DOUBLE - BRASS**



PART NO.	DESCRIPTION	TYPE
8.705-224.0	1/8" x 1/8" M	Brass
9.802-108.0	1/4" x 1/4" M	Brass
8.705-228.0	3/8" x 3/8" M	Brass
9.803-989.0	1/2" x 1/2" M	Brass
8.705-233.0	3/4" x 3/4" M	Brass
8.705-234.0	1" x 1" M	Brass

**HEX REDUCING NIPPLES - BRASS**



PART NO.	DESCRIPTION	TYPE
8.630-575.0	1/4" x 1/8" M	Brass
8.705-223.0	3/8" x 1/8" M	Brass
8.705-227.0	3/8" x 1/4" M	Brass
8.705-229.0	1/2" x 1/4" M	Brass
9.803-276.0	1/2" x 3/8" M	Brass
9.803-556.0	3/4" x 1/2" M	Brass

**NIPPLES - BRASS - OPEN & CLOSE**



Close Nipple



PART NO.	DESCRIPTION	TYPE
8.705-201.0	1/8" Close	Brass
8.705-204.0	1/4" Close	Brass
8.705-211.0	3/8" Close	Brass
9.802-109.0	1/2" Close	Brass
8.705-220.0	3/4" Close	Brass
8.705-202.0	1/8" x 1-1/2"	Brass
8.705-203.0	1/8" x 2-1/2"	Brass
8.705-205.0	1/4" x 1-1/2"	Brass
8.705-206.0	1/4" x 2"	Brass
8.705-207.0	1/4" x 2-1/2"	Brass
8.705-212.0	3/8" x 1-1/2"	Brass
8.705-213.0	3/8" x 2-1/2"	Brass
8.705-214.0	3/8" x 3"	Brass
8.705-217.0	1/2" x 1-1/2"	Brass
8.705-218.0	1/2" x 3"	Brass
8.705-221.0	3/4" x 2"	Brass
8.705-222.0	3/4" x 3"	Brass

**SWIVELS - JIC**



9.802-151.0

PART NO.	DESCRIPTION	TYPE
9.802-153.0	1/4" Barb x 1/4" JIC FPT	Brass
9.802-151.0	1/2" Barb x 1/2" JIC FPT	Brass
9.802-152.0	3/4" Barb x 3/4" JIC FPT	Brass
9.802-048.0	1/2" JIC FPT x 3/8" MPT	Steel
8.706-315.0	1/2" JIC FPT x 1/2" MPT	Steel

**NIPPLES - JIC X-PIPE**



PART NO.	DESCRIPTION
8.706-265.0	1/2" JIC x 1/4" FPT
9.802-037.0	1/2" JIC x 3/8" FPT
9.802-036.0	1/2" JIC x 3/8" MPT
9.802-038.0	1/2" JIC x 1/2" MPT

**ELBOWS - 90° - BRASS**



PART NO.	DESCRIPTION	TYPE
8.705-160.0	1/8" FPT	Brass
8.705-161.0	1/4" FPT	Brass
9.802-113.0	3/8" FPT	Brass
9.803-265.0	1/2" FPT	Brass
8.705-164.0	3/4" FPT	Brass
8.705-169.0	1/4" x 1/4" MPT	Brass
8.705-171.0	3/8" x 3/8" MPT	Brass
8.705-173.0	1/2" x 1/2" MPT	Brass
9.802-129.0	1/2" JIC x 3/8" MPT	Brass
9.802-131.0	1/2" JIC x 1/2" MPT	Brass

**REDUCING ELBOWS**

8.705-165.0	1/4" FPT x 1/8" FPT	Brass
8.705-166.0	3/8" FPT x 1/4" FPT	Brass
8.705-168.0	1/4" x 1/8" MPT	Brass
8.705-167.0	3/8" x 1/8" MPT	Brass
8.705-170.0	3/8" x 1/4" MPT	Brass
8.705-172.0	1/2" x 3/8" MPT	Brass

**ELBOWS - STREET-BRASS**



PART NO.	DESCRIPTION	TYPE
<b>90° STREET ELBOWS</b>		
8.705-174.0	1/8" M x F	Brass
9.803-839.0	1/4" M x F	Brass
9.802-114.0	3/8" M x F	Brass
9.802-115.0	1/2" M x F	Brass
9.803-555.0	3/4" M x F	Brass
<b>45° STREET ELBOWS</b>		
8.705-180.0	1/8" M x F	Brass
8.705-181.0	1/4" M x F	Brass
8.705-182.0	3/8" M x F	Brass
8.705-183.0	1/2" M x F	Brass
8.705-184.0	3/4" M x F	Brass

**TEES - FPT - FORGED-BRASS**



PART NO.	DESCRIPTION	TYPE
8.705-246.0	1/8" F	Brass
8.705-247.0	1/4" F	Brass
8.705-248.0	3/8" F	Brass
9.802-117.0	1/2" F	Brass
8.705-251.0	3/4" F	Brass

**TEES - BRANCH-BRASS**



■ FPT x FPT x MPT Pipe Run

PART NO.	DESCRIPTION	TYPE
9.802-120.0	1/4"	Brass
8.705-254.0	3/8"	Brass
8.705-255.0	1/2"	Brass

**TEES - STREET-BRASS**



■ FPT x FPT x MPT Pipe Run

PART NO.	DESCRIPTION	TYPE
9.802-121.0	1/4"	Brass
8.705-257.0	3/8"	Brass
9.802-122.0	1/2"	Brass
8.705-259.0	3/4"	Brass

**CROSSES - FPT - BRASS EXTRUDED**



PART NO.	DESCRIPTION	TYPE
8.705-196.0	1/4"	Brass
8.705-197.0	3/8"	Brass
8.705-198.0	1/2"	Brass
8.705-199.0	3/4"	Brass

**NIPPLES - JIC - BRASS**



9.802-128.0



8.706-894.0

PART NO.	DESCRIPTION	TYPE
8.706-872.0	1/2" JIC x 1/4" MPT	Brass
9.802-127.0	1/2" JIC x 3/8" MPT	Brass
9.802-128.0	1/2" JIC x 1/2" MPT	Brass
8.706-877.0	1/2" JIC x 3/4" MPT	Brass
8.706-894.0	1/2" JIC x 1/2" FPT	Brass
8.706-895.0	1/2" JIC x 3/8" FPT	Brass
8.706-896.0	1/2" JIC x 1/4" FPT	Brass
8.706-897.0	1/2" JIC x 3/4" FPT	Brass
8.706-899.0	3/4" JIC x 3/4" Pipe MPT	Brass
8.706-971.0	1/2" JIC x 3/4" GHF	Brass

**BARBS - PUSH-N-LOCK**



Normally requires no clamps



Barb x Barb

PART NO.	DESCRIPTION	TYPE
<b>BARB X MPT</b>		
8.705-069.0	1/4" x 1/8"	Brass
8.705-070.0	1/4" x 1/4"	Brass
8.705-071.0	1/4" x 3/8"	Brass
8.705-072.0	3/8" x 1/8"	Brass
8.705-073.0	3/8" x 1/4"	Brass
8.705-074.0	3/8" x 3/8"	Brass
8.705-075.0	3/8" x 1/2"	Brass
8.705-076.0	3/8" x 3/4"	Brass
8.705-077.0	1/2" x 1/4"	Brass
9.802-156.0	1/2" x 3/8"	Brass
8.705-079.0	1/2" x 1/2"	Brass
8.705-080.0	1/2" x 3/4"	Brass
8.705-081.0	5/8" x 3/8"	Brass
8.705-082.0	5/8" x 1/2"	Brass
8.705-083.0	5/8" x 3/4"	Brass
8.705-084.0	3/4" x 1/2"	Brass
8.705-085.0	3/4" x 3/4"	Brass
<b>BARB X BARB</b>		
8.705-064.0	1/4" x 1/4"	Brass
8.705-065.0	3/8" x 3/8"	Brass
8.705-066.0	1/2" x 1/2"	Brass
8.705-067.0	5/8" x 5/8"	Brass
8.705-068.0	3/4" x 3/4"	Brass

### HOSE BARBS - BRASS CHECK BARBS



- 1/4" MPT x 1/4" Barb
- Brass Body
- Buna or Viton Check Ball

PART NO.	DESCRIPTION	TYPE
8.904-389.0	Check Hose Barb - Viton	Brass Body
8.904-390.0	Check Hose Barb - Buna	Brass Body

### HOSE BARBS - SWIVEL - LOW PRESSURE

Swivels easily at low pressure to eliminate twists and tangles in chemical or water lines.



- PSI Max: 300
- Temperature: 210°F
- Brass MPT base with steel hose barb

PART NO.	DESCRIPTION	TYPE
8.705-050.0	1/4" x 1/4"	Brass MPT, Steel Hose Barb
8.705-052.0	3/8" x 3/8"	Brass MPT, Steel Hose Barb
8.705-053.0	1/2" x 1/2"	Brass MPT, Steel Hose Barb

### HOSE BARBS - ORIFICED

Inexpensive way to create suction on inlet side of pump



- 3/8" MPT x 5/8" Barb
- Used in-line from float tank to pump
- One-Piece, Machined-Brass
- Standard orifice 5/32" - drill up to 3/8" to fit your need

PART NO.	DESCRIPTION	TYPE
8.705-093.0	Orificed Hose Barb	Machined Brass

### DRAIN COCKS



PART NO.	DESCRIPTION
8.705-060.0	1/4" Fuel Drain with Tee Handle
8.705-061.0	1/4" Fuel Drain with Barb and Tee Handle

### HOSE BARBS - BRASS



90° Barb x MPT

- 90° Barb x MPT, Barb x MPT, & Barb x FPT



Barb x MPT

PART NO.	DESCRIPTION	TYPE
<b>90° BARB X MPT</b>		
8.802-142.0	1/4" x 1/8"	Brass
8.802-143.0	1/4" x 1/4"	Brass
8.705-118.0	3/8" x 1/4"	Brass
8.705-119.0	3/8" x 3/8"	Brass
8.705-120.0	3/8" x 1/2"	Brass
8.705-121.0	1/2" x 1/4"	Brass
8.705-122.0	1/2" x 3/8"	Brass
8.705-123.0	1/2" x 1/2"	Brass
8.705-125.0	5/8" x 3/8"	Brass
8.705-126.0	5/8" x 1/2"	Brass
<b>BARB X MPT</b>		
8.705-097.0	1/8" x 1/4"	Brass
8.802-137.0	1/4" x 1/8"	Brass
8.802-138.0	1/4" x 1/4"	Brass
8.705-102.0	1/4" x 3/8"	Brass
8.705-108.0	1/4" x 1/2"	Brass
8.705-098.0	3/8" x 1/8"	Brass
8.705-104.0	3/8" x 1/4"	Brass
8.705-105.0	3/8" x 3/8"	Brass
8.705-103.0	3/8" x 1/2"	Brass
8.705-100.0	3/8" x 3/4"	Brass
8.705-110.0	1/2" x 1/4"	Brass
8.705-106.0	1/2" x 3/8"	Brass
8.705-109.0	1/2" x 1/2"	Brass
8.705-111.0	1/2" x 3/4"	Brass
8.705-107.0	5/8" x 3/8"	Brass
8.802-140.0	5/8" x 1/2"	Brass
8.705-113.0	5/8" x 3/4"	Brass
8.705-114.0	3/4" x 1/2"	Brass
8.705-115.0	3/4" x 3/4"	Brass
<b>BARB X FPT</b>		
8.706-949.0	1/4" x 1/4"	Brass

**PLUGS - HEX HEAD**



PART NO.	DESCRIPTION
8.705-236.0	1/8"
8.705-238.0	1/4"
8.705-240.0	3/8"
9.803-673.0	1/2"
8.705-244.0	3/4"

**PLUGS - ALLEN HEAD**



PART NO.	DESCRIPTION
9.803-051.0	1/8"
9.802-124.0	1/4"
8.705-241.0	3/8"
8.705-243.0	1/2"

**LOCKNUT FITTINGS - HEX-HEAD PLUGS**



PART NO.	DESCRIPTION
8.705-041.0	1/8"
8.705-042.0	1/4"
8.705-043.0	3/8"
8.705-044.0	1/2"
8.705-045.0	3/4"

**GARDEN HOSE FITTINGS**



8.901-292.0



8.705-034.0

- MGH = Male Garden Hose
- FGH = Female Garden Hose
- Heavy-Duty, Machined-brass Fittings



8.709-460.0



9.804-016.0



9.802-145.0



8.705-087.0

PART NO.	DESCRIPTION
----------	-------------

**SWIVEL FITTINGS - 3/4" FGH**

8.705-032.0	1/4" MPT
8.901-292.0	3/8" MPT
8.901-291.0	1/2" MPT
8.705-033.0	1/2" FPT (S-1)
9.802-146.0	3/4" FGH Swivel with 1/2" MPT Strainer
8.705-034.0	3/4" FPT (S-2)
8.705-035.0	3/4" FGH (S-3)
8.705-008.0	1/2" Barb
8.705-009.0	5/8" Barb
8.705-010.0	3/4" Barb

**GARDEN HOSE QUICK COUPLERS**

8.709-460.0	Female Hose Coupler
8.709-508.0	Male Hose Plug

**GARDEN HOSE ACCESSORIES**

8.705-016.0	Garden Hose Washer
9.804-016.0	Filter Screen Washer (30-mesh)

**SOLID FITTINGS**

8.705-024.0	3/4" MGH x 3/8" MPT
9.802-145.0	3/4" MGH x 1/2" MPT
8.705-026.0	3/4" MGH x 3/4" MPT
8.705-019.0	3/4" FGH x 1/2" FPT
8.705-020.0	3/4" FGH x 3/4" FPT
8.705-022.0	3/4" FGH x 1/2" MPT
8.705-023.0	3/4" FGH x 3/4" MPT
8.705-018.0	3/4" FGH x 3/4" FGH (Stainless-steel)

**HOSE BARB FITTINGS**

8.705-086.0	3/8" Barb x 3/4" MGH
8.705-087.0	1/2" Barb x 3/4" MGH
8.705-088.0	5/8" Barb x 3/4" MGH
8.705-089.0	3/4" Barb x 3/4" MGH
8.705-091.0	3/8" Barb x 3/4" FGH
8.705-092.0	1/2" Barb x 3/4" FGH
8.705-094.0	5/8" Barb x 3/4" FGH
8.705-095.0	3/4" Barb x 3/4" FGH

## HOSE CLAMPS

WARNING: LOW-PRESSURE USE ONLY!



- Not for Use on Pressure Washer Discharge Hose
- Stainless-Steel Band and Housing
- Screw Clamp - Gear Tensions



- Nylon "Speedi-Clamp" Tightens with a Snap
- Releases with a Twist
- Pack of 50

PART NO.	BAND	OD	MIN	MAX
<b>SCREW CLAMPS</b>				
9.802-200.0	4 mm	5/16"	.25	.63
8.710-456.0	5 mm	5/16"	.38	.88
8.710-457.0	10 mm	5/16"	.50	1.06
8.710-458.0	H8	1/2"	.44	.91
8.710-459.0	H10	1/2"	.56	1.06
8.710-460.0	H12	1/2"	.69	1.25
8.710-461.0	H16	1/2"	.7	1.50
8.710-464.0	H32	1/2"	1.56	2.50
6.390-126.0	Red Spring Clamp		.466	.54
8.709-116.0	Green Spring Clamp		.40	.48
<b>SPEEDI-CLAMPS - PACKS OF 50</b>				
8.904-167.0	1/4" ID Speedi-Clamp			
8.904-168.0	3/8" ID Speedi-Clamp			

## ADAPTERS - HIGH PSI - STEEL



- MPT x FPT

PART NO.	DESCRIPTION	PSI	TYPE
8.705-356.0	1/4" x 1/4"	6000	Steel
8.705-357.0	1/4" x 3/8"	6000	Steel
9.804-553.0	3/8" x 3/8"	6000	Steel
8.706-302.0	3/8" x 1/2"	6000	Steel
8.705-360.0	1/2" x 1/2"	6000	Steel
8.705-361.0	1/2" x 3/4"	6000	Steel
8.705-362.0	3/4" x 3/4"	6000	Steel

## COUPLINGS - HEX - HIGH PSI - STEEL

- Up to 6000 PSI Working Pressure (18,000 PSI Burst)
- Attractive Zinc-Plated Protective Coating
- U.S. Standard Taper Pipe Threads

## COUPLINGS - HEX - HEAVY WALL STEEL



- FPT x FPT

PART NO.	DESCRIPTION	PSI
<b>HEX COUPLINGS</b>		
8.705-364.0	1/4" x 1/4"	6000
8.705-366.0	3/8" x 3/8"	6000
8.706-141.0	1/2" x 1/2"	5000
8.705-371.0	3/4" x 3/4"	5000
<b>REDUCING COUPLINGS</b>		
8.705-365.0	3/8" x 1/4"	6000
8.705-367.0	1/2" x 3/8"	5000
8.705-368.0	1/2" x 1/4"	5000
8.705-370.0	3/4" x 1/2"	4000

## NIPPLES - HEX - HIGH PSI - STEEL



- MPT X MPT

PART NO.	DESCRIPTION	PSI
9.802-010.0	1/4" x 1/4"	6000
9.802-011.0	3/8" x 3/8"	6000
9.802-012.0	1/2" x 1/2"	6000
8.705-380.0	3/4" x 3/4"	6000
9.802-022.0	3/8" x 1/4"	6000
8.705-375.0	1/2" x 1/4"	6000
8.705-376.0	1/2" x 3/8"	6000
8.705-379.0	3/4" x 1/2"	6000

## ELBOWS - 45°



- FPT X FPT

PART NO.	DESCRIPTION
8.706-278.0	3/8" x 3/8", 45°
8.706-277.0	1/4" x 1/4", 45°

**ELBOWS - STREET - HIGH PSI - STEEL**



■ MPT x FPT

PART NO.	DESCRIPTION	PSI
9.802-029.0	1/4" x 1/4"	6000
9.804-080.0	1/4" x 3/8"	6000
9.802-030.0	3/8" x 3/8"	6000
8.705-384.0	3/8" x 1/2"	6000
9.803-045.0	1/2" x 1/2"	6000
8.705-386.0	1/2" x 3/4"	6000
8.705-387.0	3/4" x 3/4"	6000

**TEES - STREET TEE - HIGH PSI - STEEL**



■ FPT x FPT x MPT Pipe Run

PART NO.	DESCRIPTION	PSI
8.705-428.0	1/4"	5000
9.802-033.0	3/8"	4500
9.802-034.0	1/2"	3000
8.705-431.0	3/4"	3000

**ELBOWS - HIGH PSI - STEEL**



PART NO.	DESCRIPTION	PSI
8.706-176.0	1/4" x 1/8" FPT	4500
8.705-393.0	1/4" x 1/4" FPT	5000
8.705-394.0	1/4" x 3/8" FPT	4500
9.802-023.0	3/8" x 3/8" FPT	4500
8.705-396.0	3/8" x 1/2" FPT	3000
8.705-397.0	1/2" x 1/2" FPT	3000
8.705-398.0	1/2" x 3/4" FPT	4000
8.705-399.0	3/4" x 3/4" FPT	4000
9.802-039.0	1/2" JIC x 3/8" MPT	5000
9.802-040.0	1/2" JIC x 1/2" MPT	5000
9.802-130.0	1/2" JIC x 1/4" MPT	5000
8.706-906.0	1/2" JIC x 3/4" FPT	5000

**CROSSES - 4 CONNECTS - HIGH PSI - STEEL**



PART NO.	DESCRIPTION	PSI
8.705-418.0	1/4" FPT	5000
8.705-419.0	3/8" FPT	4500
8.705-420.0	1/2" FPT	3000
8.705-421.0	3/4" FPT	3000

**TEES - 3 CONNECTS - HIGH PSI - FORGED**



PART NO.	DESCRIPTION	PSI
8.705-412.0	1/4" FPT	5000
8.705-414.0	3/8" FPT	4500
8.706-216.0	1/2" FPT	3000
8.705-417.0	3/4" FPT	3000
8.706-213.0	1/4" MPT	5000

**REDUCING BUSHING - HIGH PSI - STEEL**



■ MPT x FPT

PART NO.	DESCRIPTION	PSI	TYPE
9.802-046.0	3/8" x 1/4"	6000	Steel
8.705-423.0	1/2" x 1/4"	6000	Steel
9.802-045.0	1/2" x 3/8"	6000	Steel
8.705-426.0	3/4" x 1/2"	6000	Steel

**HEX PIPE PLUGS - HIGH PSI - STEEL**



PART NO.	DESCRIPTION	PSI	TYPE
9.803-530.0	1/4" MPT	6000	Steel
8.705-433.0	3/8" MPT	6000	Steel
8.705-434.0	1/2" MPT	6000	Steel
8.705-435.0	3/4" MPT	6000	Steel



### GALVANIZED PIPE FITTINGS

- Pressed-Steel Fittings - external galvanized for excellent chemical resistance
- NOT recommended for high-pressure piping applications
- Ideal for supply line (city water pressure) applications working pressure rating of 125 PSI

### ELBOWS - STREET - 90° - GALVANIZED



PART NO.	DESCRIPTION
8.705-407.0	1/4" MPT x FPT
8.705-408.0	3/8" MPT x FPT
8.705-409.0	1/2" MPT x FPT
8.705-410.0	3/4" MPT x FPT

### TEES - BANDED - 3 CONNECTS - GALVANIZED



PART NO.	DESCRIPTION
8.705-456.0	1/4" FPT x FPT x FPT
8.705-458.0	3/8" FPT x FPT x FPT
8.705-459.0	1/2" FPT x FPT x FPT
8.705-461.0	3/4" FPT x FPT x FPT

### COUPLINGS - GALVANIZED



PART NO.	DESCRIPTION
8.705-436.0	1/4" FPT x FPT
8.705-437.0	3/8" FPT x FPT
8.705-438.0	1/2" FPT x FPT
8.705-439.0	3/4" FPT x FPT

### ELBOWS - 90° - GALVANIZED



PART NO.	DESCRIPTION
8.705-403.0	1/4" FPT x FPT
8.705-405.0	1/2" FPT x FPT
8.705-406.0	3/4" FPT x FPT

### NIPPLES - PIPE - MPT - HIGH PSI - ZINC



PART NO.	DESCRIPTION	PSI	TYPE
9.803-043.0	2" x 1/4"	6000	Zinc
8.705-441.0	3" x 1/4"	6000	Zinc
8.705-442.0	4" x 1/4"	6000	Zinc
8.705-443.0	2" x 3/8"	6000	Zinc
8.705-985.0	3" x 3/8"	6000	Zinc
8.705-445.0	4" x 3/8"	6000	Zinc
8.705-446.0	2" x 1/2"	6000	Zinc
9.802-014.0	3" x 1/2"	6000	Zinc
8.705-996.0	5" x 1/2"	6000	Zinc
8.705-450.0	2" x 3/4"	6000	Zinc
8.705-451.0	3" x 3/4"	6000	Zinc
8.705-452.0	4" x 3/4"	6000	Zinc
8.705-453.0	6" x 3/4"	6000	Zinc

### FILTERS - CHEMICAL - "THE BIG ONE"



Larger, heavier, and with more filtering area than competitors' filters.



- Corrosion-resistant Plastic
- Stepped 1/4" & 3/8" Hose Barb
- Weighted to Hold onto Bottom of Tank

PART NO.	DESCRIPTION
8.709-938.0	with Check Valve
8.709-939.0	without Check Valve

### FILTERS - CHEMICAL - BRASS



50-mesh, stainless-steel screen. Removable mesh for easy cleaning. Heavy-duty, one-piece brass body holds the filter on the bottom of tank.



- 1/4" Hose Barb
- Stainless-Steel Check Ball

PART NO.	DESCRIPTION
9.803-672.0	with Check Valve
8.709-934.0	without Check Valve

**FILTERS - CHEMICAL - BRASS / PLASTIC**

Polypropylene and brass construction.



- 7 mm Hose Barb

PART NO.	DESCRIPTION
8.709-935.0	with Check Valve
9.802-160.0	without Check Valve

**FILTERS - CHEMICAL LINES WITH FILTER**



- 6-Foot Long, 1/4" Clear Vinyl Tubing

PART NO.	DESCRIPTION	PSI
8.903-991.0	Chemical Line, Filter with Check Valve	Brass Filter
8.903-993.0	Chemical Line, Filter with Check Valve	Plastic Filter
8.903-996.0	Chemical Line, Filter without Check Valve	Plastic Filter

**FILTERS - IN-LINE - HEAVY-DUTY**



- PSI Max: 145
- GPM Max: 8
- Temperature Max: 140°F
- 1/2" Female x Male
- 50-Mesh Screen
- Unbreakable Reinforced Nylon Cap

PART NO.	DESCRIPTION	PSI
8.709-974.0	Filter	145
8.709-975.0	Filter with Auxiliary Bypass Port	145
8.704-172.0	Replacement Filter	145

**FILTERS - IN-LINE - ALL METAL**

Diecast aluminum body & cover with a black anodized finish.



- PSI Max: 580
- GPM Max: 6.6
- Temperature Max: 195°F
- 38-Mesh Screen
- 1/2" Female x Male

PART NO.	DESCRIPTION	PSI
8.709-976.0	All Metal In-Line Filter	170

**FILTERS - IN-LINE - GREEN-CAP**

The original Green-Cap!



- PSI Max: 145
- GPM Max: 6
- 50-Mesh Stainless Screen
- Aluminum Housing with a Plastic Cap
- 1/2" FPT Inlet
- 1/2" MPT Outlet
- Two 1/2" MPT Bypass Ports

PART NO.	DESCRIPTION	MAX PSI
8.709-961.0	Green Cap Filter	145
8.701-383.0	Replacement Screen	145
8.701-382.0	Replacement Cap	145
8.702-034.0	Replacement O-Ring	145

**FILTERS - CLEAR BOWL**



- Low-Profile Style
- MPT Inlet and Outlet
- White Nylon Body
- Clear Bowl
- Stainless-Steel Screen
- L3" L x 1-3/4" W x 2-3/8" H

PART NO.	DESCRIPTION	COLOR
8.709-962.0	1/4", 40-Mesh Screen	Clear Bowl
8.709-963.0	1/4", 80-Mesh Screen	Clear Bowl
8.709-964.0	3/8", 40-Mesh Screen	Clear Bowl
8.709-965.0	3/8", 80-Mesh Screen	Clear Bowl
8.709-966.0	1/2", 40-Mesh Screen	Clear Bowl
8.709-967.0	1/2", 80-Mesh Screen	Clear Bowl
8.700-563.0	80-Mesh Replacement Screen	
8.700-564.0	40-Mesh Replacement Screen	

**FILTERS - IN-LINE - CAN-TYPE**



- 40- or 80-Mesh Filtration
- Heavy-duty molded plastic with stainless-steel screen
- Hanger tab standard on 3/8", 1/2" and 3/4"
- Choose Black or Clear Filter Cans

PART NO.	DESCRIPTION	COLOR
<b>40-MESH FILTERS</b>		
8.709-982.0	3/8" Hanger Tab	Black
8.709-986.0	1/2" Hanger Tab	Black
8.709-990.0	3/4" Hanger Tab	Black
8.709-994.0	1" Hanger Tab	Black
8.710-001.0	1-1/4" Hanger Tab	Black
8.710-003.0	1-1/2" Hanger Tab	Black
8.709-983.0	3/8" Hanger Tab	Clear
8.709-987.0	1/2" Hanger Tab	Clear
8.709-991.0	3/4" Hanger Tab	Clear
8.709-996.0	1" Hanger Tab	Clear
8.710-002.0	1-1/4" Hanger Tab	Clear
8.710-004.0	1-1/2" Hanger Tab	Clear
<b>80-MESH FILTERS</b>		
8.709-988.0	1/2" Hanger Tab	Black
8.709-992.0	3/4" Hanger Tab	Black
8.709-995.0	1" Hanger Tab	Black
8.710-005.0	1-1/4" Hanger Tab	Black
8.709-999.0	1-1/2" Hanger Tab	Black
8.709-989.0	1/2" Hanger Tab	Clear
8.709-993.0	3/4" Hanger Tab	Clear
8.709-997.0	1" Hanger Tab	Clear
8.710-006.0	1-1/4" Hanger Tab	Clear
8.710-000.0	1-1/2" Hanger Tab	Clear

PART NO.	DESCRIPTION	COLOR
<b>IN-LINE CAN-TYPE FILTER PARTS - 3/8", 1/2", 3/4"</b>		
8.700-555.0	Gasket	
8.700-557.0	Viton Gasket	
8.700-559.0	Bowl	Black
8.700-560.0	Bowl	Clear
8.700-565.0	40-Mesh Screen, Blue	
8.700-567.0	80-Mesh Screen, White	
8.932-949.0	3/8" Top with Tab	
8.700-569.0	1/2" Top with Tab	
8.700-570.0	3/4" Top with Tab	
<b>IN-LINE CAN-TYPE FILTER PARTS - 1", 1-1/4", 1-1/2"</b>		
8.700-556.0	Gasket	
8.700-558.0	Viton Gasket	
8.700-566.0	1", 40-Mesh Screen	
8.700-575.0	1-1/4", 40-Mesh Screen	
8.700-576.0	1-1/2", 40-Mesh Screen	
8.700-568.0	1", 80-Mesh Screen	
8.700-577.0	1-1/4", 80-Mesh Screen	
8.700-578.0	1-1/2", 80-Mesh Screen	
8.700-571.0	1" Filter Top	
8.700-573.0	1", 1-1/4", 1-1/2" Bowl	Black
8.700-574.0	1", 1-1/4", 1-1/2" Bowl	Clear

**FILTERS - IN-LINE - CLEARVIEW**



8.710-145.0      8.710-146.0      8.710-147.0

- Stainless-Steel Screen
- Combination 1/2", 3/4" Hose Barb
- Weighted to hold at bottom of tank or source

PART NO.	DESCRIPTION
8.710-145.0	3/8" NPT x 3/4" GH
8.710-147.0	3/8" NPT x 3/4" GH with 1/4" Bypass
8.710-144.0	1/2" NPT x 3/4" GH
8.710-146.0	1/2" NPT x 3/4" GH with 1/3" Bypass



**STRAINERS - Y TRAP**



- PSI Max: 170
- Temperature Max: 194°F
- Brass Bodies and Cap
- FPT Inlet and Outlet
- Stainless-Steel 50-Mesh Cylinder Screen

PART NO.	DESCRIPTION	MAX PSI
8.709-956.0	1/4" FPT Brass Bodies and Cap	170
8.709-957.0	3/8" FPT Brass Bodies and Cap	170
8.709-958.0	1/2" FPT Brass Bodies and Cap	170
8.709-959.0	3/4" FPT Brass Bodies and Cap	170
8.709-960.0	1" FPT Brass Bodies and Cap	170

**FOOT / CHECK VALVE**

Includes backflow check and perforated screen, prevents damage to pump or control valves.



- Removable Stainless-Steel Screen
- Spring-Loaded Check Valve
- Cast-Brass Bodies
- FPT Outlet

PART NO.	DESCRIPTION	TYPE
8.709-388.0	1/2" Foot Check Valve and Screen	
8.709-389.0	3/4" Spring Check Valve	Brass
8.709-390.0	1" Spring Check Valve	Brass

**FOOT VALVES - SUCTION - ST35 / ST35R**

Weighted to hold at bottom of tank or source.



- Stainless-Steel Screen
- Combination 1/2", 3/4" Hose Barb

PART NO.	DESCRIPTION	TYPE
8.709-970.0	Suction Foot Valve with Check Valve	Stainless-steel Screen

**STRAINERS / TANK SCREEN**

Use for tank drain or chemical line.



- Stainless-Steel Screen - 40 or 50 Mesh
- PVC Base attaches to nipple or tubing

PART NO.	DESCRIPTION	MESH
8.710-008.0	1/4" FPT	50
8.710-010.0	3/8" FPT	50
8.710-011.0	1/2" FPT	40
9.802-162.0	1/2" FPT	50
8.710-013.0	3/4" FPT	40
8.710-014.0	3/4" FPT	50
8.710-015.0	1" FPT	40
8.710-016.0	1-1/2" FPT	40

**FILTERS - IN-LINE - NOZZLE - HIGH-PRESSURE**

Protect your turbo nozzle from damage caused by debris in the water flow.



8.709-978.0



8.710-149.0



8.709-979.0



8.710-150.0

- PSI Max: 5000
- Temperature: 300°F
- 1/4" MPT Outlet
- 100 Mesh Screen

PART NO.	DESCRIPTION	TYPE
8.709-978.0	1/4" FPT Inlet x 1/4" MPT Outlet	Brass
8.709-979.0	1/4" QC Inlet x 1/4" MPT Outlet	Brass
8.710-149.0	1/4" QC Inlet x 1/4" MPT Outlet	416 SS
8.710-150.0	1/4" MPT Inlet x 1/4" MPT Outlet	Brass
8.704-234.0	Replacement filter for 8.709-978.0 / 8.709-979.0	
8.701-201.0	Replacement filter for 8.710-149.0 / 8.710-150.0	

**FILTERS - FUEL**

In-line, disposable.



8.709-942.0



9.802-211.0

PART NO.	DESCRIPTION	TYPE
9.802-211.0	1/4" Inlet / Outlet	Plastic
8.709-942.0	1/4" Inlet / Outlet	Metal
8.709-943.0	3/8" Inlet / Outlet	Plastic

### FILTERS - HIGH-VOLUME

Molded plastic housing.



- PSI Max: 125
- GPM Max: 12 at 50 Micron
- GPM Max: 10 at 5 or 20 Micron
- 3/4" FPT Inlet and Outlet
- 14-1/2" Tall x 5-1/2" Port to Port

PART NO.	DESCRIPTION	MAX PSI
8.710-017.0	Housing only	125
8.753-552.0	Mounting Bracket / Hardware	125
8.700-581.0	Replacement O-ring	125



- Pleated Poyester / Polypropylene Core
- Recommended for large flow, low- pressure applications (up to 60 PSI)

PART NO.	DESCRIPTION	GPM
<b>ULTRA FINE FILTER ELEMENTS</b>		
8.710-019.0	5 Micron	10
8.710-020.0	20 Micron	10
8.710-021.0	50 Micron	12



- Recommended for maximum filtration with reduced flow requirements (up to 130 PSI)

PART NO.	DESCRIPTION	GPM
<b>SYNTHETIC STRING WOUND ELEMENTS</b>		
8.710-022.0	5 Micron	4
8.710-023.0	20 Micron	5
8.710-024.0	50 Micron	6

### FILTERS - FUEL - CLEAR BOWL



- Aluminum Housing
- Non-replaceable 120 mesh stainless-steel screen
- 1/4" x 1/4"
- Clear Acrylic Bowl

PART NO.	DESCRIPTION
8.709-948.0	Complete Unit

### FILTERS - FUEL / WATER SEPARATOR - LEGACY



- 10 Micron Filtration
- Spin-On Convenience
- Water-Separation Chamber
- 1/4" FPT Inlet / Outlet
- Easy Drain Water / Sediment Bowl

PART NO.	DESCRIPTION
8.725-306.0	Complete Unit
8.725-307.0*	Element Only

\*Order 24 for a full case

### FILTERS - BLUE TOP



PART NO.	DESCRIPTION	TYPE
<b>HOUSING</b>		
8.753-559.0	Housing, 5", 1/2" F-F	
8.753-561.0	Housing, 5", 1" F-F	
8.753-562.0	Housing, 10", 1/2" F-F	
<b>CARTRIDGE</b>		
8.753-564.0	Cartridge, 10" Poly Thread	Disposable
8.753-566.0	Cartridge, 10" Nylon Mesh	Washable

### FILTERS - FUEL ELEMENT - GENERAL



- Can Type
- GPM Max: 10
- 10 Micron Filtration
- Inexpensive Replacement
- Wool Felt Element

PART NO.	DESCRIPTION
8.709-950.0	Element Only - 1A-30

**FILTERS - FUEL / WATER SEPARATOR - RACOR**



The "Max" fuel system protector.



- 10 Micron Filtration
- Spin-On Convenience
- Water-Separation Chamber
- 1/4" FPT Inlet / Outlet
- Easy Drain Water / Sediment Bowl

PART NO	DESCRIPTION
9.802-212.0	Complete Unit
8.709-953.0	Element
8.700-553.0	Plastic Bowl

**FILTERS - FUNNEL - RACOR**



- GPM: 3.9
- Telfon-Coated, Stainless-Steel Filter
- Separates Free Water and Contaminates from Gasoline / Diesel / Kerosene

PART NO.	DESCRIPTION
8.709-955.0	Racor Filter Funnel



**SEWER / TUBE CLEANING NOZZLES - ST-49 & "MINI"**

The reverse jets on the fixed and rotary nozzles pull the hose through the tube or sewer line and blast debris from line or tube walls.



0 -forward, 3 back ports



1 -forward, 4 back ports



1 -forward, 3 back ports



0 -forward, 3 back ports



0 -forward, 2 side ports

- PSI: 4200
- Physically Small for Cornering Ability
- Corrosion-resistant Stainless-steel Construction
- Backward Ports Drive the Nozzle Forward and Flush Debris
- Orifice Size Indicated on Non-rotating Styles
- Forward Ports Blast into Pipe and Breaks Up Clogs and Debris
- Rotating Style Adds Extra Agitation and Surface Cleaning

PART NO.	NOZZLE	ORIFICE SIZE	O.D.	PORTS
<b>NON-ROTATING "MINI" SEWER NOZZLES</b>				
8.710-875.0	1/8"	4.5	.580"	0-Forward, 3 Back
8.710-874.0	1/8"	5.5	.580"	1-Forward, 3 Back
8.710-878.0	1/4"	4.5	.730"	1-Forward, 3 Back
8.710-876.0	1/4"	5.5	.730"	1-Forward, 3 Back
8.710-877.0	1/4"	6.0	.730"	1-Forward, 4 Back
8.710-880.0	1/4"	7.5	.730"	1-Forward, 4 Back
8.710-879.0	1/4"	8.0	.730"	1-Forward, 3 Back
8.710-881.0	1/4"	12	.730"	1-Forward, 3 Back
8.710-885.0	3/8"	4.0	.920"	1-Forward, 3 Back
8.710-884.0	3/8"	5.5	.920"	1-Forward, 3 Back
8.710-886.0	3/8"	8.5	.920"	1-Forward, 4 Back
8.710-883.0	3/8"	12	.920"	1-Forward, 4 Back
8.710-882.0	3/8"	14	.920"	1-Forward, 4 Back

- PSI: 4000
- Rotating Sewer Nozzle
- Adds Extra Agitation
- Back Jet Only

PART NO.	ROTATING NOZZLE	ORIFICE SIZE	PORTS
<b>ST-49 ROTATING SEWER NOZZLES</b>			
8.710-899.0	1/8"	5.5	0-Forward, 3 Back
8.710-898.0	1/4"	5.5	0-Forward, 3 Back
8.710-900.0	1/4"	8.0	0-Forward, 3 Back
8.710-887.0	1/4" Duct Cleaner*	5.5	0-Forward, 2 Side

\*Duct Cleaner jet to sides instead of reverse

**SEWER / TUBE CLEANING NOZZLES**

- PSI: 5000
- Corrosion-resistant Stainless-steel
- One Forward Orifice
- Three Rear Orifices



PART NO.	FPT	SIZE
8.710-905.0	1/8"	5.0
8.710-906.0	1/8"	5.5
8.710-907.0	1/8"	6.0
8.710-908.0	1/4"	6.5
8.710-909.0	1/4"	7.0
8.710-910.0	1/4"	9.5

**NOZZLE SIZE SELECTION CHART**

Determine the nozzle size by the pressure washer's GPM @ PSI (gallons per minute @ a specific pounds per square inch). If the nozzle size is too small, your equipment can be damaged. If the nozzle size is too large, cleaning ability is compromised. Nozzle fan degree does not effect nozzle size selection.

STANDARD NOZZLE SIZE	HOLE SIZE	POUNDS PER SQUARE INCH (PSI)																
		500	750	1000	1250	1500	1750	2000	2250	2500	2750	3000	3250	3500	3750	4000	4500	5000
2	.034"/0.86mm	0.71	0.87	1.00	1.12	1.22	1.32	1.41	1.50	1.58	1.66	1.73	1.80	1.87	1.94	2.00	2.12	2.24
2.5	.042"/1.07mm	0.88	1.08	1.25	1.40	1.53	1.65	1.77	1.88	1.98	2.07	2.17	2.25	2.34	2.42	2.50	2.65	2.80
3	.043"/1.09mm	1.06	1.30	1.50	1.68	1.84	1.98	2.12	2.25	2.37	2.49	2.60	2.70	2.81	2.90	3.00	3.18	3.35
3.5	.048"/1.22mm	1.24	1.52	1.75	1.96	2.14	2.32	2.47	2.63	2.77	2.90	3.03	3.15	3.27	3.39	3.50	3.71	3.91
4	.052"/1.32mm	1.41	1.73	2.00	2.24	2.45	2.65	2.83	3.00	3.16	3.32	3.46	3.61	3.74	3.87	4.00	4.24	4.47
4.5	.055"/1.40mm	1.59	1.95	2.25	2.52	2.76	2.98	3.18	3.38	3.56	3.73	3.90	4.06	4.21	4.36	4.50	4.77	5.03
5	.057"/1.45mm	1.77	2.17	2.50	2.80	3.06	3.31	3.54	3.75	3.95	4.15	4.33	4.51	4.68	4.84	5.00	5.30	5.59
5.5	.06"/1.52mm	1.94	2.38	2.75	3.07	3.37	3.64	3.89	4.13	4.35	4.56	4.76	4.96	5.14	5.33	5.50	5.83	6.15
6	.062"/1.57mm	2.12	2.60	3.00	3.35	3.67	3.97	4.24	4.50	4.74	4.97	5.20	5.41	5.61	5.81	6.00	6.36	6.71
6.5	.064"/1.63mm	2.30	2.81	3.25	3.63	3.98	4.30	4.60	4.88	5.14	5.39	5.63	5.86	6.08	6.29	6.50	6.89	7.27
7	.067"/1.70mm	2.47	3.03	3.50	3.91	4.29	4.63	4.95	5.25	5.53	5.80	6.06	6.31	6.55	6.78	7.00	7.42	7.83
7.5	.070"/1.78mm	2.65	3.25	3.75	4.19	4.59	4.96	5.30	5.63	5.93	6.22	6.50	6.76	7.02	7.26	7.50	7.95	8.39
8	.072"/1.83mm	2.83	3.46	4.00	4.47	4.90	5.29	5.66	6.00	6.32	6.63	6.93	7.21	7.48	7.75	8.00	8.49	8.94
8.5	.074"/1.88mm	3.01	3.68	4.25	4.75	5.21	5.62	6.01	6.38	6.72	7.05	7.36	7.66	7.95	8.23	8.50	9.02	9.50
9	.076"/1.93mm	3.18	3.90	4.50	5.03	5.51	5.95	6.36	6.75	7.12	7.46	7.79	8.11	8.42	8.71	9.00	9.55	10.06
9.5	.078"/1.98mm	3.36	4.11	4.75	5.31	5.82	6.28	6.72	7.13	7.51	7.88	8.23	8.56	8.89	9.20	9.50	10.08	10.62
10	.080"/2.03mm	3.54	4.33	5.00	5.59	6.12	6.61	7.07	7.50	7.91	8.29	8.66	9.01	9.35	9.68	10.00	10.61	11.18
11	.083"/2.11mm	3.89	4.76	5.50	6.15	6.74	7.28	7.78	8.25	8.70	9.12	9.53	9.92	10.29	10.65	11.00	11.67	12.30
12	.087"/2.21mm	4.24	5.20	6.00	6.71	7.35	7.94	8.49	9.00	9.49	9.95	10.39	10.82	11.22	11.62	12.00	12.73	13.42
12.5	.089"/2.26mm	4.42	5.41	6.25	6.99	7.65	8.27	8.84	9.38	9.88	10.36	10.83	11.27	11.69	12.10	12.50	13.26	13.98
13	.091"/2.31mm	4.60	5.63	6.50	7.27	7.96	8.60	9.19	9.75	10.28	10.78	11.26	11.72	12.16	12.59	13.00	13.79	14.53
15	.096"/2.44mm	5.30	6.50	7.50	8.39	9.19	9.92	10.61	11.25	11.86	12.44	12.99	13.52	14.03	14.52	15.00	15.91	16.77
20	.109"/2.77mm	7.07	8.66	10.00	11.18	12.25	13.23	14.14	15.00	15.81	16.58	17.32	18.03	18.71	19.36	20.00	21.21	22.36
25	.125"/3.18mm	8.84	10.83	12.50	13.98	15.31	16.54	17.68	18.75	19.76	20.73	21.65	22.53	23.39	24.21	25.00	26.52	27.95
30	.141"/3.58mm	10.61	12.99	15.00	16.77	18.37	19.84	21.21	22.50	23.72	24.87	25.98	27.04	28.06	29.05	30.00	31.82	33.54
40	.156"/3.96mm	14.14	17.32	20.00	22.36	24.49	26.48	28.28	30.00	31.62	33.17	34.64	36.06	37.42	38.73	40.00	42.43	44.72
50	.172"/4.37mm	17.68	21.65	25.00	27.95	30.62	33.07	35.36	37.50	39.53	41.46	43.30	45.07	46.77	48.41	50.00	53.03	55.90
60	.188"/4.78mm	21.21	25.98	30.00	33.54	36.74	39.69	42.43	45.00	47.43	49.75	51.96	54.08	56.12	58.09	60.00	63.64	67.08

GALLONS PER MINUTE - GPM

**NOZZLE FAN SELECTION**

Select the nozzle degree or spray angle, based on your application. Standard nozzle degrees - 0°, 15°, 25° and 40°. Using the wrong nozzle degree can damage the surface you are cleaning.

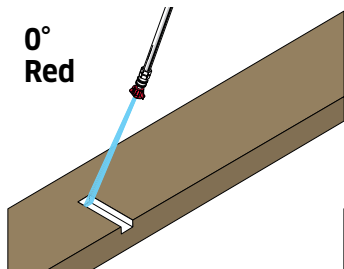
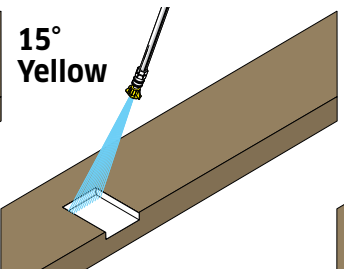
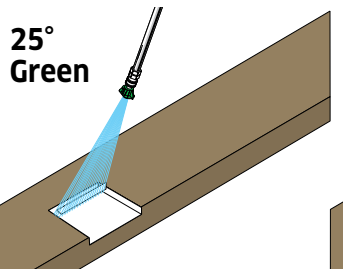
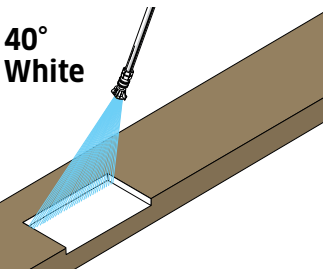
<p><b>0° Red</b></p>  <p><b>CUTTING NOZZLE</b> Delivers a concentrated stream that can gouge or cut. It can cut stubborn stains from concrete and other hard surfaces.</p>	<p><b>15° Yellow</b></p>  <p><b>CHISELING NOZZLE</b> Working at a 45° angle, this nozzle works like a scraper, stripping paint, grease and grime from hard surfaces.</p>	<p><b>25° Green</b></p>  <p><b>FLUSHING NOZZLE</b> Most commonly used nozzle for cleaning dirt from siding, sidewalks and metal furniture as well as wet sweeping leaves.</p>	<p><b>40° White</b></p>  <p><b>WASH NOZZLE</b> Wide spray to wash and rinse large areas quickly. Usually safe for most surfaces, including aluminum siding, windows and vehicles.</p>
--	---	---	--



### NOZZLE SETS - LEGACY - QC 4 & 5 PACKS - COLOR-CODED

1/4" Quick Coupler Nozzle Kits

- Hardened stainless-steel, one-piece body for long life
- High-impact, uniform, flat-spray pattern
- Color-coded by spray angle
- Includes 40 x 65 soap nozzle

**Legacy**

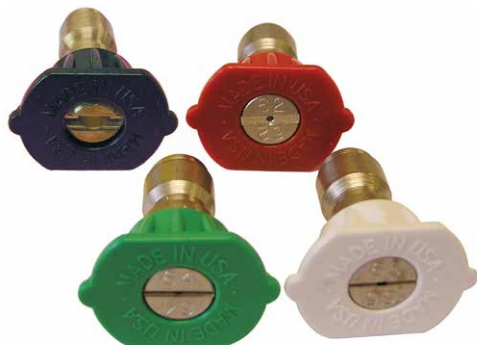

4/PK (0°, 25°, 40° and Soap)



5/PK (0°, 15°, 25°, 40° and Soap)

PART NO.	NOZZLE SIZE	DESCRIPTION
<b>4/PK (0°, 25°, 40° AND SOAP)</b>		
8.726-117.0	3.0	4 pack Nozzle Kit
9.104-028.0	3.25	4 pack Nozzle Kit
8.726-119.0	3.5	4 pack Nozzle Kit
8.726-120.0	4.0	4 pack Nozzle Kit
8.726-121.0	4.5	4 pack Nozzle Kit
8.726-122.0	5.0	4 pack Nozzle Kit
8.726-123.0	5.5	4 pack Nozzle Kit
8.726-124.0	6.0	4 pack Nozzle Kit
8.726-125.0	6.5	4 pack Nozzle Kit
<b>5/PK (0°, 15°, 25°, 40° AND SOAP)</b>		
9.104-024.0	3.0	5 pack Nozzle Kit
9.104-016.0	3.25	5 pack Nozzle Kit
8.726-128.0	3.5	5 pack Nozzle Kit
9.104-030.0	4.0	5 pack Nozzle Kit
8.726-130.0	4.5	5 pack Nozzle Kit
8.726-131.0	5.0	5 pack Nozzle Kit
8.726-132.0	5.5	5 pack Nozzle Kit
8.726-133.0	6.0	5 pack Nozzle Kit
8.726-134.0	6.5	5 pack Nozzle Kit

### NOZZLES - LEGACY - QC - 1/4" COLOR-CODED

Quick connect, Color-coded, hardened stainless nozzle. Fits msot 1/4" quick couplers. Rated for 4000 PSI.

**Legacy**



ORIFICE	PART NO. 0°	PART NO. 15°	PART NO. 25°	PART NO. 40°
<b>QC NOZZLES</b>				
	RED	YELLOW	GREEN	WHITE
3.0	<b>S</b> 8.723-576.0	8.902-482.0	8.902-484.0	8.902-485.0
3.25	8.708-538.0	8.708-539.0	8.708-540.0	8.708-541.0
3.5	<b>S</b> 8.723-577.0	8.726-104.0	8.708-526.0	8.902-487.0
3.75	8.708-527.0	8.708-528.0	8.708-529.0	8.708-530.0
4.0	8.708-531.0	8.708-532.0	8.708-533.0	8.708-534.0
4.5	8.723-578.0	8.708-535.0	8.708-536.0	8.708-537.0
5.0	<b>S</b> 8.726-105.0	8.726-106.0	8.726-107.0	8.726-108.0
5.5	<b>S</b> 8.723-579.0	8.902-492.0	8.708-542.0	8.902-493.0
6.0	8.726-109.0	8.726-110.0	8.726-111.0	8.726-112.0
6.5	8.726-113.0	8.726-114.0	8.726-115.0	8.726-116.0
<b>QC SOAP NOZZLES</b>				
PART NO.	ORIFICE	DEGREE		
8.723-636.0	40	65°		

## NOZZLES

### NOZZLE SETS - GP - QC 4 & 5 PACKS - COLOR-CODED

Nozzle sets of quick coupler nozzles



- 4-pack Set : 0°, 15°, 25° and 40°
- 5-pack also includes one 40 x 65° soap nozzle.

PART NO.	NOZZLE SIZE
<b>4/PK (0°, 15°, 25° AND 40°)</b>	
8.708-712.0	3.5
8.708-713.0	4.0
8.708-714.0	4.5
8.708-715.0	5.0
8.708-716.0	5.5
8.708-717.0	6.0
8.708-718.0	6.5

PART NO.	NOZZLE SIZE
<b>5/PK (0°, 15°, 25°, 40° AND SOAP)</b>	
9.104-014.0	3.5
8.708-721.0	4.0
9.104-015.0	4.5
8.708-723.0	5.0
8.708-724.0	5.5
8.708-725.0	6.0
8.708-726.0	6.5

### NOZZLES - QC - 1/4" - Q-STYLE



- Rated for 5000 PSI
- Quick-coupled
- Color-coded
- Hardened stainless nozzles fit most 1/4" quick couplers

	RED	YELLOW	GREEN	WHITE
ORIFICE	PART NO. 0°	PART NO. 15°	PART NO. 25°	PART NO. 40°
2.0	8.708-644.0	8.712-322.0	8.708-645.0	8.708-652.0
2.5	8.708-647.0	8.708-648.0	8.708-649.0	8.708-651.0
3.0	9.802-287.0	8.712-333.0	8.712-334.0	8.712-335.0
3.5	9.802-291.0	8.712-338.0	8.712-339.0	8.712-340.0
4.0	9.802-295.0	8.712-346.0	8.712-347.0	8.712-348.0
4.5	9.803-810.0	8.712-350.0	8.712-351.0	8.712-352.0
5.0	9.802-299.0	8.712-354.0	8.712-355.0	8.712-356.0
5.5	9.802-303.0	8.712-358.0	8.712-359.0	8.712-360.0
6.0	9.802-307.0	8.712-362.0	8.712-363.0	8.712-364.0
6.5	8.708-681.0	8.708-682.0	8.708-683.0	8.708-684.0
7.0	9.803-800.0	9.803-801.0	9.803-802.0	9.803-803.0
7.5	8.708-689.0	8.708-690.0	8.708-691.0	8.708-692.0
8.0	8.708-693.0	8.708-694.0	8.708-695.0	8.708-696.0
8.5	8.708-697.0	8.708-698.0	8.708-699.0	8.708-700.0
9.0	8.708-701.0	8.712-379.0	8.708-703.0	8.712-381.0
10.0	8.708-705.0	8.708-706.0	8.708-707.0	8.708-708.0

### NOZZLES - MEG - 1/4" - M-STYLE

Hardened stainless-steel nozzle insert ensures consistent, accurate orifice size



- 1/4" male pipe thread nozzles
- Rated up to 5000 PSI
- 303 Series Stainless-steel

ORIFICE	PART NO. 0°	PART NO. 15°	PART NO. 25°	PART NO. 40°
2.5	-	8.708-569.0	8.708-650.0	8.708-570.0
3.0	8.708-572.0	8.711-370.0	8.708-574.0	8.708-575.0
3.5	8.708-576.0	8.708-577.0	8.708-578.0	8.708-579.0
4.0	8.708-580.0	8.708-581.0	8.708-582.0	8.708-583.0
4.5	8.708-584.0	8.708-585.0	8.708-586.0	8.708-587.0
5.0	8.708-588.0	8.708-589.0	8.708-590.0	8.708-591.0
5.5	8.708-592.0	8.708-593.0	8.708-594.0	8.708-595.0
6.0	8.708-596.0	8.708-597.0	8.708-598.0	8.708-599.0
6.5	8.708-600.0	8.708-601.0	8.708-602.0	8.708-603.0
7.0	8.708-604.0	8.708-605.0	8.708-606.0	8.708-607.0
7.5	8.708-608.0	8.708-609.0	8.708-610.0	8.708-611.0
8.0	8.708-612.0	8.708-613.0	8.708-614.0	8.708-615.0
8.5	8.708-616.0	8.708-617.0	8.708-618.0	8.708-619.0
9.0	8.708-620.0	8.708-621.0	8.708-622.0	8.708-623.0
10.0	8.708-624.0	8.708-625.0	8.708-626.0	8.708-627.0

### NOZZLES - SOAP NOZZLES

Ideal for low-pressure chemical applications



- Brass
- Large #40 Orifice
- 15° or 65° Spray Angle.

PART NO.	ORIFICE	DEGREE
<b>1/4" QC</b>		
9.802-311.0	40	65°
8.708-711.0	50	15°
<b>1/8" MEG</b>		
8.708-410.0	40	65°
<b>1/4" MEG</b>		
8.708-268.0	40	65°
8.708-277.0	50	15°

### NOZZLE HOLDER GROMMET



PART NO.	DESCRIPTION
8.710-343.0	1/16" x 15/16" x 3/8"

### 2ND STORY NOZZLE KIT, 2 PK.



- Easily Clean 2nd Story Exteriors
- QC Detergent and Rinse Applicators .

PART NO.	DESCRIPTION
9.114-995.0	Nozzle Kit, 2 pk.

**NOZZLES - MEG - 1/4" MALE THREADS**

1/4" male pipe thread meg nozzles, rated up to 4000 PSI. Hardened stainless-steel nozzle ensures consistent, accurate orifice size.

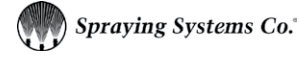

- PSI: 4000
- Orifice Recessed for Protection
- Flow-Rated Tolerance of + 2% at 70°F
- Hard-edge pattern, light center requires overlap to cover center
- 400 Series Stainless-steel

ORIFICE	PART NO. 0°	PART NO. 15°	PART NO. 25°	PART NO. 40°
2.0	8.707-637.0	8.707-640.0	8.707-643.0	8.707-648.0
2.5	8.707-646.0	8.707-650.0	8.707-653.0	8.707-652.0
3.0	8.707-655.0	8.707-657.0	8.707-659.0	8.707-661.0
3.5	8.707-662.0	8.707-664.0	8.707-666.0	8.707-667.0
4.0	8.707-669.0	8.707-671.0	8.707-673.0	8.707-675.0
4.5	8.707-678.0	8.707-679.0	8.707-680.0	8.707-681.0
5.0	8.707-683.0	8.707-686.0	8.707-688.0	8.707-691.0
5.5	8.707-694.0	8.707-695.0	8.707-697.0	8.707-698.0
6.0	8.707-700.0	8.707-702.0	8.707-703.0	8.707-705.0
6.5	8.707-708.0	8.707-710.0	8.707-711.0	8.707-712.0
7.0	8.707-713.0	8.707-715.0	8.707-716.0	8.707-717.0
7.5	8.707-718.0	8.707-719.0	8.707-721.0	8.707-722.0
8.0	8.707-723.0	8.707-726.0	8.707-727.0	8.707-729.0
8.5	8.707-734.0	8.707-735.0	8.707-736.0	8.707-738.0
9.0	8.707-739.0	8.707-741.0	8.707-743.0	8.707-746.0
10.0	8.707-747.0	8.707-751.0	8.707-754.0	8.707-756.0
11.0	8.707-760.0	8.707-761.0	8.707-762.0	8.707-763.0
12.0	8.707-764.0	8.707-766.0	8.707-767.0	8.707-768.0
12.5	8.707-769.0	8.707-770.0	8.707-771.0	8.707-772.0
13.0	8.707-773.0	8.707-774.0	8.707-776.0	8.707-778.0
15.0	8.707-782.0	8.707-787.0	8.707-789.0	8.707-790.0
20.0	8.707-795.0	8.707-800.0	8.707-802.0	8.707-804.0
25.0	8.707-807.0	8.707-811.0	8.707-812.0	8.707-813.0
30.0	8.707-814.0	8.707-817.0	8.707-818.0	8.707-819.0
40.0	8.707-821.0	8.707-824.0	8.707-826.0	8.707-827.0
50.0	8.707-828.0	8.707-830.0	8.707-832.0	8.707-833.0
60.0	8.707-834.0	8.707-835.0	8.707-837.0	8.707-838.0

PART NO.	NOZZLE SIZE
<b>8.700-561.0</b>	1/4" Small 2.0 - 20.0 Meg

**NOZZLES - MEG - 1/8" - "WASHJET"**

1/8" male pipe thread meg nozzles, rated up to 4000 PSI. Hardened stainless-steel nozzle ensures consistent, accurate orifice size.

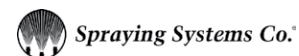

- PSI: 4000
- Orifice Recessed for Protection
- Flow-Rated Tolerance of + 2% at 70°F
- Hard-edge pattern, light center requires overlap to cover center
- 400 Series Stainless-steel

ORIFICE	PART NO. 0°	PART NO. 15°	PART NO. 25°	PART NO. 40°
2.0	8.707-529.0	8.707-536.0	8.707-537.0	8.707-538.0
2.5	-	8.707-539.0	8.711-465.0	-
3.0	8.707-540.0	8.707-542.0	8.707-543.0	8.707-544.0
3.5	-	8.707-545.0	8.707-546.0	-
4.0	8.707-547.0	8.707-549.0	8.707-550.0	8.707-551.0
4.5	8.707-552.0	8.707-554.0	8.707-556.0	8.707-557.0
5.0	8.707-558.0	8.707-559.0	8.707-561.0	8.707-564.0
5.5	8.707-567.0	8.707-568.0	8.707-569.0	8.707-570.0
6.0	8.707-571.0	8.707-572.0	8.707-573.0	8.707-575.0
6.5	8.707-577.0	8.707-578.0	8.707-579.0	8.707-581.0
7.0	8.707-582.0	8.707-584.0	8.707-585.0	8.707-586.0
7.5	8.707-588.0	8.707-589.0	8.707-591.0	8.707-592.0*
8.0	8.707-593.0	8.707-594.0	8.707-595.0	8.707-596.0
8.5	8.707-598.0	8.707-599.0	8.707-600.0	8.707-601.0
9.0	8.707-602.0	8.707-604.0	8.707-605.0	8.707-607.0
9.5	-	8.707-609.0	8.707-610.0	8.707-611.0
10.0	8.707-612.0	8.707-613.0	8.707-614.0	8.707-616.0
11.0	8.707-618.0	8.707-619.0	8.707-620.0	-
12.0	8.707-621.0	-	-	8.707-623.0
15.0	8.707-625.0	8.707-626.0	8.707-627.0	-

**NOZZLES - QC "WASH JET"**

"QC" or Quick Connect Hardened Stainless Meg Nozzle, fits most 1/4" quick couplers. Rated for 4000 PSI..

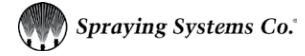

- PSI: 4000
- Temperature: 300°F
- Flow-Rated Tolerance of + 2%
- Hardened Stainless-Steel
- Fits Hansen and Parker Quick-Couplers

ORIFICE	PART NO. 0° RED	PART NO. 15° YELLOW	PART NO. 25° GREEN	PART NO. 40° WHITE
2.0	-	8.708-415.0	8.708-416.0	-
3.0	8.708-417.0	8.708-418.0	8.708-419.0	8.708-420.0
3.5	8.708-422.0	8.708-423.0	8.708-424.0	8.708-425.0
4.0	8.708-427.0	8.708-428.0	8.708-429.0	8.708-430.0
4.5	8.708-431.0	8.708-432.0	8.708-433.0	8.708-434.0
5.0	8.708-435.0	8.708-436.0	8.708-437.0	8.708-438.0
5.5	8.708-439.0	8.708-440.0	8.708-441.0	8.708-442.0
6.0	8.708-443.0	8.708-444.0	8.708-445.0	8.708-446.0
6.5	8.708-447.0	8.708-448.0	8.708-449.0	8.708-450.0
7.0	8.708-451.0	8.708-452.0	8.708-453.0	8.708-454.0
7.5	8.708-455.0	8.708-456.0	8.708-457.0	8.708-458.0
8.0	8.708-459.0	8.708-460.0	8.708-461.0	8.708-462.0
9.0	-	8.708-463.0	8.708-464.0	8.708-465.0
10.0	8.708-467.0	8.708-468.0	8.708-469.0	8.708-470.0
12.0	8.708-471.0	8.708-472.0	-	8.708-474.0

**NOZZLES - 1/4" VEEJET - BROAD SPRAY STAINLESS-STEEL**

1/4" male pipe thread 303 stainless-steel Vee Jet nozzles, low - to medium-volume up to 500 PSI medium-pressure / special application PSI.

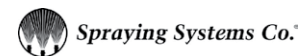

- PSI: 5 Min - 500 Max
- Vee Jet Nozzle
- 303 Stainless-Steel
- GPH: 10.61 to 106 GPH (11.15 to 112 ml/sec)

NOZZLE	ORIFICE DIAMTER	PART NO. 50°	PART NO. 65°	PART NO. 80°	PART NO. 95°	PART NO. 100°
1.0	.026	8.708-074.0	8.708-075.0	8.708-076.0	8.708-078.0	8.708-079.0
1.5	.031	8.708-085.0	8.708-086.0	8.708-087.0	8.708-089.0	8.708-090.0
2.0	.036	8.708-095.0	8.708-096.0	8.708-097.0	8.708-099.0	8.708-101.0
3.0	.043	8.708-108.0	8.708-109.0	8.708-110.0	8.708-112.0	8.708-114.0
4.0	.047	8.708-121.0	8.708-122.0	8.708-123.0	8.708-125.0	8.708-127.0
5.0	.053	8.708-133.0	8.708-134.0	8.708-136.0	8.708-138.0	8.708-140.0
6.0	.058	8.708-148.0	8.708-149.0	8.708-151.0	8.708-155.0	8.708-157.0
7.0	.063	8.708-162.0	8.708-163.0	8.708-164.0	-	8.708-165.0
8.0	.067	8.708-172.0	8.708-173.0	8.708-175.0	8.708-177.0	8.708-179.0

## NOZZLES - 1/4" VEEJET - LOW-PRESSURE - BRASS

1/4" male pipe thread Vee Jet nozzles, brass inexpensive alternative for applications up to 500 PSI.

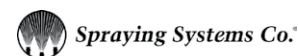

- PSI: Up to 500 PSI
- Feather Edge for Wide Coverage
- Allows Overlap for Even Application
- 1/4" MPT Connects
- Excellent for low-pressure chemical and acid applications
- Uniform spray distribution with flow rates from .012 to 1237 GPM

NOZZLE SIZE	PART NO. 0°	PART NO. 15°	PART NO. 25°	PART NO. 40°	PART NO. 50°	PART NO. 65°
15	8.708-203.0	8.708-204.0	8.708-206.0	8.708-208.0	8.708-210.0	8.708-212.0
20	8.708-218.0	8.708-222.0	8.708-225.0	8.708-228.0	8.708-230.0	8.708-232.0
30	8.708-242.0	8.708-244.0	8.708-246.0	8.708-249.0	8.708-251.0	8.708-253.0
40	8.708-258.0	8.708-260.0	8.708-262.0	8.708-264.0	8.708-266.0	8.708-268.0
50	8.708-275.0	8.708-277.0	8.708-279.0	8.708-280.0	8.708-282.0	8.708-284.0
60	8.708-289.0	8.708-290.0	8.708-292.0	8.708-294.0	8.708-296.0	8.708-297.0
70	8.708-302.0	8.708-304.0	8.708-306.0	8.708-308.0	8.708-309.0	8.708-310.0

## NOZZLE SYSTEM - TIP JET

"Tip-Jet" Nozzle Systems are versatile nozzling systems for everyday or specialized applications. Flat spray, full cone, hollow cone and solid stream patterns, metering orifices and atomizing tips are all available in the Tip-Jet system. Capacities range from .55 to 20 GPM.



- PSI: 4000
- Neat and simple tip change
- Strainers Available
- Hardened stainless-steel tips with vanes for maximum spray integrity
- Body components available in brass, zinc-plated steel or stainless-steel

ORIFICE	PART NO. 0°	PART NO. 15°	PART NO. 25°	PART NO. 40°
3.0	8.708-016.0	8.708-017.0	8.708-018.0	-
4.0	8.708-019.0	8.708-020.0	8.708-021.0	8.708-022.0
4.5	8.708-023.0	8.708-024.0	8.708-025.0	8.708-026.0
5.0	8.708-027.0	8.708-028.0	8.708-029.0	8.708-030.0
5.5	8.708-031.0	8.708-032.0	8.708-033.0	8.708-034.0
6.0	8.708-035.0	8.708-036.0	8.708-037.0	8.708-038.0
6.5	8.708-039.0	-	8.708-040.0	8.708-041.0
7.0	8.708-042.0	8.708-043.0	8.708-044.0	8.708-045.0
10.0	8.708-058.0	8.708-059.0	8.708-060.0	8.708-061.0

## NOZZLE SYSTEM - TIP JET NOZZLE BODIES

Tip-Jet Nozzle Bodies, MPT inlet connections in 1/4", 3/8" and 1/2" sizes. All outlet connections are 11/16" - 16 male thread to fit Tip-Jet tip retainers and adapters.



PART NO.	DESCRIPTION	TYPE
8.707-886.0	MPT 1/4"	Nylon
8.707-898.0	MPT 1/4"	Brass
8.707-899.0	MPT 1/4"	Stainless-steel
8.707-916.0	MPT 1/4"	Polypropylene

## NOZZLES

### NOZZLES - SOAP



"Black" Soap Nozzles are brass with a large #40 orifice. Ideal for low-pressure chemical applications.

PART NO.	SIZE	NOZZLE DEGREE
8.708-478.0	40	25°
8.708-479.0	40	65°

### NOZZLE SYSTEM - TIP JET ADAPTER CAPS



Tip-Jet Adapter Caps, similar to tip retainers, but have FPT connections for in-line applications.

PART NO.	DESCRIPTION	TYPE
8.707-919.0	MPT 1/8"	Brass
8.707-921.0	MPT 1/4"	Brass

### NOZZLE SYSTEM - TIP JET RETAINER



Tip Retainer 18 mm thread, fits vent grip lance.

PART NO.	DESCRIPTION
8.710-901.0	Hex Tip Retainer

### NOZZLE SYSTEM - TIP JET RETAINER CAPS



Tip-Jet Retainer Caps, fits all Tip-Jet nozzle bodies, holds spray tips and metering orifices firmly in place.

PART NO.	DESCRIPTION	TYPE
8.707-915.0	Hex	Brass
8.707-918.0	Hex	Plated Steel
8.707-888.0	Hex	Stainless-steel

### NOZZLE SYSTEM - TIP JET STRAINERS



Tip-Jet Strainers fit into nozzle body cavity to stop nozzle clogging.

PART NO.	DESCRIPTION
8.725-693.0	100-Mesh

### NOZZLES - LEGACY REVOLUTION TURBO

**Legacy**

Legacy is proud to offer the Revolution rotary nozzle. This turbo rotary nozzle is rated for up to 4350 PSI at 185°F. Turning at an astounding 4,000 RPM, the Revolution delivers faster and deeper cleaning action for the same price of 3000 PSI rotary nozzles.

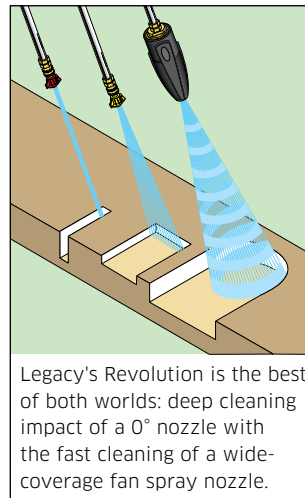

Legacy's Revolution is the best of both worlds: deep cleaning impact of a 0° nozzle with the fast cleaning of a wide-coverage fan spray nozzle.

- Greater Cleaning Power**  
 Engineered to increase impact pressure by more than 10 times that of conventional nozzles
- Longer Operating Life**  
 The Revolution's operating life is extended significantly by its wear-resistant ceramic nozzle and bearing ring
- More Durable and Versatile**  
 The Revolution features an extra-resilient housing protector and is capable of handling a stream up to 4350 PSI at 185°F

PART NO.	ORIFICE	PSI
<b>NOZZLE</b>		
9.302-242.0	3.5	4350
9.302-243.0	4.0	4350
9.302-244.0	4.5	4350
9.302-245.0	5.0	4350
9.302-246.0	5.5	4350
9.302-247.0	6.5	4350
9.302-248.0	7.0/8.0	4350
9.302-249.0	12.0	4350
<b>REPAIR KIT</b>		
2.884-972.0	3.5	
2.883-824.0	4.0	
9.302-231.0	4.5	
2.883-823.0	5.0	
2.883-822.0	5.5	
9.302-234.0	6.5	
2.883-474.0	7.0-8.0	
2.884-975.0	10.0	
2.884-051.0	12.0	



## NOZZLES - A+ / AP REVOLUTION TURBO

AP Revolution Turbo Nozzle is rated for up to 5000 PSI at 212°F. High-impact nozzle at unbelievable pricing!



- Forged Brass
- Precision Ceramic
- Durable Rubber Cover



3000 PSI

4000 PSI

5000 PSI

PART NO.	ORIFICE	PSI
<b>NOZZLE</b>		
8.726-056.0	3.5	3000
8.726-057.0	4.0	3000
8.726-058.0	4.5	3000
8.726-059.0	5.0	3000
8.726-060.0	5.5	3000
8.726-061.0	6.0	3000
8.726-068.0	3.5	4000
8.726-069.0	4.0	4000
8.726-070.0	4.5	4000
8.726-071.0	5.0	4000
8.726-072.0	5.5	4000
8.726-073.0	6.0	4000
8.726-080.0	3.5	5000
8.726-081.0	4.0	5000
8.726-082.0	4.5	5000
8.726-083.0	5.0	5000
8.726-084.0	5.5	5000
8.726-085.0	6.0	5000

PART NO.	ORIFICE	PSI
<b>REPAIR KIT</b>		
8.726-062.0	3.5	3000
8.726-063.0	4.0	3000
8.726-064.0	4.5	3000
8.726-065.0	5.0	3000
8.726-066.0	5.5	3000
8.726-067.0	6.0	3000
8.726-074.0	3.5	4000
8.726-075.0	4.0	4000
8.726-076.0	4.5	4000
8.726-077.0	5.0	4000
8.726-078.0	5.5	4000
8.726-079.0	6.0	4000
8.726-086.0	3.5	5000
8.726-087.0	4.0	5000
8.726-088.0	4.5	5000
8.726-089.0	5.0	5000
8.726-090.0	5.5	5000
8.726-091.0	6.0	5000

## NOZZLE PROTECTOR - ST-10



Ideal to protect sensitive surfaces against damage. Hard plastic body is stable enough to tightly hold nozzle adapter for heavy-duty use.



- Temperature: 300°F
- 1/4" FPT Inlet / Outlet

PART NO.	DESCRIPTION	TYPE
8.723-668.0	Red / Black	Zinc-plated
8.723-669.0	Black / Gray	Stainless-steel

## NOZZLES - TURBO - A+ NOZZLE KIT



- PSI: 4000
- With 8.726-069.0 Nozzle
- With 8.710-149.0 Inlet Filter



PART NO.	DESCRIPTION	PSI
8.928-444.0	A+ Turbo Nozzle #4 Kit	4000

**NOZZLES - MV ROTOJET 3700 & 5800 TURBO**

0° impact, 25° pattern, no gears - no teeth - no bearings. Exclusive design of the Rotojet 3700 / Rotojet 5800 eliminates start up impact and damage to internal nozzle.

- High-Strength, Forged Brass
- Precision Ceramic Orifice and Matching Race
- Durable Rubber / Plastic Cover
- 1/4" BSPP - \*Note: British pipe thread compatible in-line filters are 8.709-979.0 and 8.709-978.0



**ROTOJET 3700 PSI**

- Temperature: 210°F
- PSI: 1150 Min - 3700 Max



**ROTOJET 5800 PSI  
(MUST START WITH NOZZLE DOWN)**

- Temperature: 200°F
- PSI: 2600 Min - 5800 Max

PART NO.	ORIFICE	PSI
<b>NOZZLE</b>		
8.711-002.0	3.0	3700
8.711-003.0	3.5	3700
8.711-005.0	4.0	3700
8.711-004.0	4.5	3700
8.711-006.0	5.0	3700
8.711-008.0	5.5	3700
8.711-007.0	6.0	3700
8.711-009.0	3.0	5800
8.711-010.0	3.5	5800
8.711-011.0	4.0	5800
8.711-012.0	4.5	5800
8.711-013.0	5.0	5800
8.711-014.0	5.5	5800
8.711-015.0	6.0	5800
8.711-016.0	6.5	5800
8.711-017.0	7.0	5800
8.711-018.0	8.0	5800
8.711-019.0	9.0	5800
8.711-020.0	10.0	5800
8.711-023.0	11.0	5800
8.711-021.0	12.0	5800

PART NO.	ORIFICE	PSI
<b>REPAIR KIT</b>		
8.704-039.0	3.0	3700
8.704-038.0	3.5	3700
8.704-040.0	4.0	3700
8.704-041.0	4.5	3700
8.704-042.0	5.0	3700
8.704-043.0	5.5	3700
8.704-044.0	6.0	3700
8.704-066.0	3.5	5800
8.704-067.0	4.0	5800
8.704-068.0	4.5	5800
8.704-069.0	5.0	5800
8.704-070.0	5.5	5800
8.704-071.0	6.0	5800
8.704-072.0	6.5	5800
8.704-073.0	7.0	5800
8.704-074.0	8.0	5800
8.704-075.0	9.0	5800
8.704-076.0	10.0	5800
8.704-077.0	11.0	5800
8.704-078.0	12.0	5800

### NOZZLES - 3650 & 5100 PSI TURBO

Provides great impact and cleaning power

- Temperature: 212°F

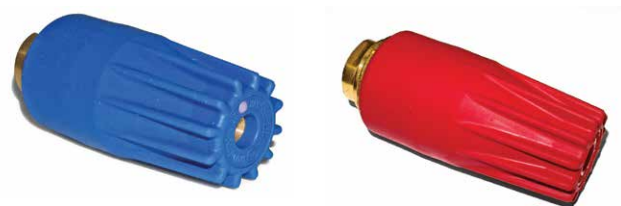

**Turbo Nozzle**  
PSI: 1150 Min - 3650 Max

**Turbo Nozzle**  
PSI: 2600 Min - 5100 Max

PART NO.	ORIFICE	PSI
<b>NOZZLE</b>		
8.711-105.0	3.0	3650
8.711-097.0	3.5	3650
8.711-098.0	4.0	3650
8.711-099.0	4.5	3650
8.711-100.0	5.0	3650
8.711-101.0	5.5	3650
8.711-102.0	6.0	3650
8.711-096.0	6.5	3650
8.711-103.0	7.0	3650
8.711-104.0	8.0	3650
8.711-086.0	3.0	5100
8.711-087.0	3.5	5100
8.711-088.0	4.0	5100
8.711-089.0	4.5	5100
8.711-090.0	5.0	5100
8.711-091.0	5.5	5100
8.711-092.0	6.0	5100
8.711-093.0	6.5	5100
8.711-094.0	7.0	5100
8.711-095.0	8.0	5100

PART NO.	DESCRIPTION
<b>REPAIR KIT - TURBO NOZZLES 3650 AND 5100 PSI</b>	
8.749-913.0	Repair Kit 3.5
8.749-914.0	Repair Kit 4.0
8.749-915.0	Repair Kit 4.5
8.749-916.0	Repair Kit 5.0
8.749-917.0	Repair Kit 5.5
8.749-920.0	Repair Kit 7.0
8.749-921.0	Repair Kit 8.0

### NOZZLES - ST-357 & ST-457 TURBO



- 1/4" FPT
- Forged Brass
- Precision Ceramic Orifice
- Rubber Cover / Protector



**ST-357**  
PSI: 1150 Min - 3652 Max  
Temperature: 190°F

**ST-457 - 6000 PSI**  
PSI: 2600 Min - 6000 Max  
Temperature: 212°F

PART NO.	ORIFICE	PSI
<b>NOZZLE</b>		
8.710-986.0	3.0	3625
8.710-987.0	3.5	3625
8.710-989.0	4.0	3625
8.710-988.0	4.5	3625
8.710-991.0	5.0	3625
8.710-993.0	5.5	3625
8.710-992.0	6.0	3625
8.711-072.0	3.0	6000
8.711-073.0	3.5	6000
8.711-074.0	4.0	6000
8.711-075.0	4.5	6000
8.711-076.0	5.0	6000
8.711-077.0	5.5	6000
8.711-078.0	6.0	6000
8.711-079.0	7.0	6000
8.711-080.0	8.0	6000
8.711-081.0	10.0	6000
<b>REPAIR KIT</b>		
8.701-570.0	3.0	3625
8.701-569.0	3.5	3625
8.701-564.0	4.0	3625
8.701-562.0	4.5	3625
8.701-565.0	5.0	3625
8.701-568.0	5.5	3625
8.701-566.0	6.0	3625
8.701-572.0	3.0	6000
8.701-571.0	3.5	6000
8.701-573.0	4.0	6000
8.701-574.0	4.5	6000
8.701-575.0	5.0	6000
8.701-576.0	5.5	6000
8.701-577.0	6.0	6000
8.701-578.0	7.0	6000
8.701-579.0	8.0	6000
8.701-580.0	10.0	6000

## NOZZLES

### NOZZLES - TURBO - IDK & DK SERIES - DIRT KILLER

4700 maximum PSI, a popular model providing great impact and cleaning power.



8.712-429.0

- Temperature Max: 180°F
- 1/4" Inlet
- IDK Series: Commonly used for Water Blasting and Heavy Duty Cleaning of Concrete, Steel, etc.
- DK Series: Commonly used for warehouse floors, wash rooms, alleyways etc.

PART NO.	SERIES	ORIFICE	PSI
<b>NOZZLE</b>			
8.712-429.0	DK	045	3200
8.740-148.0	IDK	055	4700
<b>REPAIR KIT</b>			
8.701-160.0	DK Kit	045	3200
8.701-161.0	IDK Kit	055	4700

### NOZZLES - TURBO MV ROTATING SOFT / HARD

The cleaning efficiency of a high-pressure rotating nozzle with the feature of changing from a hard spray for concrete to a soft spray for wood by simply pushing or pulling the finger protected nozzle.



- PSI: 3700
- Temperature: 200°F

PART NO.	ORIFICE	PSI
8.711-055.0	045	3700

### NOZZLES - VIPER ROTATING



- PSI: 5000
- Temperature Max: 190°F
- 1/4" FPT Inlet
- Weight: 1.0 oz.

PART NO.	STD NOZZLE EQUIV	PSI
<b>NOZZLE - VIPER</b>		
8.711-000.0	4.5	5000
8.711-001.0	5.5	5000
<b>REPAIR KIT</b>		
8.701-163.0	4.5	5000
8.701-166.0	5.5	5000

### NOZZLES - MV TRIPLE-FUNCTION

Provides three cleaning options: low-pressure for soap or chemical application; a 15° angle for high-pressure cleaning; and a rotating nozzle for maximum cleaning efficiency.



- PSI: 3000
- Temperature: 210°F

PART NO.	ORIFICE	PSI
8.711-068.0	040	3000

### NOZZLES - ZRMAX & ZROTOMAX ROTATING



- PSI: Up to 5800 Max
- Temperature Max: 176°F
- 1/4" FPT Inlet

- Weight: 9 oz..
- Replaceable Stainless-Steel Orifices



PART NO.	DESCRIPTION	STD NOZZLE EQUIV	GPM	PSI
8.711-035.0	ZROTOMAX1	4.5	2.1 - 2.6	1450 -3500
8.711-036.0	ZROTOMAX2	5.5	2.9 - 4.0	1450 -3500
8.711-037.0	ZROTOMAX3	6.5	4.2 - 5.5	1450 -3500
8.711-038.0	ZRMAX581	4.5	2.3 - 4.7	5800
8.711-039.0	ZRMAX583	6.5	3.3 - 6.6	5800
8.701-532.0	Repair Kit			

### COUPLERS - LANCE & NOZZLE COUPLERS

Changes MPT lance to FPT for mounting MPT nozzles.



PART NO.	DESCRIPTION
<b>BRASS</b>	
8.705-150.0	1/8" x 1/8"
8.705-155.0	1/4" x 1/8"
8.705-151.0	1/4" x 1/4"
<b>STEEL</b>	
8.710-713.0	1/8" x 1/8"
8.710-712.0	1/4" x 1/8"
8.710-714.0	1/4" x 1/4"

### NOZZLES - ROTOJET 2500

Economy turbo nozzle.



- PSI Max: 2000
- Temperature Max: 140°F
- 1/4" FPT Inlet
- Weight: 5.4 oz..
- Great for economy washers

PART NO.	ORIFICE	PSI
8.711-026.0	3.0	2500
8.711-027.0	3.5	2500

### NOZZLES - A+ MULTI-FAN

Adjust from maximum Impact Zero Stream to 80° wide-angle spray with a twist of the nozzle body.



- PSI: 3000
- Temperature: 300°F
- 1/4" FPT Connect
- Stainless-Steel Replaceable Orifices
- Stainless-Steel Deflector .

PART NO.	ORIFICE	COLOR
8.710-932.0	3.0	Yellow
8.710-933.0	3.5	White
8.710-934.0	4.0	Blue
8.710-935.0	4.5	Brown
8.710-936.0	5.0	Green
8.710-937.0	5.5	Light Blue
8.710-942.0	8.0	-

### NOZZLE FILTERS - 1/4" HIGH-PRESSURE

Turbo nozzle protector.



8.709-978.0



8.709-979.0



8.710-150.0



8.710-149.0

- PSI Max: 5000
- GPM: 8.0
- Temperature: 300°F
- 1/4" MPT Outlet
- 100-Mesh SS Screen

PART NO.	TYPE	INLET	OUTLET
8.709-978.0	Brass	1/4" FPT	1/4" MPT
8.709-979.0	Brass	1/4" QC	1/4" MPT
8.710-149.0	416 SS	1/4" QC	1/4" MPT
8.710-150.0	Brass	1/4" MPT	1/4" MPT
8.704-234.0	Replacement Filter for 8.709-978.0 / 8.709-979.0		
8.701-201.0	Replacement Filter for 8.710-149.0 / 8.710-150.0		

### NOZZLES - DUO-REG

Duo-Reg nozzles are designed for industrial use in ALL applications. Easy push / pull, low-to-high pressure change, and easy-turn to adjust from 0° to 80° fan pattern.



- PSI: 3200
- GPM: 8.0
- Temperature: 300°F
- 1/4" FPT Connect
- Stainless-Steel Replaceable Orifices
- Tough Glass-Filled Nylon Cover
- Compact Size: 3-3/8" Long, 1-3/16" Diameter
- Weight: 5.7 oz..

PART NO.	ORIFICE	COLOR
8.710-959.0	3.0	Yellow
8.710-960.0	3.5	White
8.710-961.0	4.0	Blue
8.710-962.0	4.5	Brown
8.710-963.0	5.0	Green
8.710-964.0	5.5	Sky
8.710-965.0	6.0	Black
8.710-966.0	6.5	Dark Green

## NOZZLES

### REPLACEMENT ORFICES

Replacement orifices for Duo-Reg and Multi-fan nozzles.



PART NO.	ORIFICE
8.701-448.0	1.20 MM = 3.0 GPM
8.701-452.0	1.25 MM = 4.5 GPM

### NOZZLE HOLDER / HEAD - ST-56 ROLLOVER



- PSI Max: 3600
- GPM: 8
- Temperature: 300°F
- 1/4" FPT Inlet and Outlet
- Brass Body
- Glass-Filled Polyimide Cover

PART NO.	DESCRIPTION	PSI
8.710-895.0	Rollover Nozzle Head	3600

### NOZZLE HOLDER - ST-51N ADJUSTABLE



Nozzle holder allows water to be diverted around the fixed orifice nozzle, dropping the pressure and allowing the chemical injector to operate.



- PSI Max: 3600
- Temperature Max: 300°F
- GPM Max: 8.0
- Attaches to 1/4" MPT Lance
- Accepts 1/4" Meg Nozzles
- Weight: 5.9 oz.

PART NO.	DESCRIPTION	PSI
8.710-889.0	ST-51N	3600

### NOZZLE HOLDER - ST-330 - SWIVELING



Perfect For cleaning hard-to-reach areas. Nozzle position locks with pressure.

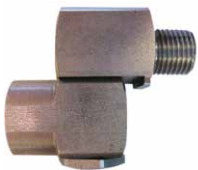

- PSI: 5070
- GPM: 10
- Temperature: 300°F
- Stainless-Steel
- 1/4" Female Inlet

PART NO.	DESCRIPTION
8.749-905.0	Outlet 1/4" FNPT
8.749-906.0	Outlet 1/4" Male

### NOZZLES - HL250 VARI HI-LOW ANGLE



Push / Pull for easy change between high- and low-pressure; simple twist to adjust 0° - 80° spray fan pattern.



- PSI Max: 4050
- Temperature: 195°F
- 1/4" FPT Inlet
- Weight: 4 oz..
- Glass-Filled Nylon Cover
- Stainless-Steel Replaceable Orifice

PART NO.	ORIFICE	COLOR
8.710-972.0	2.0	Light Green
8.710-973.0	2.5	Pink
8.710-974.0	3.0	White
8.710-975.0	3.5	Brown
8.710-976.0	4.0	Dark Yellow
8.710-977.0	4.5	Blue
8.710-978.0	5.0	Purple
8.710-979.0	5.5	Dark Red
8.710-980.0	6.0	Dark Green
8.710-982.0	7.0	Orange
8.710-983.0	8.0	Silver

### NOZZLE HOLDER - DOUBLE

Up to 10 GPM flow for low side pressure, 250 PSI.



- PSI Max: 3200
- Temperature Max: 195°F
- 1/4" Female Inlet, Two Female Outlets
- Heavy Nickel-Plate
- Chemical-Resistant
- Stainless-Steel Ball
- Machined-Brass Body
- New Ball Guide and Seat

PART NO.	DESCRIPTION	PSI
8.710-897.0	Double Nozzle Head	3200

### NOZZLE HOLDER - PIVOT



- Allowable 120° Pivoting
- Works with standard quick connect nozzles
- 1/4" Quick Connect plug x 1/4" Quick Connect Socket

PART NO.	DESCRIPTION	PSI
9.114-868.0	Pivoting Nozzle	4000

### X-JET LONG RANGE NOZZLE

Includes 15' Hose with In-Line Shut-Off Valve and Color-Coded Proportioners.



8.710-474.0

- Projects Water and Chemical Up To 40'
- Chemicals Bypass Pump, Lance, Hose and Gun For Damage Protection

PART NO.	DESCRIPTION
8.710-474.0*	X-Jet Long Range Nozzle, 2000-3000 PSI
8.710-475.0*	X-Jet Long Range Nozzle, 3000-4000 PSI
8.710-473.0	M5 X-Jet Variable Fan, 2000-3000 PSI, Long Range Nozzle

\*Includes Close Range Nozzle

### JROD MULTI-NOZZLE HOLDER

A handy tool that allows switching quickly between four different nozzles on one spray gun wand. Works great for changing between foam and water, reaching multiple height levels, or altering the intensity of the spray without having to carry around several individual nozzles



- 304 Stainless-steel
- Fits 1/4" NPT-M Thread Nozzles
- Turns each nozzle into a Quick-connect Tip

PART NO.	DESCRIPTION
9.112-496.0	JRod Multi-Nozzle Holder

### JROD MULTI-NOZZLE HOLDER



- Stainless-steel
- Fits 1/4" NPT-M Thread Nozzles
- Turns each nozzle into a Quick-connect Tip

PART NO.	DESCRIPTION
9.115-330.0	2-way JRod Multi-Nozzle Holder
9.115-396.0	4-way JRod Multi-Nozzle Holder

### NEW OFFERING NOZZLES - STEAM



PART NO.	DESCRIPTION
9.112-956.0	DSN14F Steam Nozzle, 1/4" NPT-F Drill-to-Size Brass with 2.0 Opening

### NOZZLES - STEAM



#### Steam Nozzle Blank

#### Flat Steam Nozzle

- PSI: 1450
- Steam Nozzle - 1/4" F

- Steam Blank - 3/8" M
- One-Piece Brass

PART NO.	DESCRIPTION
8.710-958.0	Flat Stream Nozzle, 1.5 mm
8.710-957.0	Steam Nozzle Blank, Drill to Size
8.904-374.0	Nozzle Blank, Drilled to 1.6 mm
8.712-415.0	Steam Nozzle, Drilled to 5/64"

### NOZZLES - ADJUSTABLE

Compact, full-feature unit weighs only 4.3 oz., same functions as ST-51N.



- PSI Max: 3650
- Temperature Max: 300°F
- GPM Max: 8.0
- Machined-Brass Body
- Nylon Adjustment Knob
- 1/4" FPT Inlet / Outlet

PART NO.	DESCRIPTION	PSI
8.710-891.0	Adjustable Nozzle	3650

### NOZZLES - GUM REMOVAL

Removes gum on concrete using a series of 0 degree jets



PART NO.	DESCRIPTION
9.115-328.0	Gum Remover, QC, .05 Red
9.115-329.0	Gum Remover, QC, .08 Red

**NOZZLES - LONG DISTANCE**



- PSI Max: 5000
- Temperature: 250°F
- Inlet 1/4" NPT-M
- 10 GPM
- Cleans surfaces from longer distances
- Robust stainless steel construction



PART NO.	DESCRIPTION
9.116-521.0	Nozzle, Long Distance #2.0
9.116-522.0	Nozzle, Long Distance #2.5
9.116-523.0	Nozzle, Long Distance #3.0
9.116-524.0	Nozzle, Long Distance #3.5
9.116-525.0	Nozzle, Long Distance #4.0
9.116-526.0	Nozzle, Long Distance #4.5
9.116-527.0	Nozzle, Long Distance #5.0
9.116-528.0	Nozzle, Long Distance #5.5
9.116-529.0	Nozzle, Long Distance #6.0
9.116-530.0	Nozzle, Long Distance #6.5
9.116-531.0	Nozzle, Long Distance #7.0
9.116-532.0	Nozzle, Long Distance #7.5
9.116-533.0	Nozzle, Long Distance #8.0
9.116-534.0	Nozzle, Long Distance #8.5
9.116-535.0	Nozzle, Long Distance #9.0
9.116-536.0	Nozzle, Long Distance #10.0

**NOZZLE HOLDER - ROLLOVER - TWIST TYPE**

Holds two meg nozzles on opposite sides for positive change from chemical application to high-pressure rinse.



- PSI Max: 1000
- Temperature: 180°F
- Nickel-Plated Brass Body

PART NO.	DESCRIPTION	PSI
8.710-893.0	Dual 1/4" FPT In / Out	1000
8.900-022.0	Repair Kit	1000

**NOZZLE PROTECTOR / COUPLER**



- Protect Nozzles and Finished Surfaces
- Deep Nozzle Recess
- Tough Plastic Protector
- 1/4" FPT Coupler Inlet

PART NO.	NOZZLE
8.710-866.0	1/8"
8.710-867.0	1/4"

**NOZZLE PROTECTOR - SLIP-ON**

A durable, easy-to-use nozzle protector. Plastic rubber compound - flexible and tough!



- 1-1/2" Diameter at Flare-End
- Slip-On to Lance
- Slip-Fits Standard Lances
- Attach Nozzle Coupler and Nozzle
- 2-1/2" Long
- Weight: 1.2 oz..
- Slide protector forward for complete nozzle protection

PART NO.	DESCRIPTION
8.710-868.0	Slip-on Nozzle Protector

**FOAMERS - LEGACY COMPACT**



Generates a high-density clinging foam for extended dwell time to increase chemical action.



- PSI Max: 2500
- Temperature Max: 195°F
- GPM Max: 1-5
- 4 and 6.5 Nozzle Included
- 5" Long, 1" Diameter
- Stainless-Steel, Aluminum and Brass

PART NO.	DESCRIPTION	PSI
8.903-998.0	1/8" F Inlet	2500
8.903-999.0	1/4" F Inlet	2500

Note: Most cleaning chemicals perform best when at 120° - 150°F and can be applied as a foam by adding a foaming agent. See your chemical supplier to obtain the correct products.

**FOAMERS - FOAM CANNON**

The ideal foam generator application accessory meters the foaming chemical for customized foam type and applies the foam to match the application.



- PSI Max: 3200
- Temperature Max: 140°F
- GPM Max: 6.5
- Brass Meter Valve
- 1/4" FPT Lance Connect
- High-Impact Glass-Filled Body
- Stainless-Steel 1.5 mm Orifice (#5.5 Nozzle Equivalent)
- Stainless-Steel Foam Turbulator

PART NO.	DESCRIPTION
8.710-125.0	Foam Cannon / Injector
8.710-126.0	Foam Cannon / Injector / Bottle
8.704-222.0	Replacement Turbulator Screen



## LEGACY HD PUMP - THE MOST DURABLE PUMP ON THE MARKET



Legacy HD heavy-duty, high pressure pumps are the outcome of years of research and development, resulting in a number of upgrades over previous pump models. Premium, long-life components and design features make the Legacy HD pump a standout among other high-pressure pumps. Tests prove it holds up better in rugged working conditions.

- Stronger crankcase housing with thicker aluminum cross members and mounting feet for added strength.
- Oil level dipstick is vented allowing for heat expansion. Oil level sight glass allows for quick and easy oil inspection.
- Crankcase features longer overall length to ensure less stress on all parts and a longer life of the pump.
- Premium European-quality tapered roller bearings on both the drive-side and opposite drive-side of the pump allow for heavier and demanding loads while greatly reducing noise levels and heat build-up.
- Super-strong, two-piece connecting rods designed with double-feeder grooves to maximize lubrication for a dramatically cooler running pump.
- Precision machined crankshafts for easy assembly and disassembly. Solid-shaft models have a full 55 mm shaft length to easily accept pulley and sheaves.
- Dacromet® finish on manifold bolts adds extra rust protection.
- Precision-ground and highly-polished solid ceramic plungers designed to withstand dramatic temperature and pressure spikes.
- Revolutionary forged-brass heads with exclusive "deep-well-sealing" valve caps eliminate any head pressure effects to the valve cap and valve cap thread.
- High-temperature, long life U-seals correctly fitted for each pump.
- Polished stainless-steel plunger rod reduces friction heat for a smoother and cooler operation.



## LEGACY HD PUMP - GX SERIES



The most durable pump on the market.



PART NO.	MODEL NO.	GPM	PSI	HP	RPM	SHAFT	WT (LBS.)
<b>GX SERIES: 1/2" INLET X 3/8" OUTLET</b>							
8.921-661.0	GX5450R	5.4	5000	17.0	1740	24 mm	43
8.921-662.0	GX5450L	5.4	5000	17.0	1740	24 mm	43
<b>GX SERIES: 3/4" BSP INLET X 1/2" BSP OUTLET</b>							
8.920-597.0	GX9536.2R	9.5	3625	23.6	1740	25 mm	38
8.920-598.0	GX9536.2L	9.5	3625	23.6	1740	25 mm	38
8.920-599.0	GX1036.2R	10.4	3625	25.8	1740	25 mm	38
8.920-600.0	GX1036.2L	10.4	3625	25.8	1740	25 mm	38
8.920-602.0	GX1622.2R	15.8	2200	23.8	1740	25 mm	38
8.920-603.0	GX1622.2L	15.8	2200	23.8	1740	25 mm	38
8.752.809.0	GX8043.2	7.9	4350	23.5	1740	25 mm	38

**LEGACY HD PUMP - GM SERIES**



■ Belt Drive

■ 1/2" Inlet x 3/8" Outlet



PART NO.	MODEL NO.	GPM	PSI	HP	RPM	SHAFT	WT (LBS.)
8.751-197.0	GM3540R.3	3.5	4000	9.5	1850	24 mm	22
8.751-198.0	GM4030R.3	4	3000	8.2	1000	24 mm	22
8.751-200.0	GM4035R.3	4.8	3500	7.5	1500	24 mm	22
8.751-201.0	GM4035L.3-Left	4.8	3500	7.5	1500	24 mm	22
8.751-202.0	GM5030R.3	5.1	3000	13.5	1550	24 mm	22
8.751-203.0	GM5030L.3	5.1	3000	13.5	1550	24 mm	22
8.751-244.0	GM6035R.3	5.6	3500	13.5	1740	24 mm	22
8.751-245.0	GM6035L.3	5.6	3500	13.5	1740	24 mm	22

**LEGACY HD PUMP - GT SERIES**



■ Belt Drive

■ 1/2" Inlet x 3/8" Outlet



PART NO.	MODEL NO.	GPM	PSI	HP	RPM	SHAFT	WT (LBS.)
8.921-722.0	GT4540.2R	4.5	4000	12.3	1360	25 mm	39
8.921-723.0	GT4540.2L	4.5	4000	12.3	1360	25 mm	39
8.921-724.0	GT6036.2R	6.0	3600	14.8	1450	25 mm	39
8.921-725.0	GT6036.2L	6.0	3600	14.8	1450	25 mm	39
8.921-726.0	GT5636.2R	5.6	3600	13.8	1450	24 mm	39
8.921-727.0	GT5636.2L	5.6	3600	13.8	1450	24 mm	39

**LEGACY PUMP - GBP & GB SERIES**



■ Belt Drive

■ 1/2" Inlet x 3/8" Outlet



PART NO.	MODEL NO.	GPM	PSI	HP	RPM	SHAFT	WT (LBS.)
8.929-708.0	GBP3030R	3.0	3000	6.2	1650	24 mm	14.5
8.929-754.0	GBP3030L	3.0	3000	6.2	1650	24 mm	14.5
8.929-713.0	GBP4025R	4.0	2500	6.8	1550	24 mm	14.5

**LEGACY HD PUMP - READY TO GO SERIES**



■ Belt or Direct Drive

■ Includes a pump, unloader, thermal protector, bypass loop hose, garden hose inlet with filter and quick coupler.



PART NO.	MODEL NO.	DRIVE	GPM	PSI	RPM	SHAFT	UNLOADER
8.924-458.0	GP3035G	Direct	3.0	3500	3400	3/4" Hollow	VRT3
8.924-459.0	GP3535G1	Direct	3.5	3500	3400	1" Hollow	VRT3
8.924-460.0	GS4040G.3	Direct	4.0	4000	3400	1" Hollow	VRT3
8.924-461.0	GB3030R	Belt	3.0	3000	1650	24 mm	VRT3
8.924-462.0	GM3540R.3	Belt	3.5	4000	1850	24 mm	VRT3
8.924-463.0	GM3840R.3	Belt	3.8	4000	1740	24 mm	VRT3

### LEGACY PUMP - HFR SERIES



■ Belt Drive

■ Rated up to 149°F

■ 3/4" Outlet



PART NO.	MODEL NO.	GPM	PSI	HP	RPM	SHAFT	INLET	WT (LBS.)
8.751-677.0	HFR40FR	10.5	4100	28.7	1450	40 mm	1"	106
8.751-678.0	HFR60FR	15.7	4100	43.0	1450	40 mm	1"	106
8.751-680.0	HFR80FL	20.9	4100	57.3	1450	40 mm	1"	106
8.751-681.0	HFR80FR	20.9	4100	57.3	1450	40 mm	1"	106
8.751-689.0	HFR80SR	21.1	2175	30.5	2175	40 mm	1-1/4"	106
8.751-693.0	HFR120SR	31.7	2175	46.1	2175	40 mm	1-1/4"	106

### LEGACY PUMP - HHP SERIES

"Eco brass" pump head: environment-friendly brass alloy with very high mechanical properties equivalent to Stainless-steel 316.



■ Belt Drive

■ Rated up to 149°F

■ 3/4" Inlet x 1/2" Outlet



PART NO.	MODEL NO.	GPM	PSI	HP	RPM	SHAFT	WT (LBS.)
8.751-682.0	HHP25SL	6.6	7250	32.6	1000	40 mm	112
8.751-694.0	HHP4150R	10.8	7250	53.7	1450	40 mm	112

### LEGACY PUMP - NMT SERIES



■ Belt Drive

■ 1/2" Inlet x 3/8" Outlet

■ NMT1520SCWR:  
Rated up to 149°F Nickel Plated

■ NMT2120ESR:  
Rated up to 185°F Stainless-steel - 316L

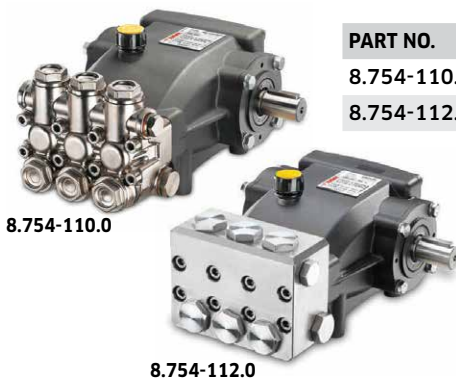

8.754-110.0

8.754-112.0

PART NO.	MODEL NO.	GPM	PSI	HP	RPM	SHAFT	WT (LBS.)
8.754-110.0	NMT1520SCWR	4.8	3000	9.9	1200	24 mm	21
8.754-112.0	NMT2120ESR	6.6	3000	12.8	1740	24 mm	26

### LEGACY PUMP - NLT SERIES



■ Belt Drive

■ Rated up to 149°F

■ 1/2" Inlet x 3/8" Outlet

■ Double Shaft Pump



PART NO.	MODEL NO.	GPM	PSI	HP	RPM	SHAFT	WT (LBS.)
8.755-731.0	NLT2525S	7.9	3625	19.6	1200	25 mm	41

**LEGACY HD PUMP - GS SERIES**



- Direct Couple-to-gas Engine
- 1/2" Inlet x 3/8" Outlet



PART NO.	MODEL NO.	GPM	PSI	HP	RPM	SHAFT	WT (LBS.)
8.751-205.0	GS3040G.3	3.0	4000	9.0	3400	1" Hollow	24.5
8.751-206.0	GS3540G.3	3.5	4000	11.0	3400	1" Hollow	23
8.751-207.0	GS4040G.3	4.0	4000	13.0	3400	1" Hollow	23
8.751-208.0	GS5030G.3	5.0	3000	16.0	3400	1" Hollow	24.5

**LEGACY HD PUMP - GP & GPP SERIES**



- Direct Couple-to-gas Engine
- 1/2" Inlet x 3/8" Outlet



PART NO.	MODEL NO.	GPM	PSI	HP	RPM	SHAFT	WT (LBS.)
8.929-711.0	GPP2535G	2.5	3500	6.0	3400	3/4" Hollow	16.75
8.929-709.0	GPP3035G	3.0	3500	7.2	3400	3/4" Hollow	16.75
8.929-710.0	GPP3035G1	3.0	3500	7.2	3400	1" Hollow	18
8.923-816.0	GP3535G1	3.5	3500	8.4	3400	1" Hollow	18

**LEGACY HD PUMP - GF & GFP SERIES**



- Direct Couple-to-electric Motor
- NEMA 56C Frame
- 1/2 - 14 BSPP-F Inlet x 3/8-19 BSPP-F Outlet



PART NO.	MODEL NO.	GPM	PSI	HP	RPM	SHAFT	WT (LBS.)
8.923-818.0	GF2030F	2.1	3000	4.3	3450	5/8" Hollow	17
8.929-707.0	GFP2030S	2.1	3000	4.3	1725	5/8" Hollow	17
8.923-820.0	GF2830F	2.8	3000	5.8	3450	5/8" Hollow	17
8.929-714.0	GFP2830S	2.8	3000	5.8	1725	5/8" Hollow	17
8.929-712.0	GFP3530F	3.5	3000	7.2	3450	3/4" Hollow	17

**LEGACY HD PUMP - FOG NEMA SERIES**



- Direct Couple-to-electric Motor
- Rated up to 149°F
- 3/8 - 19 BSPP-F Inlet x 3/8-19 BSPP-F Outlet
- NEMA 56C Frame



PART NO.	MODEL NO.	GPM	PSI	HP	RPM	SHAFT	WT (LBS.)
8.754-501.0	FOG1214R	1.2	1450	1.2	1740	5/8" Hollow	12
8.754-502.0	FOG1914R	1.9	1450	1.9	1740	5/8" Hollow	12
8.754-503.0	FOG2514R	2.5	1450	2.5	1740	5/8" Hollow	12

### LEGACY HD PUMP - HY SERIES



- Direct Couple-to-gas Engine
- Rated up to 149°F
- 1/2" Inlet x 3/8" Outlet
- Ideal for Hydraulic Motors



PART NO.	MODEL NO.	GPM	PSI	HP	RPM	SHAFT	WT (LBS.)
8.754-984.0	HY1515HYR	4	2000	5.5	1450	5/8" Hollow	16.75
8.754-985.0	HY1520HYR	4	3000	8.2	1450	5/8" Hollow	16.75

### LEGACY PUMP - TML SERIES



- Belt Drive
- Rated up to 149°F
- 1/2" Inlet x 3/8" Outlet
- Industrial Triplex Plunger Pump with AI Connecting Rods
- Compare to General Pumps: TS Series  
AR Pumps: RK Series



PART NO.	MODEL NO.	GPM	PSI	RPM	SHAFT	WT (LBS.)
8.703-382.0	TML-3053	5.3	3000	1450	24 mm	18.9
8.703-457.0	Pump Rail Set (Kit)					

Note: Can be run at 1750 RPM. Please note the pump ships without rails

### LEGACY PUMP - TTV SERIES



- Belt Drive
- Rated up to 149°F
- 3/4" Inlet x 3/8" Outlet
- Heavy industrial Triplex Plunger Pump with AI Connecting Rods
- Compare to General Pumps: TS Series  
AR Pumps: RK Series



PART NO.	MODEL NO.	GPM	PSI	RPM	SHAFT	WT (LBS.)
8.703-387.0	TTV-3555	5.5	3500	1450	24 mm	18.9
8.703-388.0	TTV-3563	6.3	3500	1450	24 mm	20

Note: Can be run at 1750 RPM. Please note the pump ships without rails

### LEGACY PUMP - KKV SERIES



- Belt Drive
- Rated up to 149°F
- 1" Inlet x 1/2" Outlet
- Heavy industrial Triplex Plunger Pump with AI Connecting Rods



PART NO.	MODEL NO.	GPM	PSI	RPM	SHAFT	WT (LBS.)
8.703-391.0	KKV-3087	8.7	3000	1725	30 mm	39.6

Please note the pump ships without rails

**LEGACY PUMP - WJG SERIES**



- Direct Drive
- Rated up to 149°F
- SAE Flange
- 3/8" Inlet x 3/8" Outlet
- Triplex Plunger Pump with Bronze Connecting Rods
- Compare to General Pumps: TS Series  
AR Pumps: XTV Series



PART NO.	MODEL NO.	GPM	PSI	RPM	SHAFT	WT (LBS.)
8.703-342.0	WJG-2525	2.5	2500	3450	3/4" Hollow	13.2

**LEGACY PUMP - WJH-F & WJH SERIES**



**WJH-F Series**

- Direct Drive
- Rated up to 149°F
- NEMA Flange
- 3/8" Inlet x 3/8" Outlet
- Triplex Plunger Pump with Bronze Connecting Rods
- Compare to General Pumps: TS Series  
AR Pumps: XTV Series

**WJH Series**

- Direct Drive
- Rated up to 149°F
- NEMA Flange
- 3/8" Inlet x 3/8" Outlet
- Triplex Plunger Pump with AI Connecting Rods
- Compare to General Pumps: T and TT Series  
AR Pumps: XTA Series



PART NO.	MODEL NO.	GPM	PSI	RPM	SHAFT	WT (LBS.)
<b>WJH-F SERIES</b>						
8.703-346.0	WJH-2525-F	2.5	2500	3450	5/8" Hollow	13.2
<b>WJH SERIES</b>						
8.703-348.0	WJH-2121	2.1	2100	1725	5/8" Hollow	13.2
8.703-349.0	WJH-2132	3.2	2100	1725	5/8" Hollow	13.2

**LEGACY PUMP - WMG SERIES**



- Direct Drive
- Rated up to 149°F
- SAE Flange
- 1/2" Inlet x 3/8" Outlet
- Triplex Plunger Pump with Bronze Connecting Rods
- Compare to General Pumps: TS Series  
AR Pumps: XMV Series



PART NO.	MODEL NO.	GPM	PSI	RPM	SHAFT	WT (LBS.)
8.703-351.0	WMG-2530	3.0	2500	3450	3/4" Hollow	14.7

## LEGACY PUMP - WMG 1 SERIES



- Direct Drive
- Rated up to 149°F
- SAE Flange
- 1/2" Inlet x 3/8" Outlet
- Premium Triplex Plunger Pump with Bronze Connecting Rods
- Compare to General Pumps: TX Series  
AR Pumps: XMV Series



PART NO.	MODEL NO.	GPM	PSI	RPM	SHAFT	WT (LBS.)
8.703-356.0	WMG-3540	4.0	3500	3450	1" Hollow	14.7

## LEGACY PUMP - TMH SERIES



- Direct Drive
- NEMA Flange
- 1/2" Inlet x 3/8" Outlet
- Rated up to 149°
- Industrial Triplex Plunger Pump with Al Connecting Rods
- Compare to General Pumps: EZ Series  
AR Pumps: RKA Series



PART NO.	MODEL NO.	GPM	PSI	RPM	SHAFT	WT (LBS.)
8.703-375.0	TMH-3035	3.5	3000	1725	1-1/8" Hollow	18.9
8.703-376.0	TMH-3040	4.0	3000	1725	1-1/8" Hollow	18.9
8.703-377.0	TMH-3050	5.0	3000	1725	1-1/8" Hollow	18.9
8.703-378.0	TMH-3055	5.5	3000	1725	1-1/8" Hollow	18.9

## LEGACY PUMP



PART NO.	GPM	PSI	RPM	SHAFT	DESCRIPTION
<b>HORIZONTAL PUMP</b>					
8.930-514.0*	2.6	3000	3400	3/4"	
<b>VERTICAL PUMP</b>					
8.925-069.0	2.6	3000	3400	7/8"	With Garden Hose Fitting Inlet

\*Note: Can be used to replace Comet pumps listed on page 232.

## PUMP RAILS - LEGACY & LEGACY HD



PART NO.	DESCRIPTION
8.900-757.0	Rails for Models: KKV, TMH, TML, TTV, WJG, WJH, WJH-F, WMG, & WMG-1
8.717-577.0	Rails for Models: FGP, FOG, GF, GB, GBP, GM, GP, GPP, GS, GT, GX, HFR, HY, NLT, & NMT
9.802-744.0	Mounting Bolts for Models: FGP, FOG, GF, GB, GBP, GM, GP, GPP, GS, GT, GX, HFR, HHP, HY, NLT, & NMT

**LEGACY PUMP REPAIR KIT SELECTION CHART**



PUMP MODEL SERIES	MM	CHECK VALVE KIT	PLUNGER ROD OIL SEAL KIT	WATER SEAL(S) ONLY KIT	WATER SEALS(S) BRASS RING KIT	VALVE CAP KIT	ACCESSORY SEAL KIT
HDL	18	Kit 93	Kit 37	Kit 95	Kit 96	Kit 94	Kit 98
HG	15	Kit 84	Kit 64	Kit 129	Kit 92	Kit 66	N/A
KKV	22	Kit 40	Kit 37	Kit 90	Kit 87	Kit 132	Kit 98
KKV	25	Kit 40	Kit 37	Kit 91	Kit 88	Kit 100	Kit 98
KTV	20	Kit 123	Kit 37	Kit 89	Kit 86	Kit 99	Kit 98
TMG	15	Kit 123	Kit 65	Kit 74	Kit 69	Kit 67	Kit 78
TMH	18	Kit 123	Kit 65	Kit 76	Kit 71	Kit 67	Kit 78
TML	18	Kit 123	Kit 65	Kit 76	Kit 71	Kit 67	Kit 77
TML-F	15	Kit 123	Kit 65	Kit 74	Kit 69	Kit 67	Kit 77
TMS	18	Kit 123	Kit 65	Kit 76	Kit 71	Kit 67	Kit 77
TTV	20	Kit 123	Kit 37	Kit 89	Kit 86	Kit 67	Kit 127
WJG	15	Kit 84	Kit 64	Kit 60	Kit 61	Kit 66	Kit 82
WJH-F	15	Kit 84	Kit 64	Kit 60	Kit 61	Kit 66	Kit 82
WJH	18	Kit 84	Kit 64	Kit 12	Kit 10	Kit 66	Kit 82
WMG-3/4"	15	Kit 124	Kit 64	Kit 73	Kit 68	Kit 67	Kit 80
WMG-1"	15	Kit 124	Kit 64	Kit 73	Kit 68	Kit 67	Kit 79
WMH-F	15	Kit 124	Kit 64	Kit 73	Kit 68	Kit 67	Kit 80
WMH	18	Kit 63	Kit 64	Kit 12	Kit 70	Kit 67	Kit 80
WML	18	Kit 63	Kit 64	Kit 12	Kit 70	Kit 67	Kit 81

**LEGACY PUMP REPAIR TOOL KIT**



9.802-954.0 pump repair tool kit shown.

PART NO.	DESCRIPTION
9.802-954.0	Legacy Pump Repair Tool Kit (For all models except GB, GP, GP1, GF)
8.756-590.0	Legacy Pump Repair Tool Kit for Normal Maintenance (For models: GB, GP, GP1 and HY)
8.756-717.0	Legacy Pump Repair Tool Kit for Oil Seal Maintenance (For models: GB, GP, GP1 and HY)
8.758-163.0	Legacy Packing & Pulling Pump Repair Tool Kit (For models: GT.2 & GX.2)

PART NO.	DESCRIPTION
9.802-564.0	Guide, Oil Seal Inserter, Plunger Rod GT-GX-GH
9.802-581.0	Piston, Oil Seal Inserter, Plunger Rod GT-GX-GH
9.802-580.0	Piston, Oil Seal Inserter, Plunger Rod GM-GD-GG-GE-GS
9.802-563.0	Guide, Oil Seal Inserter, Plunger Rod GM-GD-GG-GE-GS
9.802-571.0	Allen Wrench 8 mm, Manifold Bolts GT-GX-GH
9.802-567.0	Allen Wrench 6 mm, Manifold Bolts GM-GD-GG-GE-GS
9.802-570.0	Allen Wrench 5 mm, Crankcase Cover
9.802-565.0	Guide, Oil Seal Inserter, Crankshaft GT-GX-GH
9.802-566.0	Guide, Oil Seal Insert, Crankshaft GM-GD-GG-GE-GS
9.802-568.0	Piston Seal Extractor

PART NO.	DESCRIPTION
9.802-579.0	Piston, Seal Inserter, Manifold GM-GS
9.802-573.0	Guide, Seal Inserter, Manifold GM-GS
9.802-578.0	Piston, Seal Inserter, Manifold GT
9.802-572.0	Guide, Seal Inserter, Manifold GT
8.751-396.0	Guide, Seal Inserter, Manifold GD-GE-GG
8.751-404.0	Guide, Seal Inserter, Manifold GX5050
8.751-397.0	Piston, Seal Inserter, Manifold GD-GE-GG-GH-GX
8.751-405.0	Guide, Seal Inserter, Manifold GH-GX
9.802-569.0	Hammer, Plastic Head
8.751-403.0	Screwdriver Flathead
9.802-574.0	Box, Plastic Tool Box



## LEGACY PUMP REPAIR KITS



PART NO.	KIT NO.	DESCRIPTION	NO. OF PIECES	QTY NEEDED PER PUMP
8.703-458.0	Kit 10	WJH Packing / Header / Brass Assy, 18 mm	21	1
8.703-459.0	Kit 12	WM - H&L Packing Kit WJH Packing / Header only, 18 mm	15	1
9.803-041.0	Kit 22	APR.S Unloader Seal(s) Kit	14	1
8.703-461.0	Kit 37	TTV-KTV-HDL Plunger Oil Seal Kit	3	1
8.703-462.0	Kit 40	KKV Check Valves / O-ring Kit	12	1
8.932-979.0	Kit 42	APR.S Unloader Valve Seal Kit	3	1
8.900-701.0	Kit 60	V-Packing, 15 mm Legacy Pump WJH, WJH - F&G Packing / Header only, 15 mm	12	1
8.900-702.0	Kit 61	Complete Plunger Set 15 mm 18 PX WJH - F&G Packing / Header / Brass, 15 mm	18	1
8.703-464.0	Kit 63	WMH&L Check Valve / O-ring Kit	12	1
8.703-465.0	Kit 64	HG / WJ / WM Plunger Oil Seal Kit	3	1
8.703-466.0	Kit 65	TM Plunger Oil Seal Kit	3	1
8.703-467.0	Kit 66	HG / WJ Valve Cap / O-ring, M18 x 1.5 Kit	12	1
8.703-468.0	Kit 67	WM / TM / TTV Valve Cap / O-ring, M27 x 1.5	12	1
8.703-469.0	Kit 68	WM - F&G Packing / Brass Assy Kit, 15 mm	21	1
8.703-470.0	Kit 69	TM - F&G Packing / Brass Assy, 15 mm	21	1
8.703-471.0	Kit 70	WM - H&L Packing / Brass Assy Kit, 18 mm	21	1
8.703-472.0	Kit 71	TM - H&L Packing / Brass Assy Kit, 18 mm	24	1
8.703-456.0	Kit 72	WML Pump Rail Kit (Foot, Spacer, Bolt)	8	1
8.703-474.0	Kit 73	WM - F&G Packing only Kit, 15 mm	15	1
8.703-475.0	Kit 74	TM - F&G Packing only Kit, 15 mm	15	1
8.703-476.0	Kit 76	TM - H&L Packing only Kit, 18 mm	18	1
8.703-479.0	Kit 79	WM-G 1" Accessory Seals Kit	8	1
8.703-483.0	Kit 84	HG / WJ Check Valve / O-ring	12	1
8.703-485.0	Kit 86	TTV-KTV Packing / Brass Assy Kit, 20 mm	24	1
8.703-486.0	Kit 87	KKV Packing / Brass Assy Kit, 22 mm	24	1
8.703-488.0	Kit 89	TTV-KTV Packing only Kit, 20 mm	18	1
8.703-489.0	Kit 90	KKV Packing only Kit L90, 22 mm	18	1
8.703-492.0	Kit 93	HDL Check Valve / O-ring	12	1
8.703-493.0	Kit 94	HDL Valve Containment Kit L94	24	1
8.900-703.0	Kit 95	HDL Packing only Kit L90, 18 mm	18	1
8.703-494.0	Kit 96	HDL Packing / Brass Assy Kit, 18 mm	24	1
8.703-498.0	Kit 123	TM-TTV-KTV Check Valve / O-ring Kit	12	1
8.703-499.0	Kit 124	WM - F&G Check Valve / O-ring Kit	12	1
8.703-501.0	Kit 127	TTV Accessory Oil Seal Kit	10	1
8.703-502.0	Kit 129	HG Packing only Kit, 15 mm	12	1

**ADMIRAL PUMP REPAIR KITS**

For the following Admiral pumps: WE Series, XD Series, XLS Series, CA Series, WG Series, XLE Series, XLG Series, C Series, IB Series.

<b>PART NO.</b>	<b>KIT NO.</b>	<b>DESCRIPTION</b>	<b>QTY NEEDED PER PUMP</b>
8.900-631.0	Kit AP1	Check Valves <i>(for WE, WG, WEL, XL Series, XD Small Brass Head)</i>	1
8.900-632.0	Kit AP2	Brass Valve Covers <i>(for WE, WG, WEL Series and XD Small Brass Head)</i>	1
8.900-633.0	Kit AP4	Oil Seals 15 mm Plunger Rod <i>(for WE, WG and WEL Series)</i>	1
8.900-634.0	Kit AP5	Oil Seals 18 mm Plunger Rod <i>(for XL Series)</i>	1
8.900-636.0	Kit AP7	Male Adapter Rings, 18 mm <i>(for WEL, XLE and XLS Series)</i>	1
8.900-637.0	Kit AP8	V-Packing Seals, 18 mm <i>(for WE and WG Series)</i>	1
8.900-643.0	Kit AP14	Brass Packing Gland, Two Piece, 18 mm <i>(For XLE and XLS Series)</i>	1
8.900-644.0	Kit AP15	V-Packing Seals, Two Piece, 18 mm <i>(for XLE and XLS Series)</i>	1
8.900-645.0	Kit AP16	Super U-Packing Seals, 18 mm <i>(for XLG Series only)</i>	1
8.900-646.0	Kit AP17	Complete Plunger Seal, Two Piece, 18 mm <i>(for XLE and XLS Series)</i>	3
8.900-647.0	Kit AP18	Complete Plunger Seal, Super-U, 18 mm <i>(for XLG Series only)</i>	3
8.900-648.0	Kit AP19	Brass Packing Gland, Super-U, 18 mm <i>(for XLG Series only)</i>	1
8.900-652.0	Kit AP23	Low Pressure Seals, 18 mm <i>(for XL Series)</i>	1
8.900-653.0	Kit AP24	V-Packing Seals, 15 mm, Two Piece <i>(for WE-T and WG-T Series)</i>	1
8.900-654.0	Kit AP25	V-Packing Seals, 18 mm, Two Piece <i>(for WE-T Series only)</i>	1
8.900-657.0	Kit AP28	Complete Plunger Seal, 15 mm, Two Piece <i>(for WE-T and WG-T Series)</i>	3
8.900-666.0	Kit AP38	"Super U" Packing <i>(for XD 20 mm)</i>	1
8.900-676.0	Kit AP52	Check Valve Assemblies <i>(for IB-1000 Series and CA Series)</i>	1
8.900-680.0	Kit AP57	Male Adapter Rings, 45 mm <i>(for IB-1000 Series C and CA Series)</i>	1
8.900-682.0	Kit AP59	V-Packing Seals, 45 mm <i>(for IB-1000 Series C and CA Series)</i>	1
8.900-683.0	Kit AP61	Glands (45 mm), Brass Packing <i>(for IB-1019, 1032, 1037, C and CA Series)</i>	1

## LEGACY HD PUMP REPAIR KIT SELECTION CHART

FOR 

Use the selection chart below and on the following 2 pages to find the correct and quantity repair kits needed for a specific Legacy HD Pump Model.

PUMP MODEL	SEAL KIT (QTY / PUMP)	COMPLETE SEAL KIT (QTY / PUMP)	CERAMIC PLUNGER KIT (QTY / PUMP)	VALVE KIT (QTY / PUMP)	PLUNGER OIL SEAL KIT (QTY / PUMP)
FOG0614R	N/A	8.754-575.0 (3)	8.754-576.0 (3)	8.754-577.0 (6)	8.754-578.0 (1)
FOG1214R	N/A	8.754-575.0 (3)	8.754-576.0 (3)	8.754-577.0 (6)	8.754-578.0 (1)
FOG1914R	N/A	8.754-575.0 (3)	8.754-576.0 (3)	8.754-577.0 (6)	8.754-578.0 (1)
FOG2514R	N/A	8.754-575.0 (3)	8.754-576.0 (3)	8.754-577.0 (6)	8.754-578.0 (1)
GB3030L	8.754-856.0 (1)	8.758-081.0 (1)	8.754-858.0 (3)	8.754-859.0 (1)	9.803-937.0 (1)
GB3030R	8.754-856.0 (1)	8.758-081.0 (1)	8.754-858.0 (3)	8.754-859.0 (1)	9.803-937.0 (1)
GB4025L	8.754-856.0 (1)	8.758-081.0 (1)	8.754-858.0 (3)	8.754-859.0 (1)	9.803-937.0 (1)
GB4025R	8.754-856.0 (1)	8.758-081.0 (1)	8.754-858.0 (3)	8.754-859.0 (1)	9.803-937.0 (1)
GBP3030R	8.759-015.0 (1)	8.929-348.0 (1)	8.754-858.0 (3)	8.754-859.0 (1)	9.803-937.0 (1)
GBP3030L	8.759-015.0 (1)	8.929-348.0 (1)	8.754-858.0 (3)	8.754-859.0 (1)	9.803-937.0 (1)
GBP4025R	8.759-015.0 (1)	8.929-348.0 (1)	8.754-858.0 (3)	8.754-859.0 (1)	9.803-937.0 (1)
GD3025	8.725-356.0 (1)	8.725-357.0 (3)	9.803-935.0 (3)	9.803-936.0 (1)	9.803-937.0 (1)
GD3030	8.725-354.0 (1)	8.725-355.0 (3)	9.803-934.0 (3)	9.803-936.0 (1)	9.803-937.0 (1)
GD4020.1	8.725-356.0 (1)	8.725-357.0 (3)	9.803-935.0 (3)	9.803-936.0 (1)	9.803-937.0 (1)
GE2020F.1	8.725-354.0 (1)	8.725-355.0 (3)	9.803-934.0 (3)	9.803-936.0 (1)	9.803-937.0 (1)
GE2020S.1	8.725-356.0 (1)	8.725-357.0 (3)	9.803-935.0 (3)	9.803-936.0 (1)	9.803-937.0 (1)
GE2825F.1	8.725-354.0 (1)	8.725-355.0 (3)	9.803-934.0 (3)	9.803-936.0 (1)	9.803-937.0 (1)
GE2825S.1	8.725-356.0 (1)	8.725-357.0 (3)	9.803-935.0 (3)	9.803-936.0 (1)	9.803-937.0 (1)
GE3525F.1	8.725-354.0 (1)	8.725-355.0 (3)	9.803-934.0 (3)	9.803-936.0 (1)	9.803-937.0 (1)
GF2030F	8.754-860.0 (1)	8.725-357.0 (3)	8.754-862.0 (3)	8.754-859.0 (1)	9.803-937.0 (1)
GF2030S	8.754-856.0 (1)	8.725-355.0 (3)	8.754-858.0 (3)	8.754-859.0 (1)	9.803-937.0 (1)
GF2830F	8.754-860.0 (1)	8.758-083.0 (1)	8.754-862.0 (3)	8.754-859.0 (1)	9.803-937.0 (1)
GF2830S	8.754-856.0 (1)	8.758-081.0 (1)	8.754-858.0 (3)	8.754-859.0 (1)	9.803-937.0 (1)
GF3530F	8.754-860.0 (1)	8.758-0830 (1)	8.754-862.0 (3)	8.754-859.0 (1)	9.803-937.0 (1)
GFP2030S	8.759-015.0 (1)	8.929-348.0 (1)	8.754-858.0 (3)	8.754-859.0 (1)	9.803-937.0 (1)
GFP2830S	8.759-015.0 (1)	8.929-348.0 (1)	8.754-858.0 (3)	8.754-859.0 (1)	9.803-937.0 (1)
GFP3530F	8.759-031.0 (1)	8.758-218.0 (1)	8.754-862.0 (3)	8.754-859.0 (1)	9.803-937.0 (1)
GG2530G.1	8.725-354.0 (1)	8.758-081.0 (1)	9.803-934.0 (3)	9.803-936.0 (1)	9.803-937.0 (1)
GG3030G.1	8.725-354.0 (1)	8.758-083.0 (1)	9.803-934.0 (3)	9.803-936.0 (1)	9.803-937.0 (1)
GG3035G1.1	8.725-354.0 (1)	8.725-355.0 (3)	9.803-934.0 (3)	9.803-936.0 (1)	9.803-937.0 (1)
GG4030G1.1	8.725-354.0 (1)	8.725-355.0 (3)	9.803-934.0 (3)	9.802-604.0 (1)	9.802-606.0 (1)
GH5050	9.804-492.0 (1)	9.804-493.0 (3)	9.802-629.0 (3)	9.802-603.0 (1)	9.802-609.0 (1)
GM3540.2	8.725-358.0 (1)	8.758-087.0 (1)	8.933-023.0 (3)	9.802-603.0 (1)	9.802-609.0 (1)
GM3540.3	8.725-358.0 (1)	8.758-087.0 (1)	8.933-023.0 (3)	9.802-603.0 (1)	9.802-609.0 (1)
GM4030.2	8.725-362.0 (1)	8.758-086.0 (1)	9.802-620.0 (3)	9.802-603.0 (1)	9.802-609.0 (1)
GM4030.3	8.725-362.0 (1)	8.758-086.0 (1)	8.751-238.0 (3)	9.802-603.0 (1)	9.802-609.0 (1)
GM4035.2	8.725-360.0 (1)	8.758-085.0 (1)	9.802-629.0 (3)	9.802-603.0 (1)	9.802-609.0 (1)
GM4035.3	8.725-360.0 (1)	8.758-085.0 (1)	8.751-237.0 (3)	9.802-603.0 (1)	9.802-609.0 (1)
GM5030.2	8.725-362.0 (1)	8.758-086.0 (1)	9.802-620.0 (3)	9.802-603.0 (1)	9.802-609.0 (1)
GM6035.2	8.725-360.0 (1)	8.758-085.0 (1)	9.802-629.0 (3)	9.802-603.0 (1)	9.802-609.0 (1)
GM6035.3	8.725-360.0 (1)	8.758-085.0 (1)	8.751-237.0 (3)	9.802-603.0 (1)	9.802-609.0 (1)
GP2535G	8.754-860.0 (1)	8.758-083.0 (1)	8.754-862.0 (3)	8.754-859.0 (1)	9.803-937.0 (1)
GP3035G	8.754-860.0 (1)	8.758-083.0 (1)	8.754-862.0 (3)	8.754-859.0 (1)	9.803-937.0 (1)
GP3035G1	8.754-860.0 (1)	8.758-083.0 (1)	8.754-862.0 (3)	8.754-859.0 (1)	9.803-937.0 (1)

**LEGACY HD PUMP REPAIR KIT SELECTION CHART (CONTINUED)**



Use the selection chart below and on the preceding and following page to find the correct and quantity repair kits needed for a specific Legacy HD Pump Model.

<b>PUMP MODEL</b>	<b>SEAL KIT (QTY / PUMP)</b>	<b>COMPLETE SEAL KIT (QTY / PUMP)</b>	<b>CERAMIC PLUNGER KIT (QTY / PUMP)</b>	<b>VALVE KIT (QTY / PUMP)</b>	<b>PLUNGER OIL SEAL KIT (QTY / PUMP)</b>
GP3535G1	8.754-860.0 (1)	8.758-083.0 (1)	8.754-862.0 (3)	8.754-859.0 (1)	9.803-937.0 (1)
GP4035G1	8.754-860.0 (1)	8.758-083.0 (1)	8.754-862.0 (3)	8.754-859.0 (1)	9.803-937.0 (1)
GPP2535G	8.759-031.0 (1)	8.758-218.0 (1)	8.754-862.0 (3)	8.754-859.0 (1)	9.803-937.0 (1)
GPP3035G	8.759-031.0 (1)	8.758-218.0 (1)	8.754-862.0 (3)	8.754-859.0 (1)	9.803-937.0 (1)
GPP3035G1	8.759-031.0 (1)	8.758-218.0 (1)	8.754-862.0 (3)	8.754-859.0 (1)	9.803-937.0 (1)
GS3040G.2	8.725-358.0 (1)	8.758-087.0 (1)	8.933-023.0 (3)	9.802-603.0 (1)	9.802-609.0 (1)
GS3040G.3	8.725-358.0 (1)	8.758-087.0 (1)	8.933-023.0 (3)	9.802-603.0 (1)	9.802-609.0 (1)
GS3540G.2	8.725-358.0 (1)	8.758-087.0 (1)	8.933-023.0 (3)	9.802-603.0 (1)	9.802-609.0 (1)
GS3540G.3	8.725-358.0 (1)	8.758-087.0 (1)	8.933-023.0 (3)	9.802-603.0 (1)	9.802-609.0 (1)
GS4040G.2	8.725-358.0 (1)	8.758-087.0 (1)	8.933-023.0 (3)	9.802-603.0 (1)	9.802-609.0 (1)
GS4040G.3	8.725-358.0 (1)	8.758-087.0 (1)	8.933-023.0 (3)	9.802-603.0 (1)	9.802-609.0 (1)
GS5030G.2	8.725-358.0 (1)	8.758-087.0 (1)	8.933-023.0 (3)	9.802-603.0 (1)	9.802-609.0 (1)
GS5030G.3	8.725-358.0 (1)	8.758-087.0 (1)	8.933-023.0 (3)	9.802-603.0 (1)	9.802-609.0 (1)
GT4540.2L	8.753-821.0 (1)	8.758-061.0 (1)	8.753-823.0 (3)	8.753-824.0 (1)	9.802-606.0 (1)
GT4540.2R	8.753-821.0 (1)	8.758-061.0 (1)	8.753-823.0 (3)	8.753-824.0 (1)	9.802-606.0 (1)
GT5635.1	8.916-488.0 (1)	8.916-322.0 (3)	9.802-607.0 (3)	9.802-603.0 (1)	9.802-606.0 (1)
GT5636.2L	8.753-821.0 (1)	8.758-061.0 (1)	8.753-823.0 (3)	8.753-824.0 (1)	9.802-606.0 (1)
GT5636.2R	8.753-821.0 (1)	8.758-061.0 (1)	8.753-823.0 (3)	8.753-824.0 (1)	9.802-606.0 (1)
GT6036.2L	8.753-821.0 (1)	8.758-061.0 (1)	8.753-823.0 (3)	8.753-824.0 (1)	9.802-606.0 (1)
GT6036.2R	8.753-821.0 (1)	8.758-061.0 (1)	8.753-823.0 (3)	8.753-824.0 (1)	9.802-606.0 (1)
GX1025.1	8.725-364.0 (1)	8.725-365.0 (3)	9.802-614.0 (3)	9.802-608.0 (1)	9.802-606.0 (1)
GX1036.2L	8.916-487.0(1)	8.757-937.0 (1)	8.752-839.0 (3)	8.753-349.0 (1)	9.802-606.0 (1)
GX1036.2R	8.916-487.0 (1)	8.757-937.0 (1)	8.752-839.0 (3)	8.753-349.0 (1)	9.802-606.0 (1)
GX1225.1	8.725-364.0 (1)	8.725-365.0 (3)	9.802-614.0 (3)	9.802-608.0 (1)	9.802-606.0 (1)
GX1622.2L	8.752-845.0 (1)	8.757-938.0 (1)	8.752-840.0 (3)	8.717-589.0 (1)	9.802-606.0 (1)
GX1622.2R	8.752-845.0 (1)	8.757-937.0 (1)	8.752-840.0 (3)	8.717-589.0 (1)	9.802-606.0 (1)
GX5450L	8.753-512.0 (1)	8.757-939.0 (1)	8.753-514.0 (3)	8.753-515.0 (1)	9.802-606.0 (1)
GX5450R	8.753-512.0 (1)	8.757-939.0 (1)	8.753-514.0 (3)	8.753-515.0 (1)	9.802-606.0 (1)
GX8030.1	8.725-364.0 (1)	8.725-365.0 (3)	9.802-614.0 (3)	9.802-608.0 (1)	9.802-606.0 (1)
GX8043R.2	8.916-488.0 (1)	8.757-936.0 (1)	8.752-838.0 (3)	8.753-349.0 (1)	9.802-606.0 (1)
GX9536.2L	8.916-487.0 (1)	8.757-937.0 (1)	8.752-839.0 (3)	8.753-349.0 (1)	9.802-606.0 (1)
GX9536.2R	8.916-487.0 (1)	8.757-937.0 (1)	8.752-839.0 (3)	8.753-349.0 (1)	9.802-606.0 (1)
HFR105SL	8.754-245.0 (1)	8.754-244.0 (3)	8.754-242.0 (3)	8.754-243.0 (1)	8.754-235.0 (1)
HFR105SR	8.754-245.0 (1)	8.754-244.0 (3)	8.754-242.0 (3)	8.754-243.0 (1)	8.754-235.0 (1)
HFR120SL	8.754-245.0 (1)	8.754-244.0 (3)	8.754-242.0 (3)	8.754-243.0 (1)	8.754-235.0 (1)
HFR120SL	8.754-245.0 (1)	8.754-244.0 (3)	8.754-242.0 (3)	8.754-243.0 (1)	8.754-235.0 (1)
HFR40FL	8.754-231.0 (1)	8.754-232.0 (3)	8.754-233.0 (3)	8.754-243.0 (1)	8.754-235.0 (1)
HFR40FR	8.754-231.0 (1)	8.754-232.0 (3)	8.754-233.0 (3)	8.754-243.0 (1)	8.754-235.0 (1)
HFR40SL	8.754-231.0 (1)	8.754-232.0 (3)	8.754-233.0 (3)	8.754-243.0 (1)	8.754-235.0 (1)
HFR40SR	8.754-231.0 (1)	8.754-232.0 (3)	8.754-233.0 (3)	8.754-243.0 (1)	8.754-235.0 (1)
HFR60FL	8.754-231.0 (1)	8.754-232.0 (3)	8.754-233.0 (3)	8.754-243.0 (1)	8.754-235.0 (1)
HFR60FR	8.754-231.0 (1)	8.754-232.0 (3)	8.754-233.0 (3)	8.754-243.0 (1)	8.754-235.0 (1)
HFR60SL	8.754-231.0 (1)	8.754.232.0 (3)	8.754-233.0 (3)	8.754-243.0 (1)	8.754-235.0 (1)
HFR60SR	8.754-231.0 (1)	8.754-232.0 (3)	8.754-233.0 (3)	8.754-243.0 (1)	8.754-235.0 (1)

**LEGACY HD PUMP REPAIR KIT SELECTION CHART (CONTINUED)**



Use the selection chart below and on the preceding 2 pages to find the correct and quantity repair kits needed for a specific Legacy HD Pump Model.

PUMP MODEL	SEAL KIT (QTY / PUMP)	COMPLETE SEAL KIT (QTY / PUMP)	CERAMIC PLUNGER KIT (QTY / PUMP)	VALVE KIT (QTY / PUMP)	PLUNGER OIL SEAL KIT (QTY / PUMP)
HFR80FL	8.754-231.0 (1)	8.754-232.0 (3)	8.754-233.0 (3)	8.754-234.0 (1)	8.754-235.0 (1)
HFR80FR	8.754-231.0 (1)	8.754-232.0 (3)	8.754-233.0 (3)	8.754-234.0 (1)	8.754-235.0 (1)
HFR80SL	8.754-245.0 (1)	8.754-244.0 (3)	8.754-242.0 (3)	8.754-243.0 (1)	8.754-235.0 (1)
HFR80SR	8.754-245.0 (1)	8.754-244.0 (3)	8.754-242.0 (3)	8.754-243.0 (1)	8.754-235.0 (1)
HHP25SL	8.754-236.0 (1)	8.754-237.0 (3)	8.754-246.0 (1)	8.754-241.0 (1)	8.754-235.0 (1)
HHP25SR	8.754-236.0 (1)	8.754-237.0 (3)	8.754-246.0 (1)	8.754-241.0 (1)	8.754-235.0 (1)
HHP275OR	8.754-236.0 (1)	8.754-240.0 (3)	8.754-246.0 (1)	8.754-247.0 (1)	8.754-235.0 (1)
HHP30SL	8.754-236.0 (1)	8.754-237.0 (3)	8.754-246.0 (1)	8.754-241.0 (1)	8.754-235.0 (1)
HHP30SR	8.754-236.0 (1)	8.754-237.0 (3)	8.754-246.0 (1)	8.754-241.0 (1)	8.754-235.0 (1)
HHP3650L	8.754-236.0 (1)	8.754-240.0 (3)	8.754-246.0 (1)	8.754-247.0 (1)	8.754-235.0 (1)
HHP3650R	8.754-236.0 (1)	8.754-240.0 (3)	8.754-246.0 (1)	8.754-247.0 (1)	8.754-235.0 (1)
HHP38FL	8.754-236.0 (1)	8.754-237.0 (3)	8.754-246.0 (1)	8.755-233.0 (1)	8.754-235.0 (1)
HHP38FR	8.754-236.0 (1)	8.754-237.0 (3)	8.754-246.0 (1)	8.755-233.0 (1)	8.754-235.0 (1)
HHP4150L	8.754-236.0 (1)	8.754-240.0 (3)	8.754-246.0 (1)	8.754-247.0 (1)	8.754-235.0 (1)
HHP4150R	8.754-236.0 (1)	8.754-240.0 (3)	8.754-246.0 (1)	8.754-247.0 (1)	8.754-235.0 (1)
HHP5040L	8.754-236.0 (1)	8.754-240.0 (3)	8.754-246.0 (1)	8.754-247.0 (1)	8.754-235.0 (1)
HHP5040R	8.754-236.0 (1)	8.754-240.0 (3)	8.754-246.0 (1)	8.754-247.0 (1)	8.754-235.0 (1)
HHP5750L	8.754-236.0 (1)	8.754-240.0 (3)	8.754-246.0 (1)	8.754-247.0 (1)	8.754-235.0 (1)
HY1515	8.754-980.0 (1)	8.754-981.0 (3)	8.754-983.0 (1)	8.754-577.0 (1)	9.803-937.0 (1)
HY1520	8.754-980.0 (1)	8.754-981.0 (3)	8.754-983.0 (1)	8.754-577.0 (1)	9.803-937.0 (1)
NMT1520CWR	8.754-252.0 (1)	8.754-253.0 (3)	8.754-248.0 (1)	9.802-603.0 (1)	8.754-261.0 (1)
NMT1520SCWR	8.754-252.0 (1)	8.754-253.0 (3)	8.754-248.0 (1)	9.802-603.0 (1)	8.754-261.0 (1)
NMT2120CWR	8.754-252.0 (1)	8.754-253.0 (3)	8.754-248.0 (1)	9.802-603.0 (1)	8.754-261.0 (1)
NMT2120ESR	8.754-239.0 (1)	8.754-229.0 (3)	8.754-256.0 (1)	8.754-230.0 (6)	8.754-261.0 (1)
NLT2525S	8.916-488.0 (1)	8.755-740.0 (3)	8.752-838.0 (3)	8.753-824.0 (1)	9.802-606.0 (1)

**LEGACY HD PUMP REPAIR - SEAL KITS**



PART NO.	QTY NEEDED PER PUMP	PART NO.	QTY NEEDED PER PUMP
8.725-354.0	1	8.754-236.0	1
8.725-356.0	1	8.754-239.0	1
8.725-358.0	1	8.754-245.0	1
8.725-360.0	1	8.754-252.0	1
8.725-362.0	1	8.754-856.0	1
8.725-364.0	1	8.754-860.0	1
8.752-843.0	1	8.754-980.0	1
8.916-487.0	1	8.759-015.0	1
8.752-845.0	1	8.759-031.0	1
8.753-512.0	1	8.916-488.0	1
8.753-821.0	1	9.804-492.0	1
8.754-231.0	1		

**LEGACY HD PUMP REPAIR - COMPLETE KITS**

FOR 

PART NO.	QTY NEEDED PER PUMP
8.725-355.0	3
8.725-357.0	3
8.725-365.0	3
8.758-061.0	1
8.754.232.0	3
8.754-229.0	3
8.754-237.0	3
8.754-240.0	3
8.754-244.0	3
8.754-253.0	3
8.754-575.0	3
8.754-981.0	3
8.755-740.0	3
8.757-936.0	1

PART NO.	QTY NEEDED PER PUMP
8.757-937.0	1
8.757-938.0	1
8.757-939.0	1
8.758-061.0	1
8.758-081.0	1
8.758-083.0	1
8.758-085.0	1
8.758-086.0	1
8.758-087.0	1
8.758-218.0	1
8.916-322.0	3
8.929-348.0	1
9.804-493.0	3

**LEGACY HD PUMP REPAIR - CERAMIC PLUNGER KITS**

FOR 

PART NO.	QTY NEEDED PER PUMP
8.751-237.0	3
8.751-238.0	3
8.752-838.0	3
8.752-839.0	3
8.752-840.0	3
8.753-514.0	3
8.753-823.0	3
8.754-233.0	3
8.754-242.0	3
8.754-246.0	1
8.754-248.0	1
8.754-256.0	1

PART NO.	QTY NEEDED PER PUMP
8.754-576.0	3
8.754-858.0	3
8.754-862.0	3
8.754-983.0	3
8.933-023.0	3
9.802-607.0	3
9.802-614.0	3
9.802-620.0	3
9.802-629.0	3
9.803-934.0	3
9.803-935.0	3

**LEGACY HD PUMP REPAIR - VALVE KITS**

FOR 

PART NO.	QTY NEEDED PER PUMP
8.717-589.0	1
8.753-349.0	1
8.753-515.0	1
8.753-824.0	1
8.754-230.0	6
8.758-229.0	1
8.754-241.0	1
8.754-243.0	1

PART NO.	QTY NEEDED PER PUMP
8.758-23.0	1
8.754-577.0	6
8.754-859.0	1
9.802-603.0	1
9.802-604.0	1
9.802-608.0	1
9.803-936.0	1

**LEGACY HD PUMP REPAIR - PLUNGER OIL SEAL KITS**

FOR **Legacy<sup>HD</sup>**

PART NO.	QTY NEEDED PER PUMP
8.752-835.0	1
9.802-606.0	1
8.754-235.0	1
8.754-261.0	1

PART NO.	QTY NEEDED PER PUMP
8.754-578.0	1
9.802-606.0	1
9.802-609.0	1
9.803-937.0	1

**INTERPUMP / GENERAL PUMP - SOLID-SHAFT PUMPS**



8.702-629.0



8.702-635.0



8.702-703.0

PART NO.	MODEL NO.	INTERPUMP MODEL NO.	GP MODEL NO.	GPM	PSI	RPM	SHAFT DIA
8.753-482.0			TSS1021	5.6	1700	1450	24 mm
8.753-483.0			TSS1511	4.0	3500	1450	24 mm
8.702-629.0	102048	WS92	TS921	5.9	1800	1450	24 mm
9.802-358.0	102052	W99	T991	3.5	1500	1450	24 mm
8.702-625.0	102046	W92	T921	5.0	1700	1050	24 mm
8.702-622.0	102042	WS82	TS821	5.6	1500	1450	24 mm
8.702-636.0	102058	WS101	TS1011	4.0	2000	1450	24 mm
8.702-635.0	102056	W101	T1011	4.5	2000	1125	24 mm
8.702-646.0	102076	WS133	TS1331	3.5	2100	1450	24 mm
8.702-645.0	102074	WS132	TS1321	4.75	2100	1450	24 mm
8.702-643.0	102072	W132	T1321	5.5	2100	1150	24 mm
8.702-650.0	102084	WS151		4.0	3500	1450	24 mm
8.702-649.0	102082	W151	T1511	4.5	2500	1125	24 mm
8.702-654.0	102088	W162	T1621	5.0	2500	1050	24 mm
8.702-665.0	102105	W201	T2011	4.5	3000	1125	24 mm
8.702-667.0	102110	WS201	TS2011	4.0	3000	1450	24 mm
8.702-670.0	102115G	WS202	TS2021	4.5	3500	1125	24 mm
8.702-701.0	102170	W995	T9951	3.4	1300	1750	24 mm
8.702-702.0	102174	W996	T9961	4.0	1100	1750	24 mm
8.702-703.0	102176	W997	T9971	4.0	2000	1750	24 mm
8.702-686.0	102135	W912	T9121	4.75	1500	1750	24 mm
8.702-687.0	102140	W913	T9131	4.0	1900	1750	24 mm
8.702-690.0	102150	W921	T9211	4.0	2900	1750	24 mm
8.702-693.0	102152	W928	T9281	4.0	4000	1750	24 mm
8.702-695.0	102154	T5050	T5050	5.0	5000	1845	24 mm
8.702-661.0	102097	-	TT9111	3.0	1500	1750	24 mm
8.702-630.0	102049	WW93	TT931	2.9	1500	2800	24 mm
8.702-628.0	102047	WW94	TT941	3.43	1300	2800	24 mm
8.702-685.0	102134	WW935	TT9351	3.5	2500	3400	24 mm
8.702-663.0	102102	WW944	TT9441	4.4	2500	3400	24 mm

\*Duplex Pump

Specifications, product descriptions, product availability, and pricing subject to change without notice.

**INTERPUMP / GENERAL PUMP - TX SOLID-SHAFT PUMP**



PART NO.	MODEL NO.	GPM	PSI	RPM	SHAFT DIA
8.702-741.0	TX1510S34	4.0	3000	3400	24 mm

**INTERPUMP / GENERAL PUMP - SERIES "44" (EZ SERIES) SOLID-SHAFT PUMP**



PART NO.	INTERPUMP MODEL NO.	GP MODEL NO.	GPM	PSI	RPM	SHAFT DIA
8.702-766.0	W956	EZ2536S	3.6	2500	1750	24 mm
8.702-768.0	W959	EZ2542S	4.2	2500	1750	24 mm
8.702-773.0	W186	EZ3040S	4.0	3000	3400	24 mm
8.702-782.0	-	EZ4040S34	4.0	4000	3400	24 mm

Note: For Direct-Drive Mounting see flanges on page 236

**INTERPUMP / GENERAL PUMP - TSF SOLID-SHAFT PUMP**



PART NO.	MODEL NO.	GPM	PSI	RPM	SHAFT DIA
8.702-740.0	TSF2021	7.0	3600	1450	24 mm
8.702-736.0	TSF2221	10.2	3000	1750	24 mm
8.702-737.0	TSF2421	12.0	2500	1750	24 mm
8.702-790.0	TSF2219	7.7	3000	1450	24 mm

**INTERPUMP / GENERAL PUMP - LARGE FRAME SOLID-SHAFT PUMP**



PART NO.	INTERPUMP MODEL NO.	GP MODEL NO.	GPM	PSI	RPM	SHAFT DIA
8.702-612.0	W4A	T41A	12.0	900	650	35 mm
8.702-640.0	WS104	TS1041	8.0	1600	1450	35 mm
8.702-652.0	WS153	TS1531	8.0	2175	1450	35 mm

**INTERPUMP / GENERAL PUMP - CAR WASH SOLID-SHAFT PUMP**



PART NO.	MODEL NO.	GPM	PSI	RPM	SHAFT DIA	SHIP WT
8.702-754.0	CW2040	5.0	2500	1250	24 mm	30 lbs.
8.702-745.0	CW3040	5.0	3000	1250	24 mm	32 lbs.
9.107-630.0	HTCK3623S	21.0	1500	1150	30 mm	80 lbs.



**INTERPUMP / GENERAL PUMP - HOLLOW-SHAFT**



- Direct Drive



8.702-711.0



8.702-708.0

- Flanged for direct couple to gasoline or electric motors

PART NO.	INTERPUMP MODEL NO.	GP MODEL NO.	GPM	PSI	RPM	SHAFT DIA
<b>COUPLE TO GASOLINE MOTORS</b>						
8.702-711.0	WW906G	TT9061G	2.1	1400	3400	3/4"
8.702-682.0		TT1540GBF	4.0	1500	3400	3/4"
8.702-673.0		TT2028GBF	2.8	2000	3400	3/4"
8.702-674.0		TT2035GBF	3.5	2000	3400	3/4"
<b>COUPLE TO ELECTRIC MOTORS</b>						
8.702-708.0	W905E	T9051E	2.1	1400	1750	5/8"
8.702-710.0	WW906E	TT9061E	2.1	1400	3400	5/8"
8.702-713.0	WW907E	TT9071E	2.8	1500	3400	5/8"
8.702-677.0	-	TT9111EBF	3.0	1500	1750	5/8"
8.702-679.0	-	TT2021EBF	2.1	2000	3400	5/8"
8.702-680.0	-	TT2028EBF	2.8	2000	3400	5/8"
8.702-681.0	-	TT2035EBF	3.5	2000	3400	3/4"

**INTERPUMP / GENERAL PUMP - EZ SERIES HOLLOW-SHAFT**



- Direct Drive



- Flanged for direct couple to gasoline or electric motors

PART NO.	INTERPUMP MODEL NO.	GP MODEL NO.	GPM	PSI	RPM	SHAFT DIA
<b>COUPLE TO GASOLINE MOTORS</b>						
8.702-764.0	WW961EZG	EZ3040G	4.0	2500	3400	1"
8.702-776.0	-	EZ4030G34	3.0	4000	3400	1"
8.702-778.0	-	EZ4035G34	3.5	4000	3400	1"
8.702-779.0	-	EZ4040G34	4.0	4000	3400	1"
<b>COUPLE TO ELECTRIC MOTORS</b>						
8.702-758.0	W956EZE	EZ2536E	3.6	2500	1750	1-1/8"
8.702-759.0	W959EZE	EZ2542E	4.2	2500	1750	1-1/8"
8.702-761.0	W950EZE	EZ2545E	2.5	2500	1750	1-1/8"
8.702-760.0	W953EZE	EZ2555E	5.5	2500	3400	1-1/8"
8.702-780.0	-	EZ4035E	3.5	4000	3400	1-1/8"

**INTERPUMP / GENERAL PUMP - TX SERIES HOLLOW-SHAFT**



- Direct Drive



- Flanged for direct couple to 184TC electric motor

PART NO.	MODEL NO.	GPM	PSI	RPM	SHAFT DIA	SHIP WT
8.702-784.0	TX1810E179	3.2	2000	1750	1-1/8"	30 lbs.
8.702-785.0	TX1812E179	3.8	2000	1750	1-1/8"	32 lbs.

**INTERPUMP / GENERAL PUMP KIT SELECTION CHART**

Use the selection chart below to find the correct repair kit for the specific Interpump / General Pump model.



PUMP MODEL	VALVES	OIL SEAL PISTON	PACKINGS	PACKINGS WITH BRASS	CERAMIC	VALVE CAPS	PISTON	BOLTS HEAD RINGS	CRANK OIL SEAL
<b>TX1510S34</b>	Kit 123	Kit 159	Kit 160	Kit 166	52040009	Kit 124	52040009	-	-
<b>TX1810E179</b>	Kit 123	Kit 159	Kit 161	Kit 167	44040109	Kit 124	52040009	-	-
<b>TX1812E179</b>	Kit 123	Kit 159	Kit 161	Kit 167	44040109	Kit 124	52040009	-	-
<b>TSF2021</b>	Kit 169	Kit 2	Kit 170	Kit 171	66040009	66130041	66040109	-	Kit 3
<b>TSF2221</b>	Kit 169	Kit 2	Kit 172	Kit 173	66040109	66130041	66040109	-	Kit 3
<b>TSF2421</b>	Kit 169	Kit 2	Kit 181	Kit 182	66040409	66130041	66040409	-	Kit 3
<b>T9721</b>	Kit 1	Kit 23	Kit 19	Kit 27	50040409	Kit 4	Kit 6	Kit 21	104641
<b>T9731</b>	Kit 1	Kit 23	Kit 19	Kit 27	50040409	Kit 4	Kit 6	Kit 21	104637
<b>T731</b>	Kit 1	Kit 23	Kit 19	Kit 27	50040409	Kit 4	Kit 6	Kit 21	104641
<b>T991</b>	Kit 1	Kit 23	Kit 19	Kit 27	50040409	Kit 4	Kit 6	Kit 21	104641
<b>T9951</b>	Kit 1	Kit 23	Kit 19	Kit 27	50040409	Kit 4	Kit 6	Kit 21	104641
<b>T9971</b>	Kit 1	Kit 23	Kit 19	Kit 27	50040409	Kit 4	Kit 6	Kit 21	104641
<b>T921</b>	Kit 1	Kit 2	Kit 148	Kit 29	47040509	Kit 4	Kit 6	Kit 11	Kit 3
<b>T1011</b>	Kit 1	Kit 2	Kit 69	Kit 28	47040409	Kit 4	Kit 6	Kit 7	Kit 3
<b>T1321</b>	Kit 1	Kit 2	Kit 148	Kit 29	47040509	Kit 4	Kit 6	Kit 11	Kit 3
<b>T9211</b>	Kit 1	Kit 2	Kit 69	Kit 28	47040409	Kit 4	Kit 6	Kit 7	Kit 3
<b>T9281</b>	Kit 1	Kit 2	Kit 109	Kit 112	47040856	Kit 106	Kit 107	Kit 108	Kit 3
<b>T4251</b>	Kit 122	Kit 44	Kit 77	Kit 78	61040056	Kit 122	-	Kit 7	Kit 32
<b>T5050</b>	Kit 150	Kit 2	Kit 109	Kit 151	47040856	Kit 150	47040856	Kit 108	Kit 3
<b>TS1021</b>	Kit 1	Kit 2	Kit 69	Kit 28	47040409	Kit 4	Kit 6	Kit 7	Kit 3
<b>TS1011</b>	Kit 1	Kit 2	Kit 69	Kit 28	47040856	Kit 4	Kit 6	Kit 7	Kit 3
<b>TS1041</b>	Kit 62	Kit 37	Kit 69	Kit 82	47040409	98231200	Kit 54	Kit 7	Kit 32
<b>TS1321</b>	Kit 1	Kit 2	Kit 148	Kit 29	47040509	Kit 4	Kit 6	Kit 11	Kit 3
<b>TS1511</b>	Kit 1	Kit 2	Kit 69	Kit 28	47040409	Kit 4	Kit 6	Kit 7	Kit 3
<b>TS1531</b>	Kit 62	Kit 37	Kit 69	Kit 82	47040409	98231200	Kit 54	Kit 7	Kit 32
<b>TS2011</b>	Kit 1	Kit 2	Kit 69	Kit 28	47040409	Kit 5	Kit 6	Kit 7	Kit 3
<b>TS2021</b>	Kit 1	Kit 2	Kit 69	Kit 28	47040409	Kit 5	Kit 6	Kit 7	Kit 3
<b>TT9111</b>	Kit 1	Kit 83	Kit 141	Kit 140	51040109	Kit 84	51040109	-	104641
<b>TT941</b>	Kit 1	Kit 83	Kit 97	Kit 96	51040009	Kit 84	51040109	-	104641
<b>TT9441</b>	Kit 1	Kit 23	Kit 88	Kit 92	52040009	Kit 4	Kit 6	-	104641
<b>TT2028</b>	Kit 1	Kit 83	Kit 97	Kit 96	051040009	Kit 84	-	-	104637
<b>TT2035</b>	Kit 1	Kit 83	Kit 97	Kit 96	51040009	Kit 84	-	-	104637
<b>TT9061</b>	Kit 1	Kit 83	Kit 97	Kit 96	51040009	Kit 84	-	-	104637
<b>TT9071</b>	Kit 1	Kit 83	Kit 97	Kit 96	51040009	Kit 84	-	-	104637
<b>EZ2542E</b>	Kit 123	Kit 23	Kit 127	Kit 131	44040109	Kit 124	-	Kit 129	104649
<b>EZ2545E</b>	Kit 123	Kit 23	Kit 88	Kit 130	52040009	Kit 124	-	Kit 90	104649
<b>EZ3035G</b>	Kit 123	Kit 23	Kit 88	Kit 130	52040009	Kit 124	52040009	Kit 90	104649
<b>EZ3040G</b>	Kit 123	Kit 23	Kit 88	Kit 130	52040009	Kit 124	52040009	Kit 90	104649
<b>EZ3040S</b>	Kit 123	Kit 23	Kit 88	Kit 130	52040009	Kit 124	52040009	Kit 90	104644
<b>T9051EBF</b>	Kit 1	Kit 83	Kit 97	Kit 96	52040009	Kit 84	51040009	-	104644
<b>EZ2542S</b>	Kit 123	Kit 23	Kit 127	Kit 131	44040109	Kit 124	44040109	Kit 129	104644
<b>EZ3042S</b>	Kit 123	Kit 23	Kit 127	Kit 131	44040109	Kit 124	44040109	Kit 129	104644
<b>ES4040S34</b>	Kit 123	Kit 23	Kit 153	Kit 156	44040266	Kit 124	44040266	Kit 155	104644
<b>EZ3030G34</b>	Kit 123	Kit 23	Kit 88	Kit 130	52040009	Kit 124	52040009	Kit 90	104649
<b>EZ3045G</b>	Kit 123	Kit 23	Kit 88	Kit 130	52040009	Kit 124	52040009	Kit 90	104649
<b>EZ4035G34</b>	Kit 123	Kit 23	Kit 153	Kit 156	44040266	Kit 124	44040266	Kit 155	104649
<b>TS1331-B</b>	Kit 1	Kit 2	Kit 69	Kit 28	47040409	Kit 4	Kit 6	Kit 7	Kit 3
<b>T1631</b>	Kit 1	Kit 24	Kit 148	Kit 29	47040509	Kit 4	Kit 6	Kit 11	-
<b>CW1012</b>	Kit 62	Kit 37	Kit 113	Kit 67	69040109	-	Kit 74	Kit 65	Kit 32

**INTERPUMP / GENERAL PUMP KITS - GENUINE**

We stock a complete selection of original Interpump / General Pump repair kits. See previous page for our kit selection chart.



- Complete selection of repair kits

PART NO.	KIT.	DESCRIPTION
8.702-798.0	1	Valve
8.702-800.0	2	Piston, Rod Oil Seal
8.702-801.0	3	Crankshaft Oil Seal
8.702-802.0	4	Valve Cap
8.702-803.0	5	Valve Cap
8.702-805.0	6	Piston Bolt
8.702-804.0	6A	Washer for Piston Bolts
8.702-806.0	7	Head Ring
8.702-116.0	8	HP Old Style, 20 mm Packing
8.702-115.0	8	New Style
8.900-442.0	8	Old Style, Packing Kit
8.900-444.0	9	Packing Spacer
8.702-809.0	10	Retainer, 20 mm Packing
8.702-810.0	11	22 mm Head Ring
8.702-811.0	12	22 mm Packing
8.702-813.0	15	Packing Adapter
8.702-814.0	16	24 mm Packing
8.702-817.0	19	20 mm HP Packing
8.702-818.0	19	New Style
8.702-820.0	20	20 mm, Intermed. Ring
8.702-821.0	21	20 mm Head Ring
8.702-823.0	23	Piston, Rod Oil Seal
8.702-824.0	24	Piston, Rod Oil Seal
8.702-826.0	27	20 mm, Packing Assy
8.702-829.0	28	20 mm, Packing Assy
8.702-830.0	29	22 mm, Packing Assy
8.702-833.0	32	Crankshaft, Oil Seal
8.702-834.0	37	Piston, Rod Oil Seal
8.702-836.0	38	36 mm Packing
8.702-847.0	58	K5 Maintenance
8.702-849.0	60	K5, Complete Rebuild
8.702-851.0	62	Valve
8.702-853.0	64	Packing w/ Intermed. Rings
8.702-854.0	65	30 mm, Head Ring
8.702-857.0	69	20 mm Packing with Restop
8.702-858.0	70	K7 Maintenance
8.702-859.0	71	Intermed Ring with Restop
8.702-860.0	72	Maintenance Kit
8.702-864.0	77	20 mm Packing with Restop
8.702-872.0	83	Oil Seal
8.702-873.0	84	Valve Cap
8.702-874.0	85	Complete Packing
8.702-875.0	86	Packing Retainer
8.702-877.0	88	Packing, EZ3040G

PART NO.	KIT.	DESCRIPTION
8.702-879.0	90	Head Ring
8.702-882.0	92	Piston Seal
8.702-883.0	93	Control Set W2
8.702-886.0	96	Packing Assy
8.702-887.0	97	Packing
8.702-893.0	102	Unloader Maintenance
8.702-897.0	106	Valve Cap
8.702-898.0	107	Piston Bolt, Pump T9281
8.702-899.0	108	Head Ring for T-9281
8.702-900.0	109	16 mm, Intermed Ring
8.702-901.0	110	16 mm, Intermed Ring
8.702-902.0	111	Packing, Retainer, 16 mm, Pump T9281
8.702-903.0	112	16 mm, Packing Assy
8.702-904.0	113	Packing Assy
8.702-908.0	118	Packing
8.702-909.0	119	Packing
8.702-912.0	122	Valves
8.702-913.0	123	Valve, EZ3040
8.702-914.0	124	Valve Cap and O-Ring for EZ Pump
8.702-917.0	127	Packing, EZ2542S
8.702-919.0	129	Head Ring, EZ Series
8.702-920.0	130	Packing Complete
8.702-921.0	131	EZ Pump
8.702-928.0	140	Packing Assy, T9111
8.702-929.0	141	Packing Assy
8.702-930.0	148	22 mm Packing
8.702-932.0	150	Valve, General T5050
8.702-933.0	151	Packing Retainer
8.702-934.0	153	Packing Kit
8.702-936.0	156	13 mm Packing
8.702-937.0	159	Oil Seal
8.702-938.0	160	Short Packing
8.702-939.0	161	Packings
9.841-673.0	163	Seal Retainer
9.841-638.0	165	Int Ring
8.702-942.0	166	Long Kit 1
8.702-943.0	167	Packing Assy
8.702-945.0	169	Valve Kit
8.702-946.0	170	LP Seal Kit and HP Seal
8.702-947.0	171	Packings
8.702-948.0	172	Low / High Packing
8.702-949.0	173	Packings, Kit 176 & Kit 180
8.702-950.0	174	Seal Kit

**INTERPUMP / GENERAL PUMP KITS - GENUINE (CONTINUED)**



PART NO.	KIT.	DESCRIPTION
8.702-951.0	175	16MM Seal Kit
8.702-952.0	176	18 mm Packing
8.702-953.0	180	18 mm Packing
8.702-954.0	181	LP Seal Kit and HP Seal
8.702-955.0	182	Packings, Kit 196 & Kit 197
8.702-956.0	196	15 mm HP Packing
8.702-957.0	197	18 mm HP Packing
8.702-958.0	201	Valve kit
8.702-959.0	202	Packing Kit
8.723-898.0	203	Seals

PART NO.	KIT.	DESCRIPTION
8.702-960.0	204	Seals
8.723-512.0	212	Kit 212
8.702-962.0	226	15 mm Packing
8.702-961.0	220	Hot Seals & Valves
9.105-490.0	269	Kit 269
9.105-449.0	277	18 MM Packing
9.105-450.0	271	Seals
8.756-374.0	290	20 mm Packing
9.107-628.0	967	30 mm Packing Assy

**CERAMIC PLUNGERS**



- Precision-ground, high-polish, solid ceramic plungers, designed for long life even under constant use.

PART NO.	GENERAL PUMP PART NO.	SIZE
8.703-185.0	51040109	18 mm
8.703-187.0	52040009	15 mm, EZ Series
8.703-188.0	46040009	For W50 Pump
8.703-190.0	47040409	20 mm
8.703-191.0	44040109	18 mm, EZ Series
8.703-192.0	47040509	22 mm
8.900-575.0	51040166	18 mm, TP Series
8.703-193.0	47040609	24 mm Solid, Ceramic
8.703-194.0	47040856	16 mm, 47 Series
8.703-195.0	50040409	20 mm, T Series 49
8.703-196.0	61040056	20 mm, 76 & 77 Series
8.703-198.0	44040266	13 mm, EZ Series
8.703-200.0	76040209	45 mm
8.703-767.0	66040109	22 mm, TSF2221
8.703-768.0	66040409	24 mm
8.701-400.0	51040009	15 mm, T21
9.106-229.0	59040009	20 mm



## AR TRIPLEX CERAMIC PLUNGER PUMPS

■ Direct Drive



8.702-498.0



8.702-513.0



8.702-550.0

PART NO.	MODEL NO.	GPM	PSI	RPM	SHAFT DIA	SHIP WT
<b>GAS ENGINE FLANGED MODELS</b>						
8.702-494.0	XTV3G22D-F7	3.0	2200	3400	3/4"	11 lbs.
8.702-498.0	XMV3G30D-F24	3.0	3000	3400	1"	19 lbs.
8.702-495.0	XMV3G25D-F25	3.0	2500	3400	3/4"	19 lbs.
8.702-542.0	XMV35G25D-F25	3.5	2500	3400	3/4"	19 lbs.
8.702-602.0	RKV4G37D-F24	4.0	3700	3400	1"	21 lbs.
8.702-582.0	RKV4G40HD-F24	4.0	4000	3400	1"	21 lbs.
9.108-219.0	RMV2.5G30	2.5	3000	3400	3.4"	7.5 lbs.
<b>SOLID-SHAFT MODELS</b>						
8.702-506.0	XTA3G22N	3.0	2200	1750	24 mm	11 lbs.
8.715-307.0	XMA3.5G25N	3.5	2500	1750	24 mm	18 lbs.
8.702-593.0	RKA4G30N	4.0	3000	1750	24 mm	19 lbs.
8.702-597.0	RKA4G40HN	4.0	4000	1750	24 mm	21 lbs.
8.702-513.0	XW2623	6.87	3400	1450	24 mm	34 lbs.
<b>ELECTRIC FLANGED MODELS</b>						
8.702-550.0	XTV2G15EBA-F8	2.1	1500	3400	5/8"	10 lbs.
8.702-551.0	XTV3G16E-F8	3.0	1600	3400	5/8"	10 lbs.
8.702-500.0	XTV3G22E-F8	3.0	2200	3400	5/8"	11 lbs.
8.702-515.0	XTA3G22E-F8	3.0	2200	1750	5/8"	11 lbs.
8.702-514.0	XTA3G16EBA-F8	3.0	1600	1750	5/8"	10 lbs.
8.702-591.0	RKA4G20E-F17	4.0	2000	1750	1-1/8"	21 lbs.
8.702-592.0	RKA4G30E-F17	4.0	3000	1750	1-1/8"	21 lbs.

**AR DIRECT DRIVE PUMPS**



**9.113-119.0**



**9.113-106.0**



**9.113-103.0**

PART NO.	MODEL NO.	GPM	PSI	RPM	SHAFT DIA	SHIP WT
<b>DIRECT DRIVE GAS PUMPS</b>						
9.113-101.0	RCV3G27D-F7	3.0	2700	3400	3/4"	11 lbs.
9.113-102.0	RCVU3G27D-F7-EZ	3.0	2700	3400	3/4"	11 lbs.
9.113-116.0	RCV25G27D-F7	2.5	2700	3400	3/4"	11 lbs.
9.113-118.0	RCV35G25D-F8	5.0	2500	3400	5/8"	11 lbs.
9.113-119.0	RCV3G27D-VR54-PKG	3.0	2700	3400	1"	11 lbs.
9.113-121.0	RKV35G40HD-F24	3.5	4000	3400	1"	21 lbs.
9.113-122.0	RKV45G40HD-F24	4.5	4000	3400	1"	21 lbs.
9.113-123.0	RKV5G40HD-F24	5.0	4000	3400	1"	21 lbs.
<b>DIRECT DRIVE ELECTRIC PUMPS</b>						
9.113-106.0	RK1828HN	4.75	4000	1450	24 mm	20 lbs.
9.113-111.0	RCA2G22E-F8	2.0	2200	1750	5/8"	11 lbs.
9.113-112.0	RCA35G16E-F8	3.5	1600	1750	5/8"	11 lbs.
9.113-114.0	RCA3G25E-F8	3.0	2500	1750	24 mm	11 lbs.
9.113-117.0	RCV2G25E-F8	2.0	2500	3400	5/8"	11 lbs.
9.113-124.0	RRA35G30E-F17	3.5	3000	1750	1-1/8"	18 lbs.
9.113-125.0	RRA3G30E-F17	3.0	1700	1750	1-1/8"	18 lbs.
<b>COMMERICAL PUMPS</b>						
9.113-103.0	RG1528HN	4.0	4000	1450	24 mm	27.5 lbs.
9.113-104.0	RG2125HN	5.5	3650	1450	24 mm	27.5 lbs.
9.113-105.0	RK1528HN	4.0	4000	1450	24 mm	20 lbs.
9.113-107.0	RKA4G40HN-CR	4.0	4000	1750	24 mm	20 lbs.
9.113-108.0	RRA55G26E-F17	5.5	3000	1750	1-1/8"	18 lbs.
9.113-109.0	RRV4G40-VRT-PKG	4.0	3600	3400	1"	20 lbs.
9.113-110.0	XWL50.20NB	13.0	3000	1450	22 mm	34 lbs.
9.113-113.0	RCA35G25N	3.5	2500	1750	24 mm	10 lbs.
9.113-115.0	RCA3G25N	3.0	2500	1750	24 mm	10 lbs.
9.113-120.0	RKA35G40HN	3.5	4000	1750	24 mm	20 lbs.
9.113-126.0	RRA4G40N	4.0	4000	1750	24 mm	17 lbs.
9.113-127.0	RRA55G30N	5.5	3000	1750	24 mm	17 lbs.
9.113-129.0	RRV35G40HD-F24	3.5	4000	3400	1"	18 lbs.
9.113-130.0	RRV3G36D-F24	3.0	3600	3400	1"	18 lbs.

## AR PUMP REPAIR KIT SELECTION CHART

Use the following chart to find AR Repair Kits by pump model number. See next page for AR kit part numbers. We also stock a broad selection of non-kit AR repair parts.



PUMP MODEL	WATER SEALS	CHECK VALVES	OIL SEALS	PISTON KIT	PISTON GUIDE	SUPPORT RINGS	HOT KIT
<b>XJV</b>	AR002798	AR002869	AR002797	AR002596	AR1980180 ea	AR1980190 ea	-
<b>XJW</b>	AR002800	AR002869	AR002797	AR002596	AR1980180 ea	AR1980190 ea	-
<b>XT-15MM</b>	AR001866	AR001864	AR001872-N ver AR002725-H/D	AR002628	AR1260151 ea	AR1520120 ea	AR002815
<b>XT-18MM</b>	AR001874	AR001864	AR001872-N ver AR002726-H/D	AR002629	AR1260450 ea	AR1320340 ea	AR002816
<b>XTA-15MM</b>	AR001866	AR001864	AR001860-E ver	AR002628	AR1260151 ea	AR1520120 ea	AR002815
<b>XTA-18MM</b>	AR001874	AR001864	AR001860-E ver	AR002629	AR1260450 ea	AR1320340 ea	AR002816
<b>XTV</b>	AR002520	AR001864	AR001860-D, E ver AR001872-N ver	AR002628	AR1260151 ea	AR1520120 ea	AR002815
<b>XM-15MM</b>	AR002741	AR001864	AR002786-N ver AR1780100 ea R	AR002544	AR1780090 ea F	AR002740	AR002030-V
<b>XM-18MM</b>	AR002747	AR001864	AR002786-N ver AR1780120 ea R	AR002545	AR1780110 ea F	AR002745	AR002029-V
<b>XMA-15MM</b>	AR002741	AR001864	AR002786-N ver AR1780100 ea R	AR002544	AR1780090 ea F	AR002740	AR02776
<b>XMA-18MM</b>	AR002747	AR001864 AR002787-E ver	AR002786-N ver AR1780120 ea R	AR002545	AR1780110 ea F	AR002745	AR002777
<b>XMV</b>	AR002741	AR001864 AR002787-D ver	AR002786-N ver AR1780100 ea R	AR002544	AR1780090 ea F	AR002740	AR02817
<b>XRC-18MM</b>	AR001857	AR002864	AR001855-N ver	AR002546	AR1380090 ea	AR001829	AR002819
<b>XRC-20MM</b>	AR001887	AR002864	AR001855-N ver	AR002547	AR1380150 ea	AR001815	AR002820
<b>XRCA-18MM</b>	AR001857	AR002864	AR001855-N ver	AR002546	AR1380090 ea	AR001829	AR002819
<b>XRCA-20MM</b>	AR001887	AR002864	AR001855-N ver AR001856-E ver	AR002547	AR1380150 ea	AR001815	AR002820
<b>XRCV</b>	AR001857	AR001828	AR001856-D, E ver	AR002546	AR1380090 ea	AR001829	AR002819
<b>RK-18MM</b>	AR001857	AR002864	AR001855-N ver	AR002547	AR1380090 ea	AR001829	AR0042213
<b>RK-20MM</b>	AR001887	AR002864	AR001855-N ver	AR002546	AR1380150 ea	AR001815	AR002820
<b>RKA-18MM</b>	AR001857	AR002864	AR001855-N	AR002546	AR1380090 ea	AR001829	AR0042213
<b>RKA-20MM</b>	AR001887	AR002864	AR001855-N ver	AR002547	AR1380090 ea	AR001515	AR002820
<b>RKV</b>	AR001857	AR001828	AR001856	AR002546	AR1380150 ea	AR001829	AR0042213
<b>XW-20MM</b>	AR002782	AR002780	AR002781	AR002542	AR2784 ea	-	AR002778
<b>XW-22MM</b>	AR002783	AR002780	AR002781	AR002543	AR002785	-	AR002779
<b>XWA-20MM</b>	AR002782	AR002780	AR002781	AR002542	AR002784	-	AR002778
<b>XWA-22MM</b>	AR002783	AR002780	AR002781	AR002543	AR002785	-	AR002779
<b>SXW-18MM</b>	AR002874	AR002871	AR002873	AR002548	AR002875	-	-

**AR PUMP KITS**

Original factory-direct repair kits. See previous page for kit selection chart. Don't see what you're looking for? Give us a call. We stock a broad selection of AR replacement parts. AR piston kits contain all that you need to repair broken pistons, O-rings, washers, nuts, plungers...YOU GET IT ALL!



PART NO.	MODEL NO.	KIT DESCRIPTION
8.720-573.0	AR001804	Packing
8.720-574.0	AR001805	Packing, 20 mm
8.740-118.0	AR001806	Pump
8.720-575.0	AR001815	Piston
8.720-578.0	AR001825	Valve Kit
8.720-579.0	AR001826	Piston Bolt
8.720-581.0	AR001828	Valve
8.720-582.0	AR001829	Ring, Support, XRA / XRV*
8.720-583.0	AR001830	Repair, AR 2882, O-Rings Only
8.720-585.0	AR001842	Piston, XRA / XRV*
8.720-586.0	AR001843	Piston, XRA, XR
8.720-592.0	AR001855	Oil Seal, XRA*
8.720-593.0	AR001856	Oil Seal, XRV
8.720-594.0	AR001857	Packing, XRA / XRV*
8.720-596.0	AR001860	Seal, Oil, XTV*
8.720-597.0	AR001864	Valve Kit
8.720-598.0	AR001865	Oil Seal
8.720-599.0	AR001866	Water Seals
8.720-601.0	AR001869	Repair Unloader
8.720-602.0	AR001872	Oil Seal
8.720-603.0	AR001873	Oil Seal Kit Complete
8.720-604.0	AR001874	Packing
8.720-606.0	AR001887	Water Seals
8.720-611.0	AR002031	Viton Seal, XRA
8.720-612.0	AR002043	Oil Seal
8.720-613.0	AR002044	Seal
8.720-632.0	AR002544	Piston, XM*
8.720-633.0	AR002546	Piston XRCA / XRCV
8.720-643.0	AR002624	Seal
8.720-644.0	AR002628	AR Piston #2628
8.720-649.0	AR002697	Repair, Combination Set
8.720-651.0	AR002740	Support Ring, XM*
8.720-652.0	AR002741	Water Seal, XM*
8.720-655.0	AR002747	Packing, XMA* 18 mm
8.720-658.0	AR002776	Hot / Dry Cup
8.720-661.0	AR002780	Valve, XWA8G30N-SX
8.720-662.0	AR002781	Seal, XWA8G30N-SX
8.720-663.0	AR002782	Piston Seal, XWA8G30N-SX
8.720-665.0	AR002784	Piston Guide, XWA8G30N-SX
8.720-667.0	AR002786	Oil Seals, XMA35G25N
8.720-668.0	AR002787	Oil Seals
8.720-684.0	AR002864	Valve Kit, RK*
8.702-623.0	AR002278	Hot Pack Kit
9.105-742.0	AR42476	Water Seal Kit -RCV-RCVU
9.105-982.0	AR42638	Complete head with seals and valves

\*Series

Specifications, product descriptions, product availability, and pricing subject to change without notice.



CAT TRIPLEX PUMPS



■ Direct Drive



8.702-444.0



8.702-381.0



8.702-464.0



9.113-051.0



9.113-054.0



9.113-046.0



9.109-786.0



8.702-436.0

PART NO.	MODEL NO.	GPM	PSI	RPM	SHAFT DIA	SHIP WT
<b>SOLID SHAFT MODELS</b>						
8.702-444.0	56	5.5	3500	1210	24 mm	29 lbs.
8.702-440.0	530	5.0	2500	1100	24 mm	26 lbs.
8.702-449.0	660	10.0	3000	1429	30 mm	44 lbs.
9.113-045.0	700	4.7	5000	1750	24 mm	29 lbs.
8.702-429.0	310	4.0	2200	950	20 mm	20 lbs.
8.702-381.0	310S	4.0	2200	950	20 mm	20 lbs.
8.702-464.0	5CP3120	4.5	3500	1750	20 mm	20 lbs.
9.113-051.0	5CP3120CSS	4.5	3500	1645	20 mm	20 lbs.
8.702-465.0	5CP5120	5.0	3000	1415	20 mm	20 lbs.
9.113-052.0	5CP5140CSS	5.5	3500	1500	20 mm	20 lbs.
<b>DIRECT DRIVE ELECTRIC FLANGED MODELS</b>						
9.113-048.0	4DX20ER	2.0	2000	3450	5/8"	11 lbs.
9.113-049.0	4DX27ER	2.7	2000	3450	5/8"	11 lbs.
9.113-053.0	5SP30ELU	3.0	3000	1750	1-1/8"	13.2 lbs.
9.113-054.0	5SP35ELU	3.5	2500	1750	1-1/8"	13.2 lbs.
9.113-055.0	5SP40ELU	4.0	2000	1750	1-1/8"	13.2 lbs.
<b>DIRECT DRIVE GAS FLANGED MODELS</b>						
9.113-046.0	4DNX25GSI	2.5	3000	3450	3/4"	11 lbs.
9.113-047.0	4DNX27GSI	2.7	3000	3450	3/4"	11 lbs.
9.113-050.0	4DX29GUIF	2.9	2600	3450	3/4"	14 lbs.
9.109-786.0	4SPX32G1I	3.2	3000	3450	1"	18 lbs.
9.113-057.0	67DX39G1I	3.9	4000	3450	1"	18 lbs.
8.702-436.0	66DX35G1I	3.5	4000	3400	1"	27 lbs.
8.702-435.0	66DX40G1I	4.0	4000	3400	1"	27 lbs.
9.113-056.0	66DX40GG1	4.0	4000	3400	1"	27 lbs.

**COMET PUMPS AND PUMP KITS**

For use in homeowner or light commercial-duty pressure washers.



- One-Piece Bronze Connection Rods
- Built-in Unloader
- Increased surface area for lower operating temperatures Ultra High-Pressure Head



PART NO.	MODEL NO.	GPM	PSI	RPM	SHAFT DIA	INLET/OUTLET
9.802-357.0	AXD 2020 E	1.9	2000	3400	5/8" Hollow	3/4" FGH/3/8" MPT
8.702-576.0	AXD 3020 G	2.75	2000	3400	3/4" Hollow	3/4" FGH/3/8" MPT
8.715-286.0	AXD 2427 G	2.5	2700	3400	3/4" Hollow	3/4" FGH/3/8" MPT
8.750-238.0	BXD 2020 E	1.9	2000	3400	5/8" Hollow	1/2" FPT/3/8" MPT

Comet kits and parts are available for any Comet model. Call with model number for quick and accurate service.

PART NO.	MODEL NO.
8.721-902.0	Piston, 15 mm, FWD
8.721-903.0	Piston, 18 mm, FWD
8.718-556.0	Seal Kit, LWD, HP
8.721-979.0	Packing Kit, FWS / FWD
8.721-985.0	Seal Kit Oil, LW Series, Hollow
8.721-986.0	Seal Kit, ZWD4030G
8.721-987.0	Seal Kit, Hollow Shaft Pumps
8.721-989.0	Seal Kit, AXD2020
8.721-988.0	Seal Kit, AXD3020
8.750-711.0	Seal Kit, BXD2020 E
8.721-996.0	Valve Kit ZWD / FWS / FWD / HW / FW / LW
8.721-997.0	Valve Kit, AXD 3020
8.725-562.0	Valve Kit, BXD 2020

**Comet Pumps & Pump Kits - MC25-GR (with Gear Reducer)**

Perfect for Soft Wash, Ag Spraying, Lawn Care, Nursery, Pest Control, Mold Removal & Insulation applications.



- Twin Diaphragm, Low Pressure
- DURAphragm Technology
- Features Anodized Aluminum body for corrosion resistance
- Buna Diaphragm/Seals
- 3/4" Hydraulic Drive
- Includes Adjustable Pressure Regulator, manual dump lever & rails

PART NO.	GPM	PSI	RPM	SHAFT DIA	INLET/OUTLET	BYPASS
9.113-711.0	6.1	362	650	3/4"	3/4" / 3/8"	1/2"

## PISTON PUMPS - HYPRO



8.702-156.0

- Temperature Max: 140°F (except 5321)
- Temperature Max: 180°F (for 5321)
- Cast Iron Body
- Stainless-Steel Check Valves
- Complete with Base or Torque Arm
- Buna Cups
- 1/2 NPT Ports

PART NO.	HYPRO	GPM	PSI	RPM
<b>SOLID SHAFT</b>				
8.702-158.0	5320	2.0	500	1750
8.702-161.0	5321	2.2	1000	1750
8.702-167.0	5330	3.0	500	1750
<b>HOLLOW SHAFT</b>				
8.702-156.0	5315	1.5	500	1750
8.702-159.0	5320	2.0	500	1750
8.702-160.0	5321	2.2	1000	1750
8.702-166.0	5330	3.0	500	1750
8.702-146.0	Injector Head 5320 / 5330 Pump			
8.702-152.0	Injector Head 5321 / 5324 Pump			

## PUMP PARTS AND TOOLS



For 5300 Series pumps.

- A necessity for working on 5300 Series pumps
- Rugged Construction



Valve Seat Tools



Piston Repair Kit



Valve Cage Tools

PART NO.	DESCRIPTION
8.722-629.0	Piston Repair Kit, Model 5320 Pump
8.722-634.0	Piston Repair Kit, Model 5321 Pump
8.722-641.0	Check Valve Kit, All 5300 Pumps
8.712-510.0	Valve Cage Tool
8.712-512.0	Valve Seat Tool

Note: Piston Repair Kits have Buna Seal

## PUMP PACKING & SEAL KITS - GENERIC - A+



UPC, General Pump and Interpump replacement kits. Time-tested, quality parts meet or exceed factory specifications.



PART NO.	DESCRIPTION
8.900-438.0	Kit 1, Check Valve
8.900-440.0	Kit 2, Oil Seal
8.900-441.0	Kit 3, Cranshaft Oil Seal
8.900-442.0	Kit 8, New Style Packing Kit
8.900-443.0*	Kit 8, V-Packing
8.900-444.0*	Kit 9, Intermed Packing
8.900-447.0*	Kit 12, V-Packing
8.900-456.0*	Kit 19, V-Packing
8.900-463.0	Kit 23, Crankcase Oil Seal
8.900-464.0	Kit 24, Crankcase Oil Seal
8.900-466.0*	Kit 27, Plunger Repair
8.900-468.0*	Kit 28, Plunger Repair
8.900-471.0*	Kit 29, Plunger Repair
8.900-476.0	Kit 37, Oil Seal
8.900-485.0	Kit 83, Oil Seal
8.900-492.0	Kit 97, Packing

\*These are old style kits to replace components in Interpump / General pumps with two brown Buna-V packings (pumps built before the change was made to restop ring and black low-pressure seals).

## JETTER PULSE VALVES



- Replaces valve cap to create pulsation action, to move nozzle in pipe cleaning applications.

PART NO.	DESCRIPTION
8.755-228.0	For Legacy GB / GF / GP Series
8.755-229.0	For Legacy GM Series / GS Series
8.755-230.0	For Legacy GT Series
8.755-231.0	For Legacy GX Series, 4350 PSI
8.712-249.0	For GP 47 Series Pump
8.712-250.0	For GP TT Pumps

**ACCUMULATOR BY INTERPUMP**

Pulse dampener.

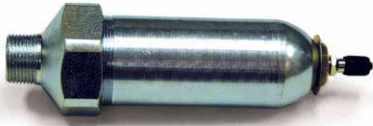

- PSI Max: 1350
- GPM Max: 10
- 3/4" MPT Connector
- Weight: 1 lbs.

PART NO.	MAX PSI	MAX GPM	DESCRIPTION
8.711-148.0	1350	10	Accumulator

**ACCUMULATOR - PULSE DAMPENER**

Pulse dampener.



- Precharge Pressure PSI: 580
- Temperature Max: 180°F

PART NO.	WORKING PSI	CAPACITY	INLET
8.711-145.0	3100	21.4 CU"	1/2" F
8.711-146.0	3100	6.1 CU"	3/8" F
8.711-147.0	4400	2.5 CU"	3/8" F

**INTERPUMP / GENERAL PUMP - V-PACKING INSERTION TOOL KIT**



- Contains inserting tools for installing 20 mm, 22 mm and 24 mm V-packings in the packing gland
- Prevents damage to sealing surfaces

PART NO.	DESCRIPTION
8.712-519.0	V-Packing Kit
9.109-643.0	V-Packing Kit, 15mm and 18mm, 63 Series

**PUMP TOOLS - EXTRACTOR PLIERS & DENTAL PICK**



- Indispensable for Pump Repair
- Excellent for removing O-rings, seals, and more
- 6" Long Dental Pick
- Stainless-Steel
- Knurled Handle
- Double-End

PART NO.	DESCRIPTION
8.707-467.0	Dental Pick
9.802-568.0	Pliers, Seal Extractor

**PUMP PACKING EXTRACTOR HAMMER & SOCKETS**

Virtually unbreakable sockets will pull packings from Interpump, General and other brand pumps.

Easy to use: Slide-Hammer (shown below) attaches to slotted socket - which expands inside the packing gland. The slide hammer then pops the packing gland brass out of the head to facilitate easy seal repairs without damage to brass support rings.

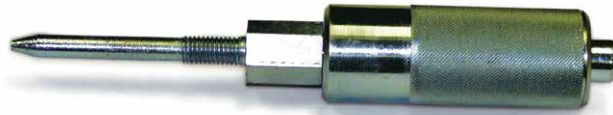

PART NO.	DESCRIPTION
<b>SLIDE HAMMER</b>	
8.712-513.0	Hammer Only
<b>SOCKETS FOR REGULAR SLIDE HAMMER</b>	
8.712-516.0	18 mm Socket
8.712-515.0	15 mm Socket
8.712-517.0	20 mm Socket
8.712-518.0	22 mm Socket
8.712-520.0	25 mm Socket
<b>LARGE SLIDE HAMMER</b>	
8.712-521.0	Large Slide Hammer
<b>SOCKETS FOR LARGE SLIDE HAMMER</b>	
8.712-523.0	30 mm Socket
8.712-524.0	38 mm Socket
8.712-525.0	45 mm Socket

**INTERPUMP PACKING / EXTRACTION TOOL**



Expansion tool inserts into packing gland to remote lodged packing components



PART NO.	DESCRIPTION
8.712-522.0	Extractor Only
<b>EXPANSION SOCKETS FOR EXTRACTOR ABOVE</b>	
8.712-526.0	15 mm, Ref Kit 86 and 97
8.712-528.0	20 mm, Ref Kit 8 and 19
8.712-529.0	22 mm, Ref Kit 12
8.712-530.0	24 mm, Ref Kit 16

Note: 15 mm Expansion Sockets also Fit Admiral Pump W-Series Pumps.

**PUMP OIL**



- Quality mineral base lubricating oil ideal for use in high pressure piston precision plunger pumps.
- Blended with wear, rust and foam inhibitors.
- Available in 10W30 & 10W40

PART NO.	DESCRIPTION
8.923-425.0	Pump Oil 10W40, Quart
8.901-077.0	Pump Oil 10W30, Quart
8.901-080.0	Pump Oil 10W30, Case (12 Quarts)

**GEAR BOX LUBE**



- A premium-quality lubricating oil fortified with additives to reduce friction, foaming and corrosion.
- Ideal for use in heavy industrial applications requiring hydraulic based lubricant.

PART NO.	DESCRIPTION
8.756-854.0	Pump Lube, Quart
9.808-016.0	Case Lot, Qty 12

**PUMP LUBE**



- A multi-viscosity SAE 80W 90 lubricant with anti-friction, anti-foaming and corrosion-inhibitor additives.
- Use in Admiral Geared Speed Reducers and Interpump / General RS99, RS151, PTO and other high-speed gear boxes.

PART NO.	DESCRIPTION
8.756-728.0	Gear Lube, 2-1/2 Gallons

**GP PUMP PACKING / EXTRACTION KIT - COMPLETE**



- 13 mm - 24 mm in a Carrying Case
- Slide Hammer
- 13 mm, 15 mm, 18 mm, 20 mm, 22 mm and 24 mm Sockets
- Fits General Pumps

PART NO.	DESCRIPTION
8.723-619.0	Puller & Packaging Kit

**GEAR REDUCTION**



Fits Legacy, Admiral, Bertolini, GP, Interpump, Comet, Udor & Hawk. Please be sure to check with your representative to ensure the proper gearbox for your pump.



- Engine-to-Pump Drive Units
- 2.18 to 1 Reduction Ratio (3,675 Eng. RPM = 1,750 Pump RPM)
- Engine Shaft Size = .0984", 1", 1-1/8" & 3/4"
- 18-24HP Range, Input Shaft = 1", Output Shaft = 24mm, 87mm Flg. Mout.

PART NO.	DESCRIPTION
8.710-332.0	24 mm Pump x 1-1/8" Engine
8.710-333.0	30 mm Pump x 1" Engine
8.715-344.0	25 mm Pump x 1" Engine, B18
8.715-342.0	24 mm Pump x 1" Engine, B18
8.749-925.0	24 mm Pump x 0.984" / 25 mm Engine, B18
8.749-922.0	24 mm Pump x 3/4" Engine, B5
8.754-767.0	25 mm Pump x 1-1/8" Engine, B24
8.710-334.0	30 mm Pump x 1-1/8" Engine
8.710-336.0	24 mm Pump x 1-1/8" Engine
9.115-049.0	YGR100P 18-24HP

**ANTI-SEIZE COMPOUND**

Recommended for all metal-to-metal, power-drive assemblies. Facilitates removal after use.



- Copper-Graphite or Nickel
- Copper-graphite high-torque for high temperature to 1800°F
- Nickel continues to work up to 2400°F
- Stops rust, galling and seizure on pulley / shaft or gear / shaft interfaces

PART NO.	DESCRIPTION
8.704-638.0	Blister Pack, 1 application, Copper - Graphite
8.704-641.0	8 oz. Brush Top Can - Nickel

**GEARED REDUCTION UNITS - INTERPUMP / GENERAL PUMP**



For use with 1450 RPM Interpump, General Pumps & Admiral A-W99.

- Eliminates Belts, Pulleys and Belt Guards
- Engine-to-Pump Drive Units
- Improve Efficiency



**RS99:**  
2.4:1 Gear Reduction (3480 Engine RPM = 1450 RPM Pump) for 3-5 HP Briggs, Honda-Tecumseh-Kohler with 3/4" Shaft.



**RS151:**  
2.2:1 Gear Reduction (3190 Engine RPM = 1450 RPM Pump) for 7-18 HP Briggs, Honda Engines with 1" or 1-1/8" Shaft (must specify). Use with the appropriate size: "WS" Series Interpump, "TS" Series General Pump.

PART NO.	ENGINE SHAFT
RS-99	
8.710-321.0	3/4"
RS-151	
8.710-322.0	1"
8.710-324.0	1-1/8"

**PTO GEARED MULTIPLIER**



- 1 to 1.9 Speed Multiplier
- 1-3/8" Splined Shaft (Same shaft as standard tractor PTO)
- 540 RPM PTO speed multiplied to 1,026 RPM at pump shaft
- For Pumps with a 24 mm Shaft

PART NO.	DESCRIPTION
8.710-319.0	Gear Multiplier

**PUMPTech PUMP**

The Pumptech Pump is a twin plunger design originally used on the Hotsy model Sport 500.



- PSI Max: 1000
- GPM Max: 2.0

PART NO.	DESCRIPTION
8.715-240.0	Pump-Sport 500
8.707-369.0	Cranshaft
8.707-370.0	Seal Kit with Plunger
8.700-187.0	Check Valve Kit

**FLANGES - LEGACY**



- Direct attachment of Legacy Pumps to NEMA Standard C-Face Motors.

PART NO.	NEMA FRAME	PUMP SERIES
8.754-098.0	184 TC / 215 TC	GM
8.754-099.0	184 TC / 215 TC	GT-GX

**FLEX COUPLERS - LEGACY**



- Pump shaft couplers.
- Direct-drive self-adjusting resilient coupling Legacy pumps to NEMA Standard Motor Shafts.

PART NO.	MOTOR DRIVE COUPLING	PUMP SERIES
8.754-100.0	1-1/8" x 24 mm	GM
8.754-101.0	1-3/8" x 24 mm	GM
8.754-103.0	1-3/8" x 25 mm	GT-GX

**FLANGES - INTERPUMP / GENERAL PUMP**



- Direct attachment of Interpump / General Pumps to NEMA Standard C-Face Motors.

PART NO.	NEMA FRAME	PUMP FRAME SIZE
8.709-613.0	56 / 145TC	56 / 145TC
8.709-615.0	184TC*	184TC*
8.709-616.0	215TC**	215TC**
8.709-870.0	8-13 HP (G)	8-13 HP (G)

\*W995 / GD \*\*W913 / GM

**FLEX COUPLERS - INTERPUMP / GENERAL PUMP**



- 24 mm pump shaft couplers. Direct-drive flex coupling 24 mm Interpump / General and Admiral XLS Series pumps to NEMA Standard Motor Shafts.

PART NO.	NEMA FRAME	DRIVE SHAFT
<b>2-PIECE COUPLER</b>		
8.709-617.0	56 A	5/8"
8.709-619.0	145T	7/8"
8.709-621.0	184 T	1-1/8"
8.709-624.0	215 T	1-3/8"
8.709-869.0	Gas (Aluminum)	1"
8.701-262.0	Rubber Bumper - Replacement	

## PUMP TECHNICAL INFORMATION

Correct pump installation is essential for optimum performance. It is recommended that the pump flow capacity be oversized for the actual flow required. For optimum running of the system, the water circulated through the regulating valve should not exceed 10-15% of the pump flow. Recirculating too much water can generate heat in the supply tank increasing the cavitation risk.

### FREQUENTLY ASKED QUESTIONS

**How much should you reduce the pump RPM to achieve a lower flow capacity?**

$$\text{Required RPM} = \text{Expected Capacity} \times \frac{\text{Max RPM Allowed}}{\text{Max Allowed Capacity}}$$

**What diameter of pulley must I use to achieve the correct pump RPM?**

$$\frac{\text{External Diameter of the Engine}}{\text{Motor Pulley}} = \text{External Diameter of the Pump Pulley} \times \frac{\text{Pump RPM}}{\text{Engine / Motor RPM}}$$

**What if I cannot change the engine / motor pulley?**

$$\text{External Diameter of the Pump Pulley} = \frac{\text{External Diameter of the Engine}}{\text{Motor Pulley}} \times \frac{\text{Engine / Motor RPM}}{\text{Pump RPM}}$$

**If the engine / motor is running at a lower RPM than the maximum pump RPM allowed, what will be the pump flow capacity?**

$$\text{Attainable Maximum Capacity} = \text{Engine / Motor RPM} \times \frac{\text{Max Capacity Indicated on Label}}{\text{Max RPM Indicated on Label}}$$

**What is the approximate power required to achieve the maximum performances allowed?**

$$\text{Required Electric Motor HP} = \frac{\text{PSI} \times \text{GPM}}{1460} = \text{Electric Motor HP}$$

$$\text{Required Gas Engine HP} = \frac{\text{PSI} \times \text{GPM}}{1460} \times 1.30 = \text{Gas Motor HP}$$

### CONDITIONS TO PREVENT PUMP CAVITATION

Minimum difference in height HZ (Pos / Neg) between pump and water level.

The minimum inlet pressure value of the pump is limited by the cavitation phenomenon. Cavitation is the forming of vapor bubbles when the local pressure is below the vapor pressure of the liquid. Bubbles flow together with the liquid and when they reach a higher pressure area, they collide, generating abnormal stresses that are extremely dangerous to the pump components. To avoid the risk of cavitation, it is necessary that the pump installation is correct.

**YAMADA PUMPS**



Air-powered double diaphragm pump, "Reliable Performance Since 1905". The answer to difficult product transfer problems. Air-drive allows freedom from electrical hazards or explosion-proof motor requirements. Choose from various wetted-parts materials to customize the pump to the chemical being pumped. Yamada's smaller pumps are often used for pumping car wash chemical for 'low-pressure' functions. The 1/2" pump is also ideal for rapidly pumping oil, soap, etc., from 55 gallon barrels. Larger pumps are used for high-volume product transfer. Since all pumps are designed without rotating parts, they can also handle abrasive liquids such as ceramic slip, sand slurry or enamel frit without damage. Have a unique challenge? Call us for help!



8.702-180.0

8.702-183.0

- PSI: 100
- Temperature: 180°F
- Environmentally-Friendly Non-Lube Air Valve
- Automatic Start/Stop
- Non-Stalling Air Valve - Positive Switching Every Stroke and Won't Ice Up
- Outside Accessible Air Valve: Easy Inspection & Maintenance
- Bolted Flange Connections: Leak-free & Easy Maintenance
- Built-in Abrasion and Chemical-Resistance
- Virgin Diaphragm Material Lasts Twice as Long as Other Pumps
- With 20-100 PSI Drive Air:
  - 1/4" Model Delivers 3.4 GPM
  - 1/2" Model Delivers 15 GPM
  - 3/4" Model Delivers 19.5-27.3 GPM
  - 1" Model Delivers 35.7-48.3 GPM
- Infinitely Variable Flow Control Regulated by Opening or Closing Discharge Side Valve and/or Fluctuating Air Supply

PART NO.	INTAKE AND DISCHARGE	AIR INLET W/BALL VALVE	AIR EXHAUST W/B-I MUFFLED	PUMP BODY	DIAPHRAGM MATERIAL	MAX FLOW @ 100 PSI	MAX SOLID
8.702-180.0	1/4" FPT	1/4" FPT	3/8" FPT	Poly	Teflon®	3.4 GPM	N/A
8.702-201.0	3/8" FPT	1/4" FPT	3/8" FPT	Poly	Santoprene®	6 GPM	1/32"
8.702-182.0	1/2" FPT	1/4" FPT	3/8" FPT	Poly	Hytrel®	15 GPM	1/32"
8.702-183.0	1/2" FPT	1/4" FPT	3/8" FPT	Poly	Santoprene®	15 GPM	1/32"
8.702-184.0	1/2" FPT	1/4" FPT	3/8" FPT	Poly	Teflon®	15 GPM	1/32"
8.702-190.0	3/4" FPT	1/4" FPT	3/4" FPT	Poly	Teflon®	27.3 GPM	1/16"
8.702-192.0	1" FPT	3/8" FPT*	3/4" FPT	Poly	Neoprene	48.3 GPM	3/16"
8.702-193.0	1" FPT	3/8" FPT*	3/4" FPT	Poly	Hytrel®	48.3 GPM	3/16"
8.702-194.0	1" FPT	3/8" FPT*	3/4" FPT	Poly	Teflon®	48.3 GPM	3/16"
8.702-202.0	1-1/2" FPT	1/2" FPT*	3/4" FPT	Alum	Buna-N	116 GPM	9/32"

\*With air-cock instead of ball valve

**YAMADA PUMPS DIAPHRAGM KITS**



To minimize downtime, Yamada pumps are designed for quick, trouble-free maintenance. Pump diaphragms, balls and seats can be replaced in 20 minutes or less and with little chance of leaks commonly associated with other diaphragm pumps.

- Kits include everything required for routine maintenance



PART NO.	KIT	PUMP SIZE	YAMADA PUMP NO.
8.703-277.0	Teflon®	1/4"	100381
8.703-278.0	Hytrel®	1/2"	100383
8.703-279.0	Santoprene	1/2"	100384
8.703-281.0	Teflon®	1/2"	100385
8.703-282.0	Neoprene	3/4"	100391
8.703-283.0	Buna	3/4"	100392
8.932-947.0	Teflon®	3/4"	100394
8.703-284.0	Neoprene	1"	100396
8.703-285.0	Hytrel®	1"	100397
8.703-286.0	Teflon®	1"	100398
8.703-320.0	Buna	1-1/2"	100415

Note: Individual Components (O-rings or Diaphragms Only, For Example) Also Available. Call For Pricing and Delivery.



## UNLOADER VALVES - UU1 UNIVERSAL

The Legacy Universal Unloader is unique in that it allows for height or width adjustments making it ideal for any pump.



- PSI: 3500
- GPM: 6.0
- Temperature: 195°F
- Forged-Brass Body
- 1/2" NPT Inlet
- 3/8" NPT Outlet
- Stainless-Steel and low friction, wear-resistant plunger
- Weight: 16.1 oz.
- Patent US 8,313,311 B2'

PART NO.	DESCRIPTION
----------	-------------

<b>9.175-018.0</b>	Legacy Universal Unloader (UU1)
--------------------	---------------------------------



Note: Legacy Universal Unloader (UU1) will not fit Legacy Pump GF 3530F

### Adjusting inlet port



1.- Push up inlet port to make it shorter.

2.- Pull down inlet port to make it longer.





### Adjusting horizontal sliding connector



1.- Turn the connector clockwise direction to make it shorter.

2.- Turn the connector counterclockwise direction to make it longer.

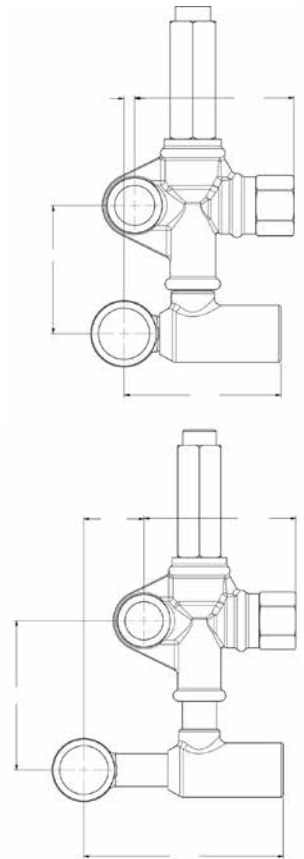

## UNLOADER VALVES - VBT SERIES

A trapped pressure direct mount unloader valve.



- GPM: 6.6
- Temperature: 195°F
- Weight: 1.95 oz.
- Brass, Stainless, Buna-N

PART NO.	DESCRIPTION	CONNECTION	PSI	FITS PUMP
<b>8.754-703.0</b>	Universal, VBT Direct Mount	3/8" FPT Inlet x 3/8" MPT Outlet	1500	FOG
<b>8.754-696.0</b>	Universal, VBT Direct Mount	1/2" FPT Inlet x 3/8" MPT Outlet	3000	LB, LP, LF
<b>8.754-700.0</b>	Universal, VBT Direct Mount	1/2" FPT Inlet x 3/8" MPT Outlet	4000	LB, LP, LF
<b>8.754-701.0</b>	Universal, VBT Direct Mount	1/2" FPT Inlet x 3/8" MPT Outlet	4000	LB, LP, LF
<b>8.754-702.0</b>	Universal, VBT Direct Mount	1/2" FPT Inlet x 3/8" MPT Outlet	4000	LM, LS

**UNLOADER VALVES - APR SERIES**

Integral Automatic Pressure Regulator for Admiral Pumps: WE - WG - WEL - XLS - XLE - XLG bolt on for Admiral and Legacy pumps. Trapped-pressure regulator specifically designed for use on the Admiral plunger pumps. Integral inlet, bypass and outlet eliminate the need for bypass hose.



- PSI: 3200
- GPM: 6.0
- Temperature: 195°F
- Forged-Brass Body
- 3/8" MPT Outlet
- Stainless-Steel Plunger and Seat Valve
- Weight: 29 oz.

8.703-401.0

PART NO.	DESCRIPTION	INLET
8.703-401.0	APR.I 25-Brass / Black	3/8"
9.802-365.0	APR.I 30-Brass / Black	1/2"
8.900-760.0	Seal Repair Kit	3/8"
8.900-761.0	Seal Repair Kit	1/2"

**UNLOADER VALVES - VR54/56**

Basic valves, premium performance.



- Temperature: 194°F
- Forged-Brass Body
- Stainless-Steel Seat and Piston
- 3/8" MPT Inlet, Outlet & 3/8 FPT Bypass

**VR54 Black Regulator / Unloader**

- PSI: 2030
- Max PSI: 2175 PSI
- GPM: 8.0
- Weight: 15 oz.

**VR54 Red Regulator / Unloader**

- PSI: 2610
- Max PSI: 2900 PSI
- GPM: 8.0
- Weight: 13.7 oz.

**VR56 Regulator / Unloader**

- PSI: 3625
- Max PSI: 3400 PSI
- GPM: 8.0
- Weight: 15 oz.

**Repair Kits**

- For Use with VR54/VR56 Regulator/Unloaders

PART NO.	DESCRIPTION
8.753-028.0	VR54 Black with Knob
8.753-029.0	VR54 Red with Knob
8.753-017.0	VR56 with Knob

**UNLOADER VALVES - VR53**



- PSI: 3630
- GPM: 8.0
- Temperature: 194°F
- 3/8" FPT Inlet and Outlet, 1/4" FPT Bypass
- Adjustable Pressure Setting Nut
- Heavy-Duty Forged-Brass Body
- Stainless-Steel Ball and Valve Seat
- High-Temperature Viton Seals
- Adjustable Upper-Pressure Limit Lock

PART NO.	DESCRIPTION	PSI	GPM
8.753-027.0	VR53 without Knob	3630	8
8.753-026.0	VR53 with Knob	3630	8

**UNLOADER VALVES - VR56/ VBA35 SERIES**



Commonly used on Legacy HD Pumps.



**VBA35**

- PSI: 3500
- GPM: 6.6

**VB56**

- PSI: 3650
- GPM: 8.0

PART NO.	DESCRIPTION	PSI	GPM
<b>VBA35 FOR LEGACY HD MODELS</b>			
9.803-899.0	GG, GD, GE	3500	6.6
9.803-900.0	GM, GS	4000	6.6
<b>VB56 FOR LEGACY HD MODELS</b>			
8.753-011.0	GM, GS	3650	8.0

**UNLOADER VALVES - VB3**

Commonly used on Legacy HD Pumps.



**VB3**

- PSI: 3200
- GPM: 6.5
- 3/8" NPT Inlet and Outlet and Bypass

PART NO.	DESCRIPTION	PSI	GPM
<b>VBA35 FOR LEGACY HD MODELS</b>			
8.725-384.0	VB3 3/8" NPT	3200	6.5

**UNLOADER VALVES - VRT3 SERIES**



Basic valves, premium performance.



- GPM: 8.0
- Temperature: 200°F
- Forged-Brass Body
- Stainless Internals
- 3/8" Inlet, Outlet, Bypass
- EZ Start models do not have dual inlets

PART NO.	DESCRIPTION	PSI	GPM
8.750-297.0	Yellow Spring	2320	8.0
8.750-298.0	Blue Spring	3630	8.0
8.750-299.0	Black Spring	4500	8.0
8.750-300.0	Black with EZ Start	4500	8.0
8.750-955.0	Black with Switch	4500	8.0
8.750-956.0	Black with Knob Switch	4500	8.0
8.750-821.0	Blue Spring w/o Knob	3630	8.0
REPAIR KITS			
8.750-709.0	Kit for Blue & Yellow Spring Unloaders	2320 / 3630	8.0
8.750-710.0	Kit for Black Spring Unloaders	4500	8.0
9.802-694.0	Old Style VRT3 Kit-605,606,607	Up to 4500	8.0

**UNLOADER VALVES - VRT100 HIGH-VOLUME SERIES**



- GPM: 26.4
- Temperature: 194°F
- 1/2" FPT, Inlet, Outlet & Bypass
- Stainless Internals
- Forged-Brass Body

PART NO.	DESCRIPTION	PSI	GPM
8.753-726.0	Blue with Knob	Up to 5075	26.4
8.753-443.0	Yellow without Knob	Up to 2760	26.4
8.753-444.0	Blue without Knob	Up to 5075	26.4
8.753-727.0	Blue with Microswitch 120 / 240 VAC - without Knob	Up to 5075	26.4
8.753-728.0	VRT100 Repair Kit	Up to 5075	26.4

Specifications, product descriptions, product availability, and pricing subject to change without notice.

**UNLOADER VALVES - PULSAR RV SERIES**



- GPM: 8.0
- Temperature: 195°F
- Pulsar RV Blue Rated 4050 PSI, Max PSI: 4500
- Pulsar RV White Rated 2300 PSI, Max PSI: 2600
- All Stainless-Steel Valves
- Pressure Actuated
- Forged Body
- 3/8" FPT Inlet, Outlet
- Two 3/8" FPT Bypass Ports

PART NO.	DESCRIPTION	GPM
8.754-867.0	Pulsar RV, White, with Knob	8.0
8.754-870.0	Repair Kit- Pulsar RV	8.0
8.754-866.0	Pulsar RV, Blue, without Knob	8.0
8.754-868.0	Pulsar RV, Blue, with Knob	8.0
8.754-869.0	Pulsar RV, Blue, with Knob & Switch	8.0

**UNLOADER VALVES - VB7 SERIES**



Fits GP/Interpump 63 Series, CAT 45F pumps as well as many other pumps requiring up to 8 GPM - 3650 PSI max pressure.



- PSI Max: 3650
- Temperature: 195°F
- Weight: 19.7 oz.

PART NO.	DESCRIPTION	PSI
8.712-741.0	without Knob, 3/8 MPT Inlet, 3/8 FPT Outlet & Bypass	3650
8.904-580.0	w/ Knob, 2.1 Fixed Inj., 3/8 MPT Inlet & Outlet	3650
8.704-488.0	Repair Kit	
8.712-735.0	Knob Only	

**UNLOADER VALVES - VB8 SERIES**



- Trapped Pressure
- 8 GPM
- 3200 MIN-3650 PSI Max
- Temp- 195 Deg

PART NO.	DESCRIPTION
9.802-362.0	w/ Knob & Switch, 5 Amp Microswitch, 3/8" MPT Inlet, 3/8" FPT Outlet & Bypass
8.757-462.0	w/o Knob, 3/8" MPT Inlet, 3/8" FPT Outlet

**UNLOADER VALVES - VB130/135 SERIES**



Trapped Pressure Unloader for the 51 & 60 Series pumps. Fits CAT 2SF pumps as well as others.



- PSI Max: 2600
- Temperature: 195°F
- 3/8" MPT Inlet and Outlet
- 3/8" FPT Bypass
- Stainless-Steel Plunger
- Stainless-Steel Valve Seat
- Weight: 14.7 oz.

PART NO.	DESCRIPTION	TEMP
8.712-739.0	VB 130 Without Knob	195°F
8.904-579.0	VB-135- with Knob, Banjo Connection, Hollow Screw Fitting	195°F
9.802-006.0	Repair Kit	195°F
8.712-735.0	Knob Only	195°F

**UNLOADER VALVES - VB85 / 280 SERIES**



Fits CAT 2SF pumps and other pumps. This pressure sensitive regulating unloader is designed for single or multiple pumps, weep or multi-nozzle systems.



- GPM: 21
- Temperature: 200°F
- Pressure Actuated
- Forged-Brass Body
- Stainless-Steel Plunger and Seat
- 1/2" FPT Inlet, Outlet, Bypass
- Weight: 45 oz.

PART NO.	DESCRIPTION	PSI	GPM	MAX PSI
8.751-964.0	VB85/ YUB21405, Blue Spring	4050	21	4500
8.751-963.0	VB85/ YUW21235, White Spring	2300	21	2600

**UNLOADER VALVES - VB80 / 400 STAINLESS-STEEL**



- Rated PSI: 5800, Max PSI: 6500
- GPM: 21.0
- Forged Stainless-Steel Body
- All Stainless-steel Valve Parts
- Viton Seals
- 1/2" FPT Inlet, Outlet, Bypass

PART NO.	DESCRIPTION	GPM	TEMP
8.712-656.0	VB 80/400 - YU2158	21	195°F
9.802-007.0	Repair Kit	21	195°F

**UNLOADER VALVES - VB200 HIGH-VOLUME SERIES**



Fits CAT 2SF pumps and other pumps.



- PSI: 2175
- GPM: 52.5
- Temperature: 194°F
- Steel and Brass Body
- Large Plastic Knob (Removable)
- Lock Nut on Pressure Adjustment
- 1" FPT Inlet, Outlet, Bypass
- Two 5/16" - 18 Bolt Mounting Ports
- Hexagonal shaped check valve to avoid jamming
- Weight: 73.5 oz.

PART NO.	DESCRIPTION	PSI	GPM
8.712-754.0	VB 200 without Knob	2200	52.5
8.712-755.0	VB 200 with Knob	2200	52.5
8.704-583.0	Repair Kit	2200	52.5

**UNLOADER VALVES - VB75 / VB135 SERIES**



The VB75 is an integrated unloader for Interpump and General Pump with 7.8 GPM - 3600 PSI max pressure. The VB135 fits Interpump "WW" Series pumps and General "TT" Series pumps with 6.5 GPM - 2600 PSI max pressure.

**VB75**

- Rated PSI- 3200, Max PSI 3650
- Temperature: 195°F
- 1/2" FPT Inlet, 1/4" FPT Gauge Port
- 3/8" FPT Outlet and Bypass
- Weight: 19.7 oz.

**VB135**

- Rated PSI: 2300, Max PSI: 2600
- Temperature: 195°F
- 3/8" FPT Inlet, 3/8" MPT Outlet
- 6.5 GPM
- Stainless Internals
- Forged-Brass Body
- Weight: 22.9 oz.



VB75



VB135

PART NO.	DESCRIPTION
<b>VB75</b>	
8.712-742.0	VB75 Direct Mount Control Set for EZ, 47, 60, 63 & W151 Series
8.704-488.0	Seal Kit
8.712-735.0	Knob Only
8.705-934.0	1/2" Bolt with Hole
<b>VB135</b>	
8.712-659.0	VB135- Direct Mount Control Set for WW & TT Series Pumps
8.712-735.0	Knob Only
9.802-006.0	VB 135 Repair Kit
8.705-935.0	3/8" Bolt with Hole

## UNLOADER VALVES - VB9 / VB10 TRAPPED PRESSURE SERIES



- PSI: 3600
- Rated PSI: 3200
- GPM: 8.0
- Instant Pressure Response
- Hex-Shaped Non-stick Check Valve
- 3/8" FPT Inlet, Outlet, Bypass
- Brass Valve Body / Stainless Ball and Seat
- Knob Included
- VB9 - Panel Mountable
- Reduces trapped pressure to 25% of operating pressure when unloading; allows easier gun trigger pull

PART NO.	DESCRIPTION
8.712-736.0	VB9 with Knob - YVB9K
8.715-462.0	VB9 with Knob and Pressure Switch - YVB9KMS2
8.715-489.0	VB9 with Check Valve and Pressure Switch - YVB9KMSS
8.712-745.0	VB10 with Knob - YU3678
8.704-548.0	Repair Kit VB9
8.704-561.0	Repair Kit VB10
8.901-056.0	Seal Kit VB10

## UNLOADER VALVES - VB350 / VB7 SERIES



Bigger. Stronger. Faster - 5650 PSI.



- PSI Max: 5650
- Rated PSI: 5075
- GPM: 10.0
- Temperature Max: 195°F
- Forged-Bronze Body
- Stainless-Steel Plunger and Valve Seat
- 3/8" FPT Outlet
- 1/2" F Bypass
- 3/8" MPT Inlet, 1/4" Gauge Port
- Weight: 31 oz.

PART NO.	DESCRIPTION	TEMP
9.802-360.0	Unloader, Red Knob (YU5075K)	195°F
9.800-106.0	Repair Kit, Red Knob	195°F
8.704-499.0	Repair Kit, Old VB 350	195°F

## UNLOADER VALVES - CONTROL SET "W" SERIES



Integrated Regulator & Unloader designed exclusively to fit Interpump & General Pump pumps.



- Mounts directly on pump inlet and outlet; internal bypass loop
- Pressure Actuated: "Instant-On"
- 3/8" MPT Inlet & Outlet, 1/4" HB (8.712-638.0, 8.712-643.0)
- 1/2" FPT Inlet, 3/8" MPT Outlet, 1/4" HB (8.712-644.0, 8.712-642.0, 8.712-647.0)
- Integrated Injector - Optional
- Pressure and flow-engineered for specific pump models

PART NO.	MODEL	GPM	PSI	PUMP
<b>"W" SERIES UNLOADERS WITHOUT INJECTORS</b>				
8.712-638.0	W1	3.0	1600	W905
8.712-643.0	W2	4.5	3000	W997
8.712-644.0	W2-L	6.0	3000	W201
8.702-883.0	W2 / W2L Rebuild Kit			
8.702-888.0	W1 / W1L Rebuild Kit			
<b>"W" SERIES UNLOADERS WITH INJECTORS</b>				
8.712-642.0	W2-1	4.5	3000	W997
8.712-645.0	W2L-1	4.5	3000	W201
8.712-647.0	W2L-2	6.0	3000	WS202
8.702-884.0	Injector Maintenance Kit			

## UNLOADER VALVES - KITS FOR K / ZK SERIES



Repair Kits for all K3, K5, K7 and K9 models.

PART NO.	DESCRIPTION
8.702-847.0	K5/K58 Maintenance Kit
8.702-849.0	K5/K60 Rebuild Kit
8.705-045.0	K5 Back Nut 3/4" NPT
8.702-858.0	K7/K70 Repair Kit
8.702-911.0	K9/K121 Repair Kit

**UNLOADER VALVES - K / ZK SERIES**



Unloaders relieve line pressure in bypass mode.



**ZK3 / ZK5**

- Temp: 165°F
- 3/8" FPT Inlet
- ZK3: 1500 PSI  
ZK5: 3000 PSI

**ZK1**

- Temp: 165°F
- 3/8" FPT Inlet
- 3600 PSI
- GPM: 2.3 - 10.8

**ZK7**

- Temp: 165°F
- 3/8" FPT Inlet
- 3500 PSI
- GPM: 2.11 - 10.8

**ZK9**

- Temp: 165°F
- 1/2" FPT
- 5800 PSI
- GPM 2.5 TO 13.2

PART NO.	MODEL	GPM	OUTLET
<b>ZK1</b>			
8.712-602.0	ZK138	2.30 - 10.80	3/8" M
8.712-601.0	ZK1	2.30 - 10.80	1/2" M
<b>ZK3</b>			
8.712-603.0	ZK3.0	2.10 - 3.00	3/8" M
8.712-605.0	ZK3.1	3.00 - 3.22	3/8" M
8.712-607.0	ZK3.2	4.22 - 5.55	3/8" M
8.712-609.0	ZK3.3	5.00 - 6.50	3/8" M
8.712-604.0	ZK3.0	2.10 - 3.00	1/2" M
8.712-606.0	ZK3.1	3.00 - 4.22	1/2" M
8.712-608.0	ZK3.2	4.22 - 5.55	1/2" M
8.712-610.0	ZK3.3	5.00 - 6.50	1/2" M
<b>ZK5</b>			
8.712-611.0	ZK5.1	3.00 - 4.22	3/8" M
8.712-613.0	ZK5.2	4.22 - 6.60	3/8" M
8.712-615.0	ZK5.3	6.60 - 10.83	3/8" M
8.712-612.0	ZK5.1	3.00 - 4.22	1/2" M
8.712-614.0	ZK5.2	4.22 - 6.60	1/2" M
8.712-616.0	ZK5.3	6.60 - 10.83	1/2" M
8.715-478.0	Bypass plate for ZK3 / ZK5		
Note: 1. Use 8.705-045.0 back nut on bypass nipple when mounting 1/2" bypass line on ZK3 and ZK5 series. 2. Use restricted .156-.225 ID orifice in bypass line for smoother operation / pressure balancing.			
<b>ZK7</b>			
8.712-617.0	ZK7.0	2.11 - 3.00	3/8" M
8.712-618.0	ZK7.1	3.00 - 4.22	3/8" M
8.712-619.0	ZK7.2	4.22 - 6.60	3/8" M
8.712-620.0	ZK7.3	6.60 - 10.8	3/8" M
8.701-386.0	ZK7 - #0 Bypass Orifice 2.2 mm		
8.701-389.0	ZK7 - #1 Bypass Orifice 2.5 mm		
<b>Z9</b>			
8.712-621.0	ZK9	2.50 - 13.20	1/2" M

**UNLOADER VALVES - HM MODEL**



- Pressure Adjustable: 0-3000 PSI
- Flow Range: 1.4 to 10.8 GPM
- Temperature: 185°F
- 3/8" FPT Inlet, Bypass, 3/8" MPT Outlet
- Excess Flow Bypassed to Maintain Selected Pressure
- Operates on Single / Multiple Gun Systems
- Brass Body, Stainless-Steel Valve & Seat

PART NO.	DESCRIPTION	PSI	GPM
8.712-622.0	HM Regulator / Unloader	0-3000	1.3-10.8
8.702-860.0	Repair Kit #72	0-3000	1.3-10.8

**UNLOADER VALVES - HYPRO-STYLE**



- PSI: 400 to 1500
- GPM: 4.0
- Temperature: 180°F
- 3/8" MPT Inlet and Outlet
- Buna Seals
- Weight: 8 oz.

PART NO.	PRESSURE	BYPASS	GPM
8.712-689.0	200-500	1/4" FPT	5.0
8.712-690.0	400-1000	1/4" FPT	5.0
8.712-691.0	800-1500	1/4" FPT	5.0
8.712-692.0*	400-1000		5.0
8.712-693.0*	800-1500		5.0
8.722-643.0	Repair Kit for All		

\*Bypass port not threaded, closed coupled

**UNLOADER VALVES - YU HIGH VOLUME**



- GPM: 21.0
- Temperature: 200°F
- 1/2" FPT Inlet and Outlet
- Two 1/2" FPT Bypass Ports
- Forged-Brass Body
- Stainless-Steel Internals

**YU-21235 YELLOW SPRING**

- PSI: 2300
- Rated Pressure: 2600 Max

**YU-21405 GREEN SPRING**

- PSI: 4050
- Rated Pressure: 4500 Max

PART NO.	DESCRIPTION	PSI
8.753-326.0	YU-21235 Yellow Spring	2600
8.753-168.0	YU-21405 Green Spring	4500

**UNLOADER VALVES - ST-230**



- PSI: 500 - 3600 PSI
- GPM: 8.0
- Temperature: 200°F
- 1/4" FPT Inlet and Bypass
- Mounts Off-Line - No Line Restrictions
- Brass Body, Stainless-Steel Piston & Seat
- Weight: 14 oz.

PART NO.	DESCRIPTION	GPM	TEMP
8.712-628.0	ST-230	8	200°F
8.757-359.0	Repair Kit	8	200°F

NOTE: Tamper proof wire and seal are not included

**UNLOADER VALVES - ST-280**



- PSI: 500 - 4060
- GPM: 8.0
- Temperature: 175°F
- Brass Housing, Stainless-Steel Valve
- 3/8" FPT Inlet, Outlet and 1/4" FPT Bypass
- Weight: 22.5 oz.

PART NO.	DESCRIPTION	PSI	GPM
8.712-674.0	ST-280	3600	8
8.701-654.0	Piston Seal Kit "C"	3600	8
8.701-653.0	Check Valve Kit "A"	3600	8

**UNLOADER VALVES - ST-261 SERIES**



ST-261 STD



ST-261/S



ST-261/I



ST-261/SI



ST-261 Bypass Switch Only

**ST-261 STANDARD**

- PSI Regulation: 0-3600
- GPM: 1.0 - 8.0
- Temperature: 176°F
- 3/8" FPT Inlet & Outlet  
1/4" FPT Bypass
- Stainless-Steel Plunger and Seat
- Forged-Brass Body and Viton Seals
- Weight: 22.5 oz.

**ST-261 / S UNLOADER WITH BYPASS  
ST-261 / I - UNLOADER WITH CHEMICAL INJECTORS  
ST-261 / SI UNLOADER WITH SWITCH AND INJECTOR**

- Micro Switch Specs; 115 VAC, 5A / 230 VAC, 3A
- Temperature: 176°F
- 3/8" FPT Inlet & Outlet  
1/4" FPT Bypass & Aux Port
- Siphon Rate- 10-1
- Switches at full bypass flow
- Wired N/C (may be wired N/O)

**ST-261 BYPASS SWITCH (ONLY)**

- Field-Mountable
- 10 AMP, 115 / 230V
- Switches at full bypass flow
- Wired N/C (may be wired N/O)

PART NO.	DESCRIPTION	PSI	GPM
<b>ST-261 STANDARD</b>			
8.712-681.0	ST-261 STD	0-3600	8
8.701-627.0	Repair Kit "B"	0-3600	8
8.701-650.0	Outlet Check Kit "A"	0-3600	8
<b>ST-261 / S- UNLOADER WITH BYPASS MICRO SWITCH</b>			
8.712-685.0	ST-261 / S	500-3625	8
8.701-647.0	Switch Seal Kit		
<b>ST-261 / I- UNLOADER WITH CHEMICAL INJECTORS</b>			
8.712-682.0	ST-261 / I / 1.8 mm	500- 3650	1.50-2.25
8.712-683.0	ST-261 / I / 2.1 mm	500- 3650	2.25-3.35
8.712-684.0	ST-261 / I / 2.4 mm	500- 3650	3.35-5.00
8.900-159.0	Injector Repair Kit without Barb		
8.701-648.0	Injector Repair Kit with Barb		
<b>ST-261 / SI- UNLOADER WITH MICRO SWITCH &amp; INJECTORS</b>			
8.712-686.0	ST-261 / SI-1		1.50-2.25
8.904-576.0	ST-261 / SI-2		2.25-3.35
8.904-577.0	ST-261 / SI-3		3.35-5.00
<b>ST-261 BYPASS MICRO SWITCH &amp; KIT</b>			
8.712-629.0	Complete Micro Switch Assembly		
8.701-642.0	Micro Switch Only		
8.701-647.0	Seal Kit - Micro Switch		

**UNLOADER VALVES - AR BOLT-ON**



- PSI Rated Pressure: 2600
- Fits RC, XT & XM Series Pumps
- 1/2" F Inlet
- 3/8" M Outlet

PART NO.	DESCRIPTION	GPM	BYPASS
8.712-582.0	AR20608 (4/B)	3.0-5.5	Aluminum, No Injector
8.712-564.0	AR20821 (3/B)	2.0-5.0	Aluminum, No Injector
8.712-573.0	AR20890 (4/B)	2.0-3.0	Aluminum, 2.0 Adj Injector
8.712-576.0	AR21039 (4/B)	2.0-3.0	Brass 2.0 Adj Injector
8.712-575.0	AR21040 (4/B)	3.0-4.0	Brass 2.2 Adj Injector
8.720-676.0	Seal Kit (4/B)		

Note: AR has discontinued the Combiset unloaders. Use Mini-Mate unloaders as replacements. For 22 mm twist coupler outlet models, add Part No. 8.709-546.0 (3/8" x 22 mm) to injector outlet.

**UNLOADER VALVES - GYMATIC - 3/B & VR35 3/B SERIES**



- PSI Rated Pressure: 3650
- GPM: 3.0-5.5
- Fits RK, RR, SXM, XM Series Pumps
- 3/8" M Outlet

PART NO.	DESCRIPTION	INLET
8.712-565.0	AR20242 (3/B)	1/2" F without Injector
8.712-563.0	AR20242G (3/B)	3/4" GHT & Filter, without Injector
8.712-574.0	AR20081 (3/B)	1/2" M Fixed Injector, 1.8 mm
8.712-567.0	AR20082 (3/B)	1/2" M Fixed Injector, 2.0 mm
8.712-568.0	AR20399 (3/B)	1/2" M Adj Injector, 1.8 mm
8.712-569.0	AR20400 (3/B)	1/2" F Adj Injector, 2.0 mm
8.720-642.0	AR2611 (3/B)	Repair Kit

**AR21669 - VR35 3/B**

- PSI Max: 4000
- GPM: 5.0
- Brass Bypass
- 1/2" M Inlet
- 3/8" M
- Without Injector

**AR24760 - VR35 3/B**

- PSI Max: 4000
- GPM: 5.0
- Brass Bypass
- 1/2" F Inlet
- 3/8" M Outlet
- Without Injector

PART NO.	DESCRIPTION	INLET	OUTLET
8.712-583.0	AR21669	1/2" M	3/8" M
8.720-903.0	AR24760	1/2" F	3/8" M

**UNLOADER VALVES - 22900A PRESSURE ACTUATED SERIES**



- Minimum PSI: 375 (Max PSI Listed Below)
- GPM: 2.2 - 13.0
- Temperature: 160°F
- Bellville Spring Washers Minimize Spikes
- Forged-Brass Bodies, Stainless Ball and Seat
- Four 1/4" Side Ports Enhance Versatility
- 1/2" FPT Inlet, Outlet and Bypass Ports
- Weight: 57.3 oz.

PART NO.	MODEL NO.	MAX GPM	MAX PSI	SPRING
8.712-709.0	22910A	13	800	Silver
8.712-710.0	22911A	13	1400	Yellow
8.712-711.0	22912A	13	2400	Red
8.712-708.0	22913A	13	3000	Orange
8.722-137.0	Repair Kit- 012099			

**UNLOADER VALVES - APM PRESSURE ACTUATED SERIES**



8.712-705.0



8.712-706.0

- Temperature: 160°F
- Unloads pressure in entire system when in bypass
- Forged-Brass Bodies
- Stainless-Steel Seat
- 3/8" FPT Inlet
- 3/8" FPT Outlet
- 1/4" FPT Bypass & Gauge Port

PART NO.	MODEL NO.	GPM	PSI
8.712-705.0	22760APM	8	145-3045
8.712-706.0	22765APM	5	580-4000



### UNLOADER VALVES - FLOW-ACTUATED



Designed for any pump that fits within the flow and pressure range of the unloader.



- Temperature: 160°F
- Unloads pressure in entire system when in bypass
- Forged-Bronze Body, Stainless-Steel Seat
- 3/8" FPT Inlet, 3/8" MPT Outlet
- 1/2" FPT Bypass

PART NO.	MODEL NO.	GPM	PSI
8.712-698.0	22650	3.0-4.5	0-3000
8.712-701.0	22654A	3.5-4.8	3000-4000
8.712-702.0	22655	4.5-5.5	0-3000
8.712-703.0	22656	4.5-6.5	0-3000
8.722-204.0	Seal Kit- 22666		

### PRESSURE RELIEF VALVES - SR/S3



For use as a backup to an unloader or main relief in an open system without a trigger operated spray gun.



- S-R Safety Valve:  
PSI: 3000  
GPM: 1.3 to 10.0  
3/8" M Inlet, 1/4" F Outlet
- S-3 Safety Valve:  
PSI: 500 to 10,000  
GPM: 2.6 to 26.4  
1/2" M Inlet, Side Discharge
- Bypass and Outlet
- Stainless-Steel Plunger and Seat
- Machined-Brass Bodies
- Adjustable Pop-Off Protection

PART NO.	DESCRIPTION	TEMP
8.711-215.0	S-R Valve/ ZKSR	165°F
8.711-227.0	S-3 Valve/ ZKS3	284°F

### PRESSURE RELIEF VALVES - TIMAX



- PSI Max: 870
- GPM Max: 53
- 3/4" F Inlet, 1/2" F, 1" F Bypass
- 1" FPT Bypass
- Brass-Body, Stainless-Steel Piston and Seat

PART NO.	DESCRIPTION	GPM	PSI
8.712-624.0	Timax Regulator Valve	53	870
8.702-844.0	Repair Kit		

NOTES: Lever control manual dump for bypass to relieve line pressure

### UNLOADER VALVES - MG4000 SERIES

"The world's best unloader valve" with a choice of PSI: 1500, 3000 or 4500.



- PSI: Up to 4500 PSI
- GPM: 10.0
- Temperature: 200°F
- Forged-Brass Body
- 3/8" FPT Inlet, Outlet and Bypass
- Auxiliary 1/4" Outlet
- Can be panel mounted
- Pressure limit indicated with color coded ring

PART NO.	DESCRIPTION	GPM	PSI
<b>WITHOUT KNOB</b>			
8.712-715.0	Yellow	10	1500
8.712-724.0	Black	10	4500
<b>WITH KNOB</b>			
8.712-716.0	Yellow	10	1500
8.712-719.0	Red	10	3000
8.712-725.0	Black	10	4500
8.704-567.0	Repair Kit- 463104K		



#### MG4000 WITH MICROSWITCH

- 15 Amp Microswitch
- Panel Mountable
- Use for time-delay shutdown or as burner control
- Can be used as Normally Open (NO) or Normally Closed (NC)

PART NO.	DESCRIPTION	GPM	PSI
8.712-720.0	Red	15	3000
8.712-714.0	Blue	15	4000
8.712-727.0	Black	15	4500



**PRESSURE RELIEF VALVES - VS 200 / 180, HIGH PSI**



Prompt and effective damping against pressure spikes



- Rated PSI: 2600, Max PSI: 2900
- GPM: 52.5
- Temperature: 194°F
- 3/4" FPT Inlet x 1/2" FPT Bypass
- Weight: 29.4 oz.

PART NO.	MODEL NO.	GPM
8.712-753.0	VS 200/180	52.5
8.704-582.0	Repair Kit	

**PRESSURE RELIEF VALVES - VS 350, HIGH PSI**



Prompt and effective damping against pressure spikes. Perfect For Multiple Gun Applications as well.



- PSI: 5600
- Rated PSI: 5100
- GPM: 6.5
- Temperature: 195°F
- 3/8" FPT Inlet, Outlet and Bypass
- Weight: 16.8 oz.

PART NO.	MODEL NO.	GPM	PSI
8.712-756.0	VS 350	6.5	5600
8.704-611.0	Repair Kit		

**PRESSURE RELIEF VALVES - VS 220**



- PSI Max: 3600
- Rated PSI: 3200
- GPM: 6.3
- Temperature: 200°F
- Two 3/8" FPT inlets
- 3/8" FPT Outlet and Bypass
- Forged-Bronze Body
- Stainless-Steel Plunger and Seat Valve
- Compact Design
- Weight: 14.2 oz.

PART NO.	MODEL NO.	GPM	PSI
8.712-737.0	VS220	6.3	3600
8.901-057.0	Repair Kit		

**PRESSURE RELIEF VALVES - VS 500, HIGH PSI**



- PSI Max: 8100
- Rated PSI: 7250
- GPM: 21
- Suitable to be utilized as a safety valve
- Temperature: 195°F
- Internals: Stainless-steel
- Brass Body and Fittings
- 1/2" FPT Inlet and 3/8" FPT Bypass
- Weight: 14.2 oz.

PART NO.	MODEL NO.	GPM	PSI
8.712-757.0	VS 500	21	8100

**REGULATING RELIEF VALVE**

Economical replacement for paraplate BR5 series.



- Adjustable Pressure: 200-2000 PSI
- GPM: 7
- Temperature: 200°F
- 3/8" FPT Inlet, Outlet and Bypass
- Flow-Thru Design for Smooth Operation
- Machined-Brass Body and Knob
- Stainless-Steel Plunger and Seal

PART NO.	DESCRIPTION	GPM	PSI
8.712-625.0	Relief Valve	7	200-2000
8.900-042.0	Repair Kit		

**UNLOADER VALVES - MOUNTING BLOCK**



End vibrator-caused fitting failure.



- GPM: 12
- Mounting Hardware Included
- Machine Block Brass or Steel

PART NO.	DESCRIPTION	MATERIAL	PSI
8.904-568.0	3/8" x 3/8"	Brass	5500
8.904-567.0	1/2" x 1/2"	Brass	5500
9.802-870.0	3/8" x 3/8"	Steel	
9.802-871.0	1/2" x 1/2"	Steel	

## CHEMICAL INJECTORS - AMERIMAX SERIES



The higher rate injector. Our best seller!



- PSI: 3500
- Brass Housing
- Stainless-steel Orifice & Spring
- Fully Adjustable Metering Valve
- 3/8" MPT Inlet, Outlet
- 1/4" Hose Barb

PART NO.	DESCRIPTION	GPM	PSI
<b>STANDARD</b>			
8.904-192.0	"0"	1.0-2.0	3500
8.904-193.0	"1"	2.0-3.0	3500
9.803-998.0	"2"	3.0-5.0	3500
8.904-194.0	"3"	5.0-8.0	3500
8.900-040.0	Repair Kit Stainless-steel Check Ball		
<b>"ACID" INJECTOR WITH SPECIAL INLET CHECK VALVE</b>			
8.904-201.0	"0A"	1.0-2.0	3500
8.904-202.0	"1A"	2.0-3.0	3500
8.904-203.0	"2A"	3.0-5.0	3500
8.904-204.0	"3A"	5.0-8.0	3500
8.700-536.0	Ceramic Ball for 8.904-203.0		
8.900-041.0	Acid Repair Kit*		

\*Ceramic Check Ball

## CHEMICAL INJECTORS - STAINLESS-STEEL



- PSI: 5000
- Stainless-Steel

PART NO.	DESCRIPTION	GPM	PSI
9.802-217.0	Non-Adjustable, Injector Only	3.0-5.0	5000
9.802-226.0	Complete Injector Assembly, with Hose & Filter	3.0-5.0	5000

## CHEMICAL METERING VALVES - ST-61



- Max Temperature: 140°F
- GPM: .27
- 1/4" Hose Barb
- Teflon® Seals
- Glass-Filled Polyamide Body and Valve Parts
- Adjusts From Off to Full Flow
- Snap-on attachment to ST-60, ST-62, ST-261/1

PART NO.	DESCRIPTION
8.710-777.0	ST-61, 1/4" Hose Barb, Teflon® Seals

## CHEMICAL INJECTORS - AMERIMAX SERIES - QUICK-COUPLED ASSEMBLIES



Assembled for added convenience - quick couplers to unloader outlet and quick couplers hose to injector outlet.



- Top quality quick couplers: 3/8" Plug Inlet, 3/8" Socket Outlet
- 6" industrial-grade poly-braid reinforced tubing (will not collapse, resists crimping, high-chemical tolerance)
- Heavy-duty brass chemical filter with check valve prevent loss of prime

PART NO.	DESCRIPTION	GPM
<b>AMERIMAX "QC"</b>		
8.904-195.0	Quick-Coupled "0"	1.0-2.0
8.904-196.0	Quick-Coupled "1"	2.0-3.0
8.904-197.0	Quick-Coupled "2"	3.0-5.0
8.904-199.0	Quick-Coupled "3"	5.0-8.0
8.900-040.0	Repair Kit Stainless-steel Check Ball	
<b>AMERIMAX ACID "QC"</b>		
8.904-206.0	Quick-Coupled "1A"	2.0-3.0
8.904-207.0	Quick-Coupled "2A"	3.0-5.0
8.904-208.0	Quick-Coupled "3A"	5.0-8.0
8.900-041.0	Acid Repair Kit*	

\*Ceramic Check Ball

## CHEMICAL INJECTORS - ST-60 SERIES



Requires ST-61 Metering Valve to regulate the chemical injection rate.



- Forged-Brass Body
- Compact Size
- PSI: 3600
- Siphon Rate: 10:1
- 3/8" MPT Inlet
- 3/8" FPT Outlet

PART NO.	DESCRIPTION	GPM	ORIFICE
8.710-476.0	ST 60/0	1.50-2.25	1.8 mm
8.710-477.0	ST-60/1	2.25-3.25	2.1 mm
8.710-478.0	ST-60/2	3.25-5.00	2.4 mm
8.701-648.0	Repair Kit with Barb-"F"		

## CHEMICAL INJECTORS - ST-64, UP STREAM



Apply soap at high pressure. Restricts waterflow to create suction. Used on Pressure Pro Equipment as well as other major manufacturers.

- PSI: 140
- Temperature: 160°F
- 3/4" FGH Inlet, 3/4" MGH Outlet
- Chemical strainer and 4' PVC tubing included
- Adjustable with ST-61 Metering Valve
- Locking Waterflow Adjustment



PART NO.	MODEL NO.	GPM	PSI
8.710-482.0	ST-64 Up Stream Injector	1.5-4.0	140
8.710-483.0	ST-64 Up Stream Injector	4.0-7.0	140

## CHEMICAL INJECTORS - ROBOKIM

- Rated PSI: 3200  
Max PSI: 3500
- Max Temperature: 210°F
- 3/8" MPT Inlet, Outlet
- 1/4" Hose Barb
- Stainless-Steel Orifice
- Stainless-Steel Inlet Check Valve Components



PART NO.	MODEL NO.	GPM	PSI	PSI
<b>ROBOKIM WITH PLASTIC METER KNOB</b>				
8.710-497.0	Chemical Injector "0"	2.1-2.9	3500	2.0 mm
8.710-498.0	Chemical Injector "1"	2.9-4.0	3500	2.2 mm
8.710-499.0	Chemical Injector "2"	4.0-5.5	3500	2.5 mm
8.710-500.0	Chemical Injector "3"	5.5-10.8	3500	2.75 mm
8.704-708.0	Repair Kit, RoboKim			

## CHEMICAL INJECTORS - ST-62 VARIABLE



Flow orifice adjusts for machines from 2-8 GPM. Requires ST-61 to regulate chemical injection rate.



- Max PSI: 36500
- GPM: 2.0 - 8.0
- Forged-Brass Body
- 3/8" FPT Inlet & Outlet

PART NO.	MODEL NO.	GPM	PSI
8.710-485.0	ST-62	8	3600
8.701-648.0	Repair Kit with Barb-"F"		

## CHEMICAL INJECTORS - ROBOKIM QUICK-COUPLED ASSEMBLIES



- Quick-Couplers:  
3/8" QC Plug Inlet  
3/8" QC Socket Outlet
- 6" industrial-grade poly-braid reinforced tubing
- AP brass chemical filter with stainless-steel check valve

PART NO.	DESCRIPTION	GPM
<b>ROBOKIM "QC" WITH PLASTIC KNOB</b>		
8.904-209.0	Chemical Injector "0"	2.1-2.9
8.904-210.0	Chemical Injector "1"	3.0-4.0
8.904-211.0	Chemical Injector "2"	4.0-5.5
8.904-212.0	Chemical Injector "3"	5.5-10.8
<b>ROBOKIM "QC" WITH BRASS KNOB</b>		
8.904-217.0	Chemical Injector "0"	2.1-2.9
8.904-218.0	Chemical Injector "1"	3.0-4.0
8.904-219.0	Chemical Injector "2"	4.0-5.5
8.904-220.0	Chemical Injector "3"	5.5-10.8

## CHEMICAL INJECTORS - HI-LO

May be used on high or low side of pump. Adjustable flow orifices plus adjustable chemical valves. Standard features similar to ST-62.

- Performance Range:
  - Low Side/Upstream: PSI: 10-120, GPM: .5-3.5
  - High Side/Downstream: PSI: 3500, GPM: 2.0-8.0
- Max Temperature: 180°F
- Machined-Brass Body
- 3/8" FPT Inlet, Outlet



PART NO.	MODEL NO.	GPM	PSI
8.710-486.0	Hi / Lo Injector with Meter Valve	2.0-8.0	3500
8.710-487.0	without Chemical Adjust	2.0-8.0	3500
8.700-290.0	Repair Kit		
8.900-044.0	Seal Kit		

## CHEMICAL INJECTORS - 400 SERIES

The injector of choice.



- PSI: 3200
- Temperature: 200°F
- Forged-Brass Housing
- Teflon® Valve Seat
- 3/8" Inlet, Outlet (3 Configurations)
- Renewable Orifices and Check Valve
- Options Include: Quick-Coupled, Stainless-Steel Orifices, Acid-Resistant Check
- Weight: 5 oz.

### ORIFICE SELECTION



ORIFICE DIA.	DESCRIPTION	GPM / FLOW RATE	PSI
1.6 MM	3/8" Inlet / Outlet	1.5-2.7	3200
1.8 MM	3/8" Inlet / Outlet	2.0-3.6	3200
2.1 MM	3/8" Inlet / Outlet	2.7-4.9	3200
2.3 MM	3/8" Inlet / Outlet	3.3-6.0	3200

### ADJUSTABLE INJECTORS, PRECISE NEEDLE-METERING VALVE

ORIFICE SIZE	M X M PART NO.	M X F PART NO.	F X M PART NO.
<b>BRASS BODY</b>			
1.6	8.710-541.0	8.710-549.0	8.710-559.0
1.8	8.710-535.0	8.710-543.0	8.710-551.0
2.1	8.710-537.0	8.710-545.0	8.710-554.0
2.3	8.710-539.0	8.710-547.0	8.710-557.0
<b>BRASS BODY / STAINLESS-STEEL INSERT</b>			
1.6	8.710-542.0	8.710-550.0	8.710-560.0
1.8	8.710-536.0	8.710-544.0	8.710-552.0
2.1	8.710-538.0	8.710-546.0	8.710-556.0
2.3	8.710-540.0	8.710-548.0	-
<b>BRASS BODY / ACID-RESISTANT</b>			
1.6	8.904-230.0	8.904-238.0	-
1.8	8.904-224.0	8.904-232.0	-
2.1	8.904-226.0	8.904-234.0	8.904-242.0
2.3	8.904-228.0	8.904-236.0	-
<b>BRASS BODY / STAINLESS-STEEL INSERT / ACID-RESISTANT</b>			
1.6	-	-	8.904-246.0
1.8	8.904-225.0	8.904-233.0	8.904-241.0
2.1	8.904-227.0	8.904-235.0	8.904-243.0
2.3	8.904-229.0	8.904-237.0	-

PART NO.	DESCRIPTION
<b>REPAIR KITS INCLUDE CHECK BALL, SPRING, SEAT AND O-RING</b>	
8.900-769.0	Standard Kit
8.900-770.0	Acid Kit

**CHEMICAL INJECTORS - STAINLESS-STEEL**



- PSI: 5500
- Temperature: 190°F
- 3/8" MPT Inlet, Outlet
- 1/4" Hose Barb
- 1.8 mm Orifice
- Weight 8.0 oz.
- High Draw: 20%

PART NO.	MODEL NO.	GPM	PSI
9.112-213.0	Chemical Injector	2.0-3.0	5500

**CHEMICAL INJECTORS - 505 SERIES STAINLESS-STEEL**



All metal parts are stainless-steel



- PSI: 5650
- GPM: 8.0
- Temperature Max: 195°F
- 3/8" Inlet, Outlet
- Premier Type Injector
- Teflon® O-Rings

PART NO.	MODEL NO.	GPM	PSI
8.710-586.0	Stainless-steel Injector 1.8	2.0-2.6	5650
8.710-587.0	Stainless-steel Injector 2.1	2.6-4.0	5650
8.710-588.0	Stainless-steel Injector 2.3	4.0-5.3	5650
8.704-027.0	Repair Kit		

**CHEMICAL INJECTORS - ADJUSTABLE, WITH QUICK-CONNECT**



- PSI: 3500
- Temperature Max: 200°F
- 3/8" M Plug Inlet
- 3/8" F Coupler Outlet
- 1/4" Hose Barb

PART NO.	MODEL NO.	GPM
8.710-502.0	Adjustable QC - 1.8 mm	2.0-3.0
8.710-503.0	Adjustable QC - 2.1 mm	3.0-5.0
8.710-504.0	Adjustable QC - 2.3 mm	5.0-8.0

**ACID INJECTORS**

8.904-221.0	Adjustable QC - 1.8 mm	2.0-3.0
8.904-222.0	Adjustable QC - 2.1 mm	3.0-5.0
8.904-223.0	Adjustable QC - 2.3 mm	5.0-8.0
8.701-187.0	Injector Repair Kit	
8.900-087.0	Injector Acid Kit	

**CHEMICAL INJECTORS - BRASS**

All metal parts are brass



- PSI: 4000
- Temperature Max: 190°F
- 3/8" Inlet, Outlet
- Premier Type Injector
- EPDM O-Ring

PART NO.	MODEL NO.	GPM	PSI
8.710-505.0	Brass Injector 1.8	2.0-2.6	4000
8.710-506.0	Brass Injector 2.1	2.7-4.0	4000
8.710-507.0	Brass Injector 2.3	4.0-5.3	4000
8.704-028.0	Repair Kit		

**CHEMICAL INJECTORS / PRESSURE REDUCER - EXTRACT-A-FLOW**

"Low side" chemical injector that regulates inlet pressure to maintain consistent chemical ratio.



- GPM: Up to 6.0
- 1/2" FPT I/O Ports
- 1/4" Hose Barb Chemical Inlet
- +2% Injection Ratio Variation

PART NO.	DESCRIPTION
8.711-162.0	Weep Seat*
8.711-160.0	Non-Weep
8.711-161.0	With Switch**
8.904-389.0	Hose Barb with Viton Check
8.904-390.0	Hose Barb with Buna Check

\*Weep Seat allows pump to self-prime  
 \*\*With burner control switch (9.802-362.0) automatically turns burner off when water flow stops

**FLOAT VALVES - ADJUSTABLE, BRONZE**



- Temperature Max: 180°F
- Cast-Bronze Body
- Adjustable Float Arm
- Live Rubber Stopper

PART NO.	THREAD	STEM	GPM AT 40 PSI
8.710-045.0	1"	1/4"-20	47
9.802-183.0	1"	1/2"-20	47

**REPAIR PARTS FOR ADJUSTABLE VALVES**

8.700-475.0	Long Arm*
8.700-476.0	Short Arm*
8.700-477.0	Thumb Screw*
8.700-479.0	3/8" and 1/2" Plunger

\*Fits 3/8", 1/2" and 3/4" valve only  
 Note: Float valve requires stem and float

### FLOAT VALVES - STEMS



PART NO.	LENGTH	THREAD
<b>BRASS</b>		
9.802-157.0	8"	1/4" - 20
8.710-051.0	10"	1/4" - 20
<b>STAINLESS-STEEL</b>		
8.710-047.0	8"	1/4" - 20 x 5/16" - 18

Parts for other float valves also available

### FLOAT VALVES - BALLS, COPPER & PLASTIC



PART NO.	LENGTH	THREAD
<b>COPPER</b>		
8.710-061.0	4" x 5"	1/4"-20
8.710-052.0	5"	1/4"-20
8.710-053.0	6"	1/4"-20
<b>PLASTIC</b>		
8.710-057.0	6"	1/4"-20
8.710-059.0	8"	1/4"-20
9.802-061.0	4" x 5"	1/4"-20

Parts for other float valves also available

### FLOAT VALVES - PA BRASS ASSEMBLY

Used on Pressure Pro Equipment as well as other major equipment manufacturers.



- Max GPM: 7.0
- Max PSI: 145
- Temperature: 140°F
- Brass Body
- Positional / Adjustable Arm

PART NO.	DESCRIPTION	INLET	TEMP
8.710-042.0	Float Valve	3/8" BSP-M	140°F
8.754-586.0	Float Valve	3/8" NPT-M	140°F
8.704-204.0	Repair Kit		

### FLOAT VALVES - ST-8, BRASS ASSEMBLY



Complete assembly includes valve, stem and float.



- GPM: 5.0
- Temperature: 175°F
- 1/2" FPT Inlet
- Brass Housing with Polyamide Cover

PART NO.	DESCRIPTION	GPM	TEMP
8.710-031.0	ST-8	5.0	175°F
8.710-033.0*	MPT Adapter Kit for ST-8		

\*Double MPT nipple, sealing washer and lock nut

### FLOAT VALVES - BRASS FLOAT WITH BALL & STEM



- Inlet PSI Max: 142
- GPM: 7.1 at PSI: 28
- 1/2" MPT Inlet
- Temperature: 140°F
- Positive Soft Buna / Brass Shut-Off
- Adjustable Float Ball Settings
- Inlet Nut and Washer Seal Provided

PART NO.	DESCRIPTION	PSI MAX	TEMP
8.710-037.0	Valve Complete	142	140°F
8.704-092.0	Repair Kit		

### FLOAT VALVES - DIAPHRAGM



- PSI: 142
- GPM: 7.86 at PSI: 28
- GPM: 6.68 at PSI: 14
- Temperature: 140°F
- 3/8" MPT Inlet
- Requires only 6.5" x 3" inside tank
- All-Plastic Snap-On Float
- Positive Shutoff Diaphragm Style
- Inlet Screen, Tank Gasket and Nut Included

PART NO.	DESCRIPTION	PSI	TEMP
8.710-030.0	Float Valve Complete	142	140°F

**FLOAT VALVES - VERTICAL**



- GPM: 8.0 at PSI: 150
- Temperature: 140°F
- 1/2" MPT Inlet
- Inlet Nut and Washer Seal Provided

PART NO.	DESCRIPTION	TEMP
9.802-185.0	Vertical Float Tank Valve, 1/2" MPT Inlet	140°F

**FLOAT VALVES - HUDSON**



- PSI: 0-130
- Temperature: 90 & 150°F
- No External Moving Parts
- No Float Ball or Arm
- All Plastic, Nylon, Rubber and Stainless-Steel
- 1" Inlet - Easy Installation
- Automatic Anti-Siphon
- Flow Capacity 80% of Supply: GPM:40 at PSI: 40

PART NO.	DESCRIPTION	PSI	TEMP
8.710-035.0	1" Hudson Float Valve, 90°	0-130	90°F
8.710-036.0	1" Hudson Float Valve, 150°	0-130	150°F

**FLOAT VALVES - KERICK**



**FLOW RATE FOR 1/2" VALVE**

- PSI: 20 at GPM: 7.7
- PSI: 30 at GPM: 9.1
- PSI: 40 at GPM: 10.5
- PSI: 50 at GPM: 11.4
- PSI: 60 at GPM: 12.5

**FLOW RATE FOR 3/4" VALVE**

- PSI: 30 at GPM: 13
- PSI: 60 at GPM: 16.5

PART NO.	DESCRIPTION	ORIFICE
8.749-328.0	1/2" Float Valve	.25"
8.749-329.0	3/4" Float Valve	.30"

**FLOAT VALVES - BRASS**

- MTM / Veloci
- Includes Filter and Pipe

PART NO.	DESCRIPTION
8.754-085.0	Float Valve 3/4" M with Filter and Pipe

**CHECK VALVES - SWING ACTION, LOW PSI**



Retain prime on pumps with low-lift capability.



- PSI: 150
- Brass Body, Swing (flapper) Action
- FPT Inlet, Outlet
- Gravity Seal, No Spring Pressure

PART NO.	DESCRIPTION	PSI
8.709-378.0	1/2", FPT Inlet / Outlet, Gravity Seal	150
8.709-379.0	3/4", FPT Inlet / Outlet, Gravity Seal	150
8.709-380.0	1", FPT Inlet / Outlet, Gravity Seal	150
8.709-381.0	1-1/4", FPT Inlet / Outlet, Gravity Seal	150

**CHECK VALVES - STAINLESS-STEEL, HIGH PSI**

Holds pump prime without overloading pump suction.



- PSI: 6500
- Rated PSI: 5800
- Temperature: 195°F
- Female x Female
- Weight: 2.0 oz.

PART NO.	DESCRIPTION	FLOW RATE	PSI
8.709-361.0	1/4" F x F	6.1	6500
8.709-362.0	3/8" F x F	10.5	6500



### CHECK VALVES - 460 SERIES, HIGH PSI

Holds pump prime without overloading pump suction



8.709-356.0

- Max PSI: 2500
- Buna Seals

8.709-357.0

- Stainless-Steel Check Ball & Spring
- Machined-Brass Body

8.709-358.0

PART NO.	DESCRIPTION	CRACKING PRESSURE
<b>2500 PSI MINIATURE BALL CHECK</b>		
8.709-356.0	1/4", M x F	1 PSI
8.709-357.0	1/4", M x M	3 PSI
<b>3000 PSI STAINLESS GUIDED BALL AND QUAD RING SEAT</b>		
8.709-358.0	1/4", F x F	1 PSI
8.709-359.0	3/8", F x F	3 PSI

### CHECK VALVES - SPRING LOADED, HIGH PSI

Holds pump prime without overloading pump suction.



- PSI: 1200
- Max Temperature: 250°F
- Cracking Pressure PSI: 1
- Machined-Brass Body
- Stainless Steel Springs
- Poppet Seal

PART NO.	DESCRIPTION	MATERIAL
8.709-351.0	1/4", F x F	Machined Brass Body
8.709-352.0	3/8", F x F	Machined Brass Body
8.709-353.0	1/2", F x F	Machined Brass Body
8.709-354.0	3/4", M x M	Machined Brass Body

### CHECK VALVES - SPRING LOADED, LOW PSI

Holds pump prime without overloading pump suction



- PSI: 150
- Max Temperature: 250°F
- Machine-Cast Brass Bodies
- FPT x FPT
- Mount Horizontal or Vertical

PART NO.	DESCRIPTION	PSI	TEMP
8.709-384.0	1/2"	150	250°F
8.709-385.0	3/4"	150	250°F
8.709-386.0	1"	150	250°F

### CHECK VALVES / BACKFLOW PREVENTOR - T533 MODEL, VACUUM BREAKER

Protects water supply from harmful chemical backflow - will not allow "spike" pressure to push chemicals into supply line. Now required by many city and state regulations.



- Max PSI: 125
- Max Temperature: 180°F
- Machined-Brass Housing, Chrome Plated Finish
- Plastic Diaphragm Check
- 3/4" Female Garden Hose Inlet (with Lock Screw)
- 3/4" Male Garden Hose Outlet

PART NO.	DESCRIPTION	MATERIAL
8.705-039.0	Backflow Preventor	Machined Brass Housing

### CHECK VALVES - PVC, LOW PSI

Holds pump prime without overloading pump suction.



- PSI: 125
- Cracking Pressure PSI: 1
- Temperature: 180°F
- Choice of Connects
- PVC Plastic Body
- Stainless-Steel Ball Check
- Designed for Harsh Chemical Applications

PART NO.	DESCRIPTION	PSI	TEMP
8.709-366.0	1/4" MPT x 1/4" Barb	125	180°F
8.709-367.0	1/4" Barb x 1/4" MPT	125	180°F
8.709-369.0	1/4" Barb x 1/4" Barb	125	180°F
8.709-370.0	3/8" Barb x 3/8" Barb	125	180°F
8.709-373.0	1/2" Barb x 1/2" Barb	125	180°F

\*8.709-373.0 has Viton Seals

**BALL VALVES - STAINLESS-STEEL, LOW PSI**



- PSI: 2000 at Temperature: 180°F
- PSI: 1000 at Temperature: 300°F
- PSI: 300 at Temperature: 350°F
- Full-Flow Ports
- Investment Cast Process
- Two-Piece 316 Stainless Bodies
- Glass-Filled Telfon® Seals

PART NO.	DESCRIPTION
8.709-265.0	1/4" F x F, Glass-filled Teflon® Seals
8.709-266.0	3/8" F x F, Glass-filled Teflon® Seals
8.709-268.0	1/2" F x F, Glass-filled Teflon® Seals
8.709-269.0	3/4" F x F, Glass-filled Teflon® Seals

**BALL VALVES - FORGED-BRASS, LOW PSI**



- PSI: 600
- Temperature: 180°F
- Forged-Brass Body
- Full-Flow Ports
- Telfon® PTFE Seals

SIZE	M X F PART NO.	F X F PART NO.	M X M PART NO.
1/4"	8.709-249.0	8.709-250.0	-
3/8"	8.709-252.0	8.709-253.0	8.709-254.0
1/2"	8.709-255.0	8.709-256.0	8.709-257.0
3/4"	8.709-258.0	8.709-259.0	8.709-260.0
1"	8.709-261.0	8.709-262.0	8.709-263.0

**BALL VALVES - MINI, LOW PSI**



- PSI: 600
- 180° Handle Movement
- Forged-Brass Body

SIZE	M X F PART NO.	F X F PART NO.	M X M PART NO.
1/8"	8.709-208.0	8.709-209.0	-
1/4"	8.709-211.0	8.709-212.0	8.709-213.0
3/8"	8.709-216.0	-	-

**BALL VALVES - NICKEL-PLATED BRASS, LOW PSI**



- Threaded FPT Connects
- Chrome-Plated Ball
- Full-Flow Bore
- Seats and Seals have Glass-Filled Teflon®
- Nickel Plated Brass Body

PART NO.	DESCRIPTION	PSI
8.709-242.0	1/4", Chrome-plated Ball, Full-flow Bore	710
8.709-243.0	3/8", Chrome-plated Ball, Full-flow Bore	710
8.709-244.0	1/2", Chrome-plated Ball, Full-flow Bore	710
8.709-245.0	3/4", Chrome-plated Ball, Full-flow Bore	570
8.709-246.0	1", Chrome-plated Ball, Full-flow Bore	570
8.709-247.0	1-1/4", Chrome-plated Ball, Full-flow Bore	430
8.709-248.0	1-1/2", Chrome-plated Ball, Full-flow Bore	430
8.709-264.0	2", Chrome-plated Ball, Full-flow Bore	360

**BALL VALVES - RKH SERIES - STAINLESS-STEEL, HIGH PSI**



- 316 Stainless-Steel Body, Ball and Stem
- Viton O-Rings
- Delrin Ball Seats
- Full Port

PART NO.	FPT	PSI
8.709-277.0	3/8" x 3/8"	5880
8.709-280.0	1/2" x 1/2"	5880
8.709-283.0	3/4" x 3/4"	5154
8.709-286.0	1" x 1"	5154

**BALL VALVES - SHUT-OFF, HIGH PSI**



- Max PSI: 3000
- Max Temperature: 176°F
- Nickel Plated Brass Body

PART NO.	DESCRIPTION	PSI
8.753-959.0	3/8 FPT x 3/8 FPT	3000
9.113-462.0 <b>NEW</b>	3/8" FPT x FPT	5000

**BALL VALVES - BKH SERIES, HIGH PSI**



- Rugged Carbon Steel Construction
- 2-Way
- NPT (F x F) Threads
- Blow-Out Proof Stems
- Delrin Ball Seats
- Buna O-Rings

PART NO.	FPT	PSI
8.709-274.0	1/4" x 1/4"	7350
8.709-276.0	3/8" x 3/8"	7350
8.709-279.0	1/2" x 1/2"	7350
8.709-282.0	3/4" x 3/4"	5880
8.700-270.0	Replacement Handle (fits all sizes above)	
8.700-271.0	Replacement Screw for Handle	

**BALL VALVES - PVC, LOW PSI**

Great for chemical on / off flow control.



- PSI: 125
- Temperature: 140°F
- Flag Handle
- PVC and Nitrile Material
- Chemical and Impact Resistant

PART NO.	DESCRIPTION	PSI
8.709-214.0	1/4" Panel Mtg, Barb x Barb	125
8.709-219.0	1/4" In-line, Barb x Barb	125
8.709-220.0	3/8" In-line, Barb x Barb	125

**BALL VALVES - STAINLESS-STEEL, LOW PSI, ONE PIECE**



- PSI: 800 at Temperature: 300°F
- PSI: 400 at Temperature: 350°F
- Standard Port
- 316 Stainless-Steel Body
- Suitable for Steam

PART NO.	FPT	MATERIAL
8.709-287.0	1/4" x 1/4"	316 Stainless-steel Body
8.709-288.0	3/8" x 3/8"	316 Stainless-steel Body
8.709-290.0	3/4" x 3/4"	316 Stainless-steel Body

### BALL VALVES - 2940/3830 MINI SERIES, LOW PSI



- PSI: 147 Working Pressure
- Nickel Plated Brass
- Brass Housing-Hex Bar
- Compact Knob Operation
- Designed to fit tight quarters
- Telfon® Seals

PART NO.	DESCRIPTION
8.709-270.0	Series 3830 - Nickel Plated Brass, 1/8" x 1/8" FPT
8.709-271.0	Series 3830 - Nickel Plated Brass, 1/4" x 1/4" FPT
8.709-272.0	Series 2940 - Brass, 3/8" x 3/8" FPT
8.709-273.0	Series 2940 - Brass, 1/2" x 1/2" FPT

### BALL VALVES - T-601 SERIES COMPACT PVC, LOW PSI



- PSI: 150 Working Pressure
- Temperature: 140°F
- FPT Thread Both Ends
- Easy-Turn Handle
- EPDM Seals - White Body

PART NO.	FPT
8.709-233.0	1/4" x 1/4"
8.709-234.0	1/2" x 1/2"
8.709-235.0	3/4" x 3/4"
8.709-236.0	1" x 1"
8.709-237.0	1-1/4" x 1-1/4"
8.709-238.0	1-1/2" x 1-1/2"
8.709-239.0	2" x 2"

### BALL VALVES - MODEL 727, 3 WAY



- PSI Max: 500
- Temperature Max: 180°F
- Telfon® Seat & Stainless Handle Screw
- Buna Seals
- Brass

PART NO.	DESCRIPTION	PSI	TEMP
8.709-207.0	1/4" M x F x F	500	180°F

### BALL VALVES - 454 SERIES, POLYPROPYLENE, LOW PSI

Full port reinforced polypropylene body for strength & chemical resistance.



8.709-222.0    8.709-228.0

- Max PSI: 240 Working Pressure
- Teflon Seats for smooth operation & proper sealing.
- Double EPDM O-Rings in Stem for "No Leak"
- Threaded Mounting Brass Inserts on 1-1/4" - 2" Sizes
- 8mm Mounting Inserts

PART NO.	FPT
<b>TWO-WAY BALL VALVES</b>	
8.709-222.0	1/2" x 1/2"
8.709-223.0	3/4" x 3/4"
8.709-224.0	1" x 1"
8.709-225.0	1-1/2" x 1-1/2"
8.709-226.0	2" x 2"
<b>THREE-WAY BALL VALVES</b>	
8.709-227.0	1/2" x 1/2" x 1/2"
8.709-228.0	3/4" x 3/4" x 3/4"
8.709-229.0	1" x 1" x 1"
8.709-230.0	1-1/4" x 1-1/4" x 1-1/4"
8.709-231.0	1-1/2" x 1-1/2" x 1-1/2"
8.709-232.0	2" x 2" x 2"

### CHEMICAL METERING VALVES - FLOW SELECTOR, 3 & 4 WAY

3-way and 4-way lever control with brass body.



- 3-Way
- Plumb for 2 Inlets and 1 Outlet or 1 Inlet and 2 Outlets
- 4-Way
- Plumb for 3 Inlets and 1 Outlet or 1 Inlet and 3 Outlets
- Rated Temperature: 180°F

PART NO.	DESCRIPTION	TEMP
8.710-108.0	1/4" FPT 3-Way	180°F
8.710-110.0	3/8" FPT 3-Way	180°F
8.710-113.0	1/4" FPT 4-Way	180°F
8.710-114.0	3/8" FPT 4-Way	180°F

### CHEMICAL METERING VALVES - SERIES 28, FLOW CONTROL



- PSI: 150
- Rated Temperature: 175°F
- Forged-Brass, Nickel-Plated Body
- Panel Mtg in 17/32" Hole
- Compact Size
- Double-Stem Seal

PART NO.	DESCRIPTION	TEMP	PSI
8.710-775.0	1/4", FPT Inlet/Outlet	175°F	150
8.710-776.0	3/8", FPT Inlet/Outlet	175°F	150

### CHEMICAL METERING VALVES - BRASS



- PSI: 400 - 450
- Rated Temperature: 100°F
- 1/4" Inlet, Outlet
- Easy-Grip, Fluted Plastic Handle with Pointer
- Brass Body, Viton gland seal eliminates air leaks
- Panel Mount 11/16" or 3/4" Hole
- Extremely Compact T-Style

PART NO.	DESCRIPTION	PSI
8.710-773.0	"T" 1/4" F x F, Forged	440
9.802-188.0	"L" 1/4" M x M	440

### CHEMICAL METERING VALVES - SERIES 28, FLOW CONTROL



9.802-187.0



9.802-532.0

- PSI: 4000
- GPM: 6
- 1/4" Inlet, Outlet
- Adjusts from off to full flow
- 9.802-187.0 has presettable limiting orifice
- Forged-Brass Body

PART NO.	DESCRIPTION	PSI
8.710-771.0	Flow Control	4000
9.802-187.0	Flow Control with Bottom 4000 Locking Adjustment	
9.802-532.0	Valve, Less Solenoid	4000

Specifications, product descriptions, product availability, and pricing subject to change without notice.

### CHEMICAL METERING VALVES - FLOW CONTROL



The valve that "seals" (will not suck air).



- PSI: 3500
- Rated Temperature: 195°F
- 28" Vacuum - No Leak
- Viton Gland Seal Isolates Metering Threads from Solution
- Stainless-Steel Needle, Brass Seat
- 1/4" FPT Ports
- Heavy-Duty Brass Bar Stock Body
- Panel Mounts 5/8" Hole
- Large Easy-Grip Four-Lobe Handwheel
- Aluminum or Poly Available

PART NO.	DESCRIPTION	PSI
8.904-362.0	Metering Valve, Aluminum Knob	3500
8.904-361.0	Metering Valve, Poly Knob	3500
8.740-083.0	Replacement Knob	

### CHEMICAL METERING VALVES - DUAL - ST-66 MODEL



Chemical flow can be metered and shut off remotely from the injector. With two inlets, it also allows switching from one solution to another.



- Double-Metering Dial with Center OFF
- Panel Mount in Single 5/8" Hole
- Two Input Barbs - for Different Chemicals to Single Outlet Barb

PART NO.	DESCRIPTION	PANEL MOUNTING
8.710-779.0	ST-66	Single 5/8" Hole

### THERMAL RELIEF VALVE / PUMP PROTECTOR - COMPACT



- With and W/out 90° Hose Barb

PART NO.	SIZE	90° BARB	"TRIP" TEMP
8.712-544.0	1/4" MPT	No	145°F
8.712-545.0	3/8" MPT	No	145°F
9.802-181.0	3/8 MPT	Yes	145°F
9.804-025.0	1/4" MPT	Yes	145°F
8.707-250.0	3/8 MPT	Yes	190°F
9.803-670.0	1/2" MPT	Yes	190°F
8.707-256.0	1/2" MPT	Yes	145°F

### REGULATOR VALVE - STEAM

For "combo" hot pressure washer / steamer units. The single-turn on / off diverter valve bypasses pump flow to reduce water flow to the coil, creating steam in place of normal hot water.



- PSI: 4000
- Rated Temperature: 175°F  
Max Temperature: 300°F
- 1/4" MPT Inlet, Outlet
- Panel Mount in 11/16" or 3/4" Hole
- Machined-Brass Body
- Easy-Grip Plastic Knob

PART NO.	ORIFICE (MM)	PSI
8.711-263.0	0.8	4000
8.904-406.0	1.2	4000
8.904-407.0	1.5	4000
8.904-408.0	1.8	4000
8.904-409.0	2.0	4000

### THERMAL RELIEF VALVE / PUMP PROTECTOR



A must for any pump that might ever be left in bypass mode (unloading) for more than 15 seconds. Protects the pump from



overheating caused by recirculating water.

- Installs in Bypass Line
- Automotive Style Wax Element
- Automatically Resets at Cool Down to 115°F+
- No Adjustment Required
- 1/8" FPT Side Discharge
- PSI: 125 Inlet Pressure
- GPM: 2.5

PART NO.	INLET	GPM	"TRIP" TEMP
8.904-565.0	3/8" MPT	2.5	140°F
8.904-566.0	1/2" MPT	2.5	140°F
8.723-943.0	1/2" MPT	2.5	165°F

### RUPTURE DISKS



- Temperature: 225°F
- 3/8" Inlet x 1/2" MPT Outlet
- Prevents dangerous thermal expansion of water in the coil
- Ensures operator safety

PART NO.	DESCRIPTION	MAX PSI
9.802-192.0	Assembly	7000
8.707-381.0	Assembly	8500

### THERMAL RELIEF VALVE / PUMP PROTECTOR - TRV



- PSI: 145
- Opens Temperature: 135°F
- Low Profile
- Brass Body
- Plastic-Covered Barb

PART NO.	DESCRIPTION	PSI
8.712-547.0	3/8" Inlet, Low Profile, Brass Body	145
8.712-548.0	1/2" Inlet, Low Profile, Brass Body	145

### PRESSURE RELIEF VALVES



Commonly referred to as a Pop-Off Valve.



- Temperature: 160°F
- GPM: 10
- MPT Inlets x End Vent Outlets
- Machined Brass
- Automatically Resets
- Prevents pressure overloads, protecting people and equipment

PART NO.	DESCRIPTION	MAX PSI
8.722-192.0	1/4", Silver Spring	1200
8.722-193.0	1/4", Red Spring	2400
8.722-194.0	1/4", Orange Spring	3600
8.722-190.0	3/8", Orange Spring	3600
9.802-191.0	3/8", Blue Spring	5000

### AIR VALVE - COIL BLOW OUT

Also good for water tank blowouts as well as blowing out irrigation lines.



- Threaded Connection
- 1/8" Brass Valve
- 1/8" Model is Stainless-Steel
- Valve Cap Included

PART NO.	DESCRIPTION
8.705-047.0	Stainless-steel, 1/8" MPT Connect
8.705-048.0	Lead Free Brass, 1/4" MPT Connect
8.707-314.0	Valve Assy, Water Tank Blow-Out

**FLOW METERS - VISI - FLOAT**



- Installs in Bypass Line
- Automotive Style Wax Element
- Automatically Resets at Cool Down to 115°F+
- No Adjustment Required
- 1/8" FPT Side Discharge
- PSI: 125 Inlet Pressure
- GPM: 2.5
- 2" Scale

PART NO.	GPH	MATERIAL	METERING VALVE
8.710-097.0	.6-5	Brass	No
8.710-098.0	.6-5	Brass	Yes
8.710-101.0	2-10	Brass	No
8.710-102.0	2-10	Brass	Yes
8.710-099.0	.6-5	Stainless-steel	No
8.710-100.0	.6-5	Stainless-steel	Yes
8.710-104.0	2-10	Stainless-steel	No
8.710-105.0	2-10	Stainless-steel	Yes

Note: All flow measurements must be on low-pressure side of pump

**PRESSURE RELIEF VALVE - EASY-START, HIGH PSI**



- Rated PSI: 4050  
Permissible PSI: 4500
- Temperature: 176°F
- GPM: 8.0
- 3/8" MPT Inlet
- Hose Barb Outlet (8 mm)
- Machined-Brass Body
- Stainless-Steel Spring and Ball

PART NO.	DESCRIPTION	GPM	PSI
8.709-867.0	Easy-Start Valve	8.0	4500

**PRESSURE GAUGES - PORT KIT**



- PSI: 5000 Cold Water
- 1-3/4" Gauge
- 3/8" QC Socket
- 3/8" QC Plug

PART NO.	DESCRIPTION	QC SOCKET / PLUG
8.712-208.0	Pressure Gauge Kit	3/8" / 3/8"

**PRESSURE RELIEF VALVE - EASY-START, LOW PSI**



- Temperature: 195°F
- Machined-Brass Housing
- GPM: 8.0
- Stainless-Steel Internals

PART NO.	DESCRIPTION	INLET / OUTLET	PSI
9.804-065.0	Easy-Start Valve	1/4" MPT, 1/8" FPT	5000
9.802-190.0	Easy-Start Valve	3/8" MPT, 1/8" FPT	5000
8.709-865.0	Easy-Start Valve	3/8" MPT, 1/4" Barb	4100
8.709-866.0	Easy-Start Valve	3/8" MPT, 1/8" FPT	3500
8.751-265.0	Easy-start Valve	3/8" MPT, 5/16" HB	5000
9.802-137.0	Hose Barb (only) - 1/4" Barb x 1/8" MPT		

**PRESSURE GAUGES - 100 SERIES PNEUMATIC**



- Black Lacquered Steel Case
- Bronze Bourdon Tube
- Dry Gauge
- 1/4" NPT Brass Mounting Stem
- Accuracy + 3-2-3%

PART NO.	PRESSURE RANGE	MOUNTING STEM
<b>2" BOTTOM MOUNT</b>		
8.710-307.0	0-60	1/4" NPT Brass
8.710-308.0	0-100	1/4" NPT Brass
8.710-309.0	0-200	1/4" NPT Brass
8.710-310.0	0-300	1/4" NPT Brass

**PRESSURE GAUGE - FUEL / OIL**



- PSI: 0-200
- Perfect for Testing Burner Pump Fuel Pressure
- Metal Housing
- 2" Bottom Mount, 1/4" NPSM

PART NO.	DESCRIPTION	PRESSURE RANGE
8.700-738.0	Fuel Oil Pressure Gauge	0-200 PSI

NOTE: NPSM - American National Straight Pipe Threads

**PRESSURE GAUGES - ABS, CORROSION-RESISTANT**



- 2-1/2", Bottom Mount
- Acid and Alkali Proof Plastic Case
- 1/4" NPT Brass Mounting Stem
- Accuracy, Dry: + 3-2-3%
- Accuracy, Filled: + 1.5%
- Bronze Bourdon Tube

PART NO.	PRESSURE RANGE	MOUNTING STEM
8.710-291.0	0-100 PSI	1/4" NPT Brass
8.710-293.0	0-200 PSI	1/4" NPT Brass
8.710-294.0	0-300 PSI	1/4" NPT Brass
8.710-295.0	0-1000 PSI	1/4" NPT Brass
8.710-296.0	0-2000 PSI	1/4" NPT Brass
8.710-297.0	0-3000 PSI	1/4" NPT Brass
8.710-299.0	0-5000 PSI	1/4" NPT Brass

**PRESSURE REGULATOR, WATER 2-WAY**

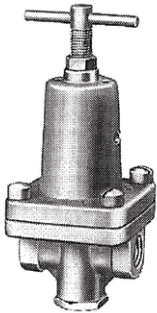

- PSI: 10 - 125
- 3/8" Valve
- Lowers city water pressure for better machine performance

PART NO.	DESCRIPTION	PSI
8.707-248.0	Pressure Regulator	10-125

**PRESSURE GAUGES - VACUUM - STAINLESS-STEEL**



- Black Lacquered Steel Case
- Bronze Bourdon Tube
- Dry Gauge
- 1/4" NPT Brass Mounting Stem
- Accuracy + 3-2-3%

PART NO.	DESCRIPTION
<b>2-1/2" BACK MOUNT WITH BRONZE INTERNALS</b>	
8.710-246.0	30Hg - 0 Vacuum Gauge
<b>MOUNTING HARDWARE FOR BACK MOUNT GAUGES</b>	
8.710-223.0	U-Bracket, Mounting
8.710-228.0	3-Hole Flange, Mounting

**PRESSURE GAUGES - STAINLESS-STEEL**



- AISI 304 Stainless-Steel Case
- Bronze Bourdon Tube
- 99.5% Pure Glycerin Filled
- PSI and Bar Dual Scale
- 1/4" NPT Brass Mounting Stem
- Convex Magnifying Lens for Easy Readings
- Steel Needle and Peg
- Accuracy + 1.5%

PART NO.	PRESSURE RANGE	MOUNTING STEM
<b>2-1/2" BOTTOM MOUNT WITH BRONZE INTERNALS</b>		
8.710-270.0	0-100 PSI	1/4" NPT Brass
8.710-272.0	0-200 PSI	1/4" NPT Brass
8.710-273.0	0-300 PSI	1/4" NPT Brass
8.710-276.0	0-500 PSI	1/4" NPT Brass
8.710-278.0	0-1000 PSI	1/4" NPT Brass
8.710-280.0	0-2000 PSI	1/4" NPT Brass
8.710-281.0	0-3000 PSI	1/4" NPT Brass
8.710-283.0	0-4000 PSI	1/4" NPT Brass
9.804-017.0	0-5000 PSI	1/4" NPT Brass
8.710-286.0	0-6000 PSI	1/4" NPT Brass
9.804-001.0	0-10,000 PSI	1/4" NPT Brass
<b>2-1/2" BACK MOUNT WITH BRONZE INTERNALS</b>		
8.710-250.0	0-100 PSI	1/4" NPT Brass
8.710-254.0	0-500 PSI	1/4" NPT Brass
8.710-256.0	0-1000 PSI	1/4" NPT Brass
8.710-257.0	0-2000 PSI	1/4" NPT Brass
8.710-258.0	0-3000 PSI	1/4" NPT Brass
8.710-259.0	0-4000 PSI	1/4" NPT Brass
8.712-149.0	0-5000 PSI	1/4" NPT Brass
8.712-150.0	0-6000 PSI	1/4" NPT Brass
8.710-262.0	0-6000 PSI	1/4" NPT Brass
9.804-013.0	0-10,000 PSI	1/4" NPT Brass
<b>MOUNTING HARDWARE FOR BACK MOUNT GAUGES</b>		
8.710-223.0	U-Bracket, Mounting	1/4" NPT Brass
8.710-228.0	3-Hole Flange, Mounting	1/4" NPT Brass



## PRESSURE GAUGES / TEMPERATURE TEST SET



Convenient test set provides both pressure and temperature check with one easy quick coupled connection at outlet of unloader or coil.



- Test Set 5000  
500°F Thermometer  
5000 PSI Pressure Gauge for Systems up to 2000 PSI
- Test Set 10,000  
10,000 PSI Pressure Gauge for Systems up to 5000 PSI

PART NO.	DESCRIPTION
8.904-559.0	Test Set 5000 (0-2500 PSI Systems)
8.904-558.0	Test Set 10,000 (0-5000 PSI Systems)

## THROTTLE CONTROL - SPEEDMASTER



Stop overworking the engine and pump during bypass. Decelerator reduces engine speed when pump head pressure drops below 215 PSI, reduces flow during bypass, slows recirculation heat build-up.



- PSI: 3500
- Temperature: 300°F
- A Major System Saver for Gas Engine Units
- Machined-Brass Body
- Stainless-Steel Gland Components
- 1/4" Male Connect
- Viton Seals
- 42" Lined and Covered Control Cable
- Engine Speeds Infinitely Adjustable for "Fine Tuned" System Performance

PART NO.	DESCRIPTION
8.903-840.0	Throttle Control

## VOLTMETERS



- Designated for OEM or Replacement
- Accuracy to + 5%
- Metal Case
- Rugged and Weather-Resistant
- Bright Stainless Bezel
- Utilize as Constant Monitor or as Test Instruments
- Fits 2-1/16" Mounting Hole

PART NO.	DESCRIPTION
8.712-159.0	Voltmeter 120V

## TEMPERATURE GAUGE



Dial thermometers.



- 3" Diameter Dial - Stainless-Steel Case
- Shatter-Resistant Polycarbonate Lens
- Stainless-Steel Stem (2.5")
- 1/2" MPT Connector
- Accuracy to within 3% of Dial Range (50-500+ 6.8°F)

PART NO.	DESCRIPTION
8.712-488.0*	Temp Gauge +50° to 500°F

\*"Thermwell" to be used with dial thermometers in systems over 300 PSI. For best results, fill Thermwell with liquid silicon or glycol to increase sensitivity and accuracy of readings.

## TEMPERATURE GAUGE - THERMWELL

For use with above temperature gauge.



- PSI: 2000 Collapse Protection
- 1.75" Immersion Length
- Stainless-Steel, 3/4" MPT x 1/2" FPT

PART NO.	DESCRIPTION
8.712-489.0	Thermwell for 8.712-488.0

## HOUR METERS FOR GASOLINE ENGINES



- Elapsed Time
- No Battery Required
- Digital Quartz Accuracy (+ .02%)
- Extremely Rugged and Tamperproof
- Sealed from Dirt and Moisture
- Requires 2" Panel Cutout

PART NO.	DESCRIPTION
8.749-183.0	EL 5-80V AC/DC 50/60 Hz
8.749-316.0	EL 24-277 AC/DC 50/60 Hz
9.802-283.0	24-240V AC - Rectangle
8.904-540.0	Tach/Hour 12V DC with Magnet Tool

**BRIGGS & STRATTON ENGINES - GASOLINE**

Briggs & Stratton's top-of-the-line engines have proven performance in the pressure washer industry. They contain the power to complete any job faster and easier with less wear and tear on major engine components.



- Easy, Quick-Starting
- Super Quiet Muffler
- State-of-the-Art Carburetion System
- Large Fuel Tank
- OilGaurd® Low-Oil Shutdown

PART NO.	HP	SHAFT DIA	START	CHARGE RATE	FUEL TANK	MODEL NO.
8.754-819.0	18	1"	Electric	20 Amp	N/A	Vanguard
8.715-067.0	21	1"	Electric	N/A	N/A	Vanguard

Note: Mufflers for the above engine are sold separately. See Briggs & Stratton Engine Parts section below.



OHV Vanguard

- 30% quieter muffler than competition
- Cast / Sintered Iron Sleeve
- OilGaurd® Low-Oil Shutdown

PART NO.	HP	SHAFT DIA	START	CHARGE RATE	FUEL TANK	MODEL NO.
8.709-887.0	11	1"	Recoil	N/A	2 Gal	Vanguard

**BRIGGS & STRATTON ENGINE PARTS**

Genuine Briggs & Stratton replacement parts are available. Please provide engine model / type / code to ensure proper fit of replacement parts. All are authorized manufacturer replacement parts.



8.701-826.0



8.701-823.0



8.701-820.0

PART NO.	DESCRIPTION
8.701-826.0	Briggs 16/18 HP Vanguard, Oil Filter
8.701-820.0	Briggs 5 HP Industrial, Air Filter
8.701-821.0	Briggs 8 or 11 HP IC, Air Filter
8.701-823.0	Briggs 16/18 HP Vanguard, Air Filter
8.718-021.0	Sparkplug, Vanguard, RC12YC

**HONDA ENGINE PARTS**

Original Honda replacement parts from the factory. Filters are a great add-on to every service order. All are authorized manufacturer replacement parts.



8.701-764.0



8.701-830.0



8.701-782.0



8.701-783.0

PART NO.	DESCRIPTION
8.701-830.0	Honda 18/20 HP, Oil Filter
8.701-764.0	Honda GX160, Air Filter
8.701-780.0	Honda GX240/270, Air Filter
8.701-781.0	Honda GX340, Air Filter
8.701-782.0	Honda GX610/620, Air Filter (old style)
8.701-783.0	Honda GX610/620, Air Filter (new style)
8.718-117.0	Honda GX All, Sparkplug

**ENGINES - KOHLER LOMBARDINI - DIESEL**

Kohler Lombardini water cooled diesel engines provide superior power and quiet operation.



- Diesel Powered
- Water Cooled

PART NO.	HP	SHAFT DIA	START	CHARGE RATE	FUEL TANK	MODEL NO.
8.753-906.0	26.8	1-1/2"	Electric	N/A	No	LDW1003, Water Cooled

### ENGINE PARTS - KOHLER LOMBARDINI

Factory direct Kohler parts. All are authorized manufacturer replacement parts.



8.717-912.0

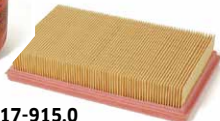

8.717-915.0

PART NO.	DESCRIPTION	ENGINE MODEL
8.717-912.0	Oil Filter	LDW602/903/1003
8.717-915.0	Air Filter	LDW602/903/10003
8.717-909.0	Fuel Filter	LDW602/903/1003

### STARTER SOLENOID - 12V DC

Universal type used on many lawn and garden tractors and mowers.



- Double Terminal - 5/16", 24 Studs
- Same as used on 16 HP B & S Vanguard Engines
- Rated for Intermittent Duty (i.e. for starting small gasoline engines)

### VOLTAGE REGULATOR - HEAVY-DUTY 15V



- Eliminates need for battery on 12 volt recoil hot water washers

PART NO.	DESCRIPTION
8.701-691.0	12V DC Starter

PART NO.	DESCRIPTION
9.802-531.0	Regulator, Voltage 15 Volts

### KEYED IGNITION SWITCH - 12V DC



- Universal Style / 5 Pole
- Off / On Start (Spring Back to On)
- Panel Nut and Star-Lock Washer
- Two keys included
- Has two auxiliary circuits
- Universal - used for small engine controls on many lawn and garden tractors, mowers

PART NO.	DESCRIPTION
8.701-689.0	Keyed Ignition Switch, 5 Pole
8.701-690.0	Keyed Ignition Switch, 6 Pole

### BALDOR MOTORS - C-FACE OPEN DRIP PROOF (ODP)

Built to "industrial" specifications.



PART NO.	MOTOR HP	RPM	SHAFT DIA	BOLT CIRCLE	FRAME C-FACE	FULL LOAD AMPS	VOLTAGE	MODEL
<b>SINGLE-PHASE MOTORS</b>								
9.107-929.0	2.0	1725	5/8"		56C	16.4/8.2	115/230	EPCL1322M
8.709-754.0	3.0	3450	5/8"	5-7/8"	56C	13.7/12.5	208/230	35K316Y771A4
8.709-723.0	3.0	1725	5/8"	5-7/8"	184CZ	32/16	115/230	36G309-2761
8.709-727.0	4.0	1725	5/8"	5-7/8"	182CZ	17.5/16	208/230	36G551X401G1
8.709-728.0	4.0	3450	5/8"	5-7/8"	56C	38/21/19	115/208/230	35K316S276G1
8.709-730.0	5.0	1725	1-1/8"	7-1/4"	184TC	25/23	208/230	CL1410TM
8.709-731.0*	5.0	3450	5/8"	5-7/8"	56HCY	24/23	208/230	PCL1327M
8.709-733.0	6.0	1725	1-1/8"	7-1/4"	184TCZ	26	230	36G601X288G1
8.709-734.0	7.5	1725	1-1/8"	7-1/4"	215C	36/33	208/230	37N007X177G1

\* SPECIAL MOTOR/ODTF- OPEN DRIP PROOF TANDEM FAN

**BALDOR MOTORS - OPEN DRIP PROOF (ODP)**

Industrial-grade motors built specifically to meet or exceed the demands for the pressure washer industry.



■ The Industry Standard

■ U.L. Listed



**1 Phase, 56 Frame**



**1 Phase, 184T Frame**



**3 Phase, 184T Frame**

PART NO.	MOTOR HP	VOLTAGE	RPM	SHAFT DIA	FRAME	FULL LOAD AMPS	MODEL
<b>SINGLE-PHASE MOTORS</b>							
9.804-516.0	1.5	115V	1725	5/8"	56C	13.6	35R735R770G1
8.754-709.0	2.0	115V	1750	5/8"	56C	16.4	35E3197L171G1
8.754-710.0	2.0	115/230V	3470	5/8"	56C	15.6/7.8	35U075L138G1
9.107-929.0	2.0	115/230V	1725	5/8"	56C	16.4/8.2	EPCL1322M
8.715-158.0	2.3	115V	1750	5/8"	56C	18	35Q899R328G1
8.709-751.0	3.0	115/230V	1725	1-1/8"	184T	32/16	L1408TM
8.715-090.0	3.0	208/230V	1725	5/8"	56HC	12.5	35M895T356
8.715-144.0*	5.0	200V	3450	3/4"	56CZ	24.5	35V142R510G1
8.715-146.0	5.0	208/230V	3450	3/4"	56CZ		35L358S214G1
8.709-759.0*	5.0	208/230V	3450	5/8"	56/56H	23/24	PL1327M
8.709-757.0*	5.0	208/230V	1725	1-1/8"	184T	25/23	L1410TM
8.715-091.0	5.0	230V	1725	7/8"	184TCZ	23	36L306W903G1
8.715-142.0	5.0	230V	1725	1-1/8"	182TZ	23	36J800X811
9.802-337.0	6.2	200V	1725	1-1/8"	184TZ	30.7	36J468Y852
9.802-336.0**	6.2	230V	1725	1-1/8"	184TZ	26	36K907T466
8.715-102.0	7.5	230V	1725	1-3/8"	215TZ	31	37H404W885G1
8.715-163.0	8.2	208V	1740	1-3/8"	215T	36.5	37H847Y711G1
8.715-165.0	8.2	230V	1740	1-3/8"	215T	34.5	37H847Y712
8.715-168.0	8.2	230V	3450	1-1/8"	184T	32.8	36E002Y277G1
8.725-973.0	8.2	230V	1740	1-3/8"	215T	34.5	37L276Y712G1
<b>THREE-PHASE MOTORS</b>							
8.751-009.0**	5.0	575V	1750	1-1/8"	184T	5.3	EM3218T-5
8.751-004.0**	6.2	208-230/460	1750	1-1/8"	184T	17.6-17.4/8.7	36G548S590G1
8.751-014.0**	7.5	208-230/460	1770	1-3/8"	213T	20.4-19.4/9.7	EM3311T
8.751-010.0**	7.5	575V	1770	1-3/8"	213T	7.8	EM3311T-5
8.750-999.0**	8.2	208-230/460	1770	1-3/8"	215T	22.2/11.1	37F614S938G1
8.751-005.0**	8.2	575V	3450	1-1/8"	184T	7.4	36G548S515G1
8.751-011.0**	10.0	575V	1770	1-3/8"	215T	10.0	EM3313T-5
8.751-008.0**	20.0	575V	1765	1-5/8"	256T	19.1	EM2515T-5

Note: Amp draw ratings require adequate wire size and full voltage to apply. Full load Amp ratings apply only when full rated.  
 \* SPECIAL MOTOR/ODTF- OPEN DRIP PROOF TANDEM FAN \*\* OPSB = Additional slotted bands to vent the heat.

**MOTORS - TOTALLY ENCLOSED FAN COOLED (TEFC)**

Featuring heavy-gauge steel frames, ball bearings, welded base and "snap-action" starting for reliability. Built to industrial specifications.



PART NO.	MOTOR HP	RPM	SHAFT DIA	BOLT CIRCLE	FRAME / C-FACE	FULL LOAD AMPS	VOLTAGE	MODEL
<b>SINGLE-PHASE MOTORS</b>								
8.709-767.0	1.5	1725	5/8"	5-7/8"	56C	12/6	115/230	PCL3514M
8.723-881.0	2.0	1725	5/8"		56C	17.6/8.8	115/230	35W249T988G1
8.709-774.0	2.0	3450	5/8"	5-7/8"	56C	17.6/8.8	115/230	PCL3515M
8.709-779.0	3.0	3450	5/8"	5-7/8"	56C	13.7/12.5	208/230	PCL3519M
8.709-784.0	5.0	1725	1-1/8"	7-1/4"	184TC	23	230	CL3612TM
8.709-737.0	7.5	1725	1-1/8"	7-1/4"	215C	34.1/30.8	208/230	37H209T032
8.709-793.0	10.0	1740	1-3/8"		215T	38	230	L3712T
<b>THREE-PHASE MOTORS</b>								
8.751-318.0	5.0	1750	1-1/8"	7-1/4"	184TC	13.9-13.4/6.7	208-230/460	CEM3615T
8.751-016.0	10.0	1770	1-3/8"		215T	25.4-24/12	208-230/460	EM3714T

**MOTORS - A.O. SMITH - PRESSURE WASHER - OPEN DRIP PROOF (ODP)**

Excellent power efficiency.



PART NO.	MOTOR HP	RPM	SHAFT DIA	BOLT CIRCLE	FRAME / C-FACE	FULL LOAD AMPS	VOLTAGE	MODEL
<b>SINGLE-PHASE MOTORS</b>								
8.709-808.0	6.0	3600	7/8"	5-7/8"	56Y	22.0	208/230	B869

**REFERENCE / CALCULATION GUIDE**

Conversion Factors	Horsepower (HP) Equations	QUESTIONS AND ANSWERS
1 inch = 25.4 mm	HP = $\frac{\text{GPM} \times \text{PSI}}{1460}$	How fast do I turn my pump to give me a desired GPM?
1 cm = 0.394 inch	PSI = $\frac{\text{HP} \times 1460}{\text{GPM}}$	Required RPM = $\frac{(\text{Desired GPM} \times \text{Rate RPM})}{\text{Rated GPM}}$
1 gal H2O = 8.33 lbs.	GPM = $\frac{\text{HP} \times 1460}{\text{PSI}}$	How fast do I turn my pump to give me a desired GPM?
1 oz. = 23.35 gram		Pump Pulley Diameter = $\frac{\text{Motor Pulley Diameter} \times \text{Motor RPM}}{\text{Pump RPM}}$
1 gal = 3.79 liter		
1 liter = 0.2642 gal		

**MOTORS - WEG - PRESSURE WASHER**

Built to industrial specifications.



- Rolled Steel Platform



PART NO.	MOTOR HP	SHAFT DIA	FRAME	FULL LOAD AMPS	VOLTAGE	MODEL
<b>MOTORS- WEG-PRESSURE WASHER- OPEN DRIP PROOF (ODP)</b>						
<b>THREE-PHASE MOTORS</b>						
8.756-425.0	5.0	1-1/8"	182/4T	14.0-12.7/6.33	190/380/208-230/460	005180T3E184T-S
8.755-598.0	5.0	1-1/8"	182/4T	14.6	200	005180T3P184T-S
8.755-604.0	7.5	1-3/8"	213/5T	20.5-18.5/9.25	190/380/208-230/460	007180T3E213T-S
8.755-606.0	7.5	1-3/8"	213/5T	21.0	200	007180T3P213T-S
8.755-599.0	10.0	1-3/8"	213/5T	28.5	200	010180T3P215T-S
8.755-605.0	10.0	1-3/8"	213/5T	27.4-24.8/12.4	190/380/208-230/460	010180T3E215T-S
8.755-600.0	15.0	1-5/8"	254/6T	42.2	200	015180T3P254T-S
8.756-429.0	15.0	1-5/8"	254/6T	41.1-37.2/18.6	190/380/208-230/460	015180T3E254T-S
8.755-601.0	20.0	1-5/8"	254/6T	56.8	200	020180T3P256T-S
8.756-431.0	20.0	1-5/8"	254/6T	55.3-50.0/25.0	208-230/460	020180T3E256T-S
<b>MOTORS- WEG-PRESSURE WASHER- TOTALLY ENCLOSED FAN COOLED (TEFC)</b>						
<b>SINGLE-PHASE MOTORS</b>						
8.759-045.0	2.0	5/8"	56C	16.2/8.12	115/230	1725
8.759-047.0	5.0	1 1/8"	182/4T	22.7	200	1755
8.759-048.0	5.0	1 1/8"	182/4T	20.4	230	1755
8.759-053.0	6.2	1 1/8"	182/4TZ	27.7	200	1750
8.759-054.0	6.2	1 1/8"	182/4TZ	24.3	230	1750
8.759-057.0	7.5	1 1/8"	213/5TZ	33.1	200	1745
<b>MOTORS- WEG-PRESSURE WASHER- TOTALLY ENCLOSED FAN COOLED (TEFC)</b>						
<b>THREE-PHASE MOTORS</b>						
8.759-059.0	5.0	1 1/8"	182/4T	14.9	200	1750
8.759-051.0	5.0	1 1/8"	182/4T	13.0/6.49	230/460	1750
8.759-052.0	5.0	1 1/8"	182/4T	5.19	575	1750
8.759-070.0	10.0	1 1/8"	213/5T	28.1	200	1760
8.759-071.0	10.0	1 1/8"	213/5T	24.4/12.2 A	230/460	1760
8.759-072.0	10.0	1 1/8"	213/5T	9.76	575	1760
8.759-073.0	15.0	1 3/8"	254/6T	41.9	200	1770
8.759-074.0	15.0	1 3/8"	254/6T	36.4/18.2 A	230/460	1770
8.759-075.0	15.0	1 3/8"	254/6T	14.6	575	1770
8.759-076.0	20.0	1 3/8"	254/6T	56.8	200	1765
8.759-077.0	20.0	1 3/8"	254/6T	49.4/24.7 A	230/460	1765
8.759-078.0	20.0	1 3/8"	254/6T	19.8	575	1765

**SMALL ENGINE TEST EQUIPMENT**



**SPARK TESTER**

- Connects between plug and plug wire
- Totally Contained Spark
- Engine will run with tester attached
- Neon test light verifies proper ignition
- Handy tool allow safe, easy visual inspection of ignition output



**COMPRESSION TESTER**

- Designed for small engines
- 2-1/2" dial reads up to 300 PSI
- 12" flexible hose to reach spark plug holes
- Adapters for 14 mm and 18 mm spark plug holes
- Built-in pressure holding / release valves



**WIRELESS TACHOMETER**

- Terrific service aid for 1-cylinder engines
- Just hold built-in antenna near spark plug
- Two scales: 0-5,000 RPM or 0-15,000 RPM
- Solid-State Electronics
- Requires 9V Battery (not included)
- Excellent for setting GPM on pressure washers; accuracy within 2% of full scale

PART NO.	DESCRIPTION
8.701-680.0	Spark Tester
8.701-682.0	Compression Tester
8.701-681.0	Wireless Tach

**COUPLERS SECTIONS - BROWNING / LOVEJOY**

Listed as individual coupler sections (half) to allow flexibility in design. For complete coupler select: Bore size for motor + Bore size for pump + Spider = Complete Coupler.

Please Note: Select halves from same series as listed in groups below. (e.g. All "090/095", "099/100")



PART NO.	DESCRIPTION	BORE
<b>090/095 SERIES: UP TO 3 HP ELECTRIC OR 4 HP GAS</b>		
8.709-620.0	Coupler Half	24 mm
8.709-640.0	Coupler Half	5/8" (090)
8.709-634.0	Coupler Half	3/4" (090)
8.709-639.0	Buna Spider for 090 (STD)	
<b>099/100 SERIES: UP TO 5-7 1/2 HP ELECTRIC OR 5-13 HP GAS</b>		
8.709-626.0	Coupler Half	3/4" (100)
8.709-625.0	Coupler Half	20 mm (100)
8.709-627.0	Coupler Half	24 mm (099)
8.709-628.0	Coupler Half	24 mm (100)
8.709-629.0	Coupler Half	1" (100)
8.709-632.0	Coupler Half	1-1/8" (100)
8.709-637.0	Coupler Half	1-3/8" (100)
8.709-633.0	Buna Spider for 099/100 (STD)	

**PULLEY BUSHINGS**

Split taper "H"



- Split Taper, Malleable Iron
- Keyed to Both Shaft and Hub
- Highest Torque Carrying Capacity

PART NO.	SIZE
<b>MOTOR / ENGINE BUSHINGS</b>	
9.802-397.0	H X 5/8"
9.803-897.0	H X 3/4"
8.715-633.0	H X 7/8"
9.802-399.0	H X 1"
9.802-400.0	H X 1-1/8"
9.802-401.0	H X 1-3/8"
8.715-638.0	H X 1-3/8" - 6B, Spline
<b>PUMP BUSHINGS</b>	
8.711-118.0	H X 20 mm
8.711-119.0	H X 22 mm
9.802-402.0	H X 24 mm
9.802-403.0	H X 25 mm
8.715-646.0	H X 30 mm
8.711-124.0	H X 32 mm
8.711-125.0	H X 35 mm

**PULLEYS**

Fits Interpump, General and Admiral XLS, XDS Series pumps, plus XD3040, XD3047, XD3047, XD3055 and XD3065.



- Double Groove
- 24 mm Bore

- 2 x A Groove

PART NO.	OD
8.711-115.0	4.0"
8.711-116.0	5.5"
8.711-117.0	6.3"

**V-BELTS - SUPER "GRIPNOTCH"**



- Full Line of Belts
- "V"-notched for longer life and better performance

PART NO.	SIZE
8.715-669.0	AX26
8.715-671.0	AX28
8.715-672.0	AX29
8.715-673.0	AX30
9.804-026.0	AX31
9.803-896.0	AX33
9.802-407.0	AX34
9.803-683.0	AX35
9.802-408.0	AX36
9.802-409.0	AX37
9.802-410.0	AX38
9.803-543.0	AX39
9.804-005.0	AX40
8.715-682.0	AX41
9.802-411.0	AX42
8.715-684.0	AX46
9.715-685.0	AX43
9.802-412.0	BX22
9.803-626.0	BX30
9.802-413.0	BX32
9.802-414.0	BX34

PART NO.	SIZE
9.802-415.0	BX35
9.802-416.0	BX36
8.715-698.0	BX37
8.710-745.0	BX38
9.802-418.0	BX39
8.715-701.0	BX40
8.715-702.0	BX41
9.802-419.0	BX42
9.802-420.0	BX43
9.802-421.0	BX44
8.710-756.0	BX45
8.715-706.0	BX46
8.715-707.0	BX47
8.715-708.0	BX48
8.710-761.0	BX49
8.715-709.0	BX50
8.715-710.0	BX51
8.715-712.0	BX54
8.710-766.0	BX56
8.715-711.0	BX52
8.715-713.0	BX68



## Pulley-Sheaves

High-quality, cast-iron pulleys, Cast design. All sizes available.



AK Pulley



2AK Pulley



BK Pulley



2BK Pulley



3TB Pulley

PART NO.	SIZE	OD
8.715-517.0	AK21*	2.10"
8.715-519.0	AK23*	2.30"
9.802-368.0	AK25*	2.50"
9.804-028.0	AK28*	2.80"
8.715-527.0	AK32H	3.25"
8.715-530.0	AK34H	3.45"
9.803-898.0	AK39H	3.75"
9.802-369.0	AK74H	7.25"
8.715-538.0	AK84H	8.25"
8.715-539.0	AK89H	8.75"
9.803-298.0	2AK30H	3.05"
9.802-371.0	2AK32H	3.25"
9.804-047.0	2AK34H	3.45"
8.715-546.0	2AK44H	4.25"
8.715-547.0	2AK46H	4.60"
8.715-548.0	2AK49H	4.75"
8.715-549.0	2AK51H	4.95"
9.802-372.0	2AK54H	5.25"
8.715-555.0	2AK64H	6.25"
9.802-374.0	2AK74H	7.25"
9.802-375.0	2AK84H	8.25"
9.803-548.0	2AK94H	9.25"
8.715-560.0	BK30H	3.30"
9.802-377.0	BK32H	3.35"
9.802-378.0	BK34H	3.55"
9.802-379.0	BK36H	3.75"
8.715-566.0	BK40H	3.95"
8.710-819.0	BK45H	4.25"
8.710-823.0	BK47K	4.45"
8.710-831.0	BK52H	4.95"

PART NO.	SIZE	OD
8.710-837.0	BK60H	5.75"
8.715-568.0	BK65H	6.25"
8.715-570.0	BK70H	6.75"
8.715-571.0	BK75H	7.25"
9.802-380.0	BK80H	7.75"
8.715-573.0	BK85H	8.25"
8.710-858.0	BK100H	9.75"
8.715-574.0	BK90H	8.75"
8.715-576.0	2BK32H	3.35"
9.802-382.0	2BK34H	3.55"
9.802-383.0	2BK36H	3.76"
9.802-384.0	2BK40H	3.95"
9.802-385.0	2BK45H	4.25"
8.715-582.0	2BK47H	4.45"
8.715-583.0	2BK50H	4.75"
9.802-386.0	2BK52H	4.95"
8.715-585..0	2BK55H	5.25"
9.803-299.0	2BK57H	5.45"
9.802-387.0	2BK60H	5.75"
8.715-588.0	2BK62H	5.95"
9.804-060.0	2BK65H	6.25"
9.802-388.0	2BK67H	6.45"
8.715-591.0	2BK70H	6.75"
9.802-389.0	2BK80H	7.75"
8.715-593.0	2BK90H	8.75"
9.802-391.0	2BK100H	9.75"
8.715-598.0	2TB40	4.35"
9.802-392.0	3TB34	3.75"
9.802-394.0	3TB40	4.35"

**BURNERS - BECKETT - 115V / 230V**

Ergonomically designed to be the most comfortable gun on the market.



- .4 to 3 GPH firing rate
- 6-1/4" Blower Fan, 115V and 230V
- 3,450 RPM Pump / Blower Motor
- Solid-State Ignition
- Beckett "CleanCut" Fuel Pump with Oil Valve
- Air Tube: 2-3/4"
- UL-Recognized

PART NO.	DESCRIPTION
8.709-325.0	Beckett AFG 115
8.709-326.0	Beckett AFG 230

**BURNER CHART - BECKETT**



BURNER			MOTOR		BLOWER WHEEL		IGNITOR ASSEMBLY	
PART NO.	DESCRIPTION	BECKET NO.	PART NO.	BECKET NO.	PART NO.	BECKET NO.	PART NO.	BECKET NO.
8.709-326.0	AFG, 240V 3"	VMG202	8.750-518.0	22825U	9.802-649.0	2999U	8.751-780.0	5199701U
8.709-325.0	AFG, 120V AC	VMG902	9.802-642.0	21805U	9.802-649.0	2999U	9.802-647.0	51771U
8.709-327.0	ADC, 13.5V DC - without ICB*	VMG504	9.802-638.0	52145U	9.802-636.0	2999AU	8.751-784.0	5218301U
8.709-328.0	ADC, 13.5V DC - with ICB*	VMG505	9.802-638.0	52145U	9.802-636.0	2999AU	8.751-784.0	5218301U
8.717-071.0	SM, 120V	HO1501	8.701-090.0	2364U	9.803-057.0	2383U	9.803-060.0	51824U
8.717-090.0	SM, 240V	HO1301	8.701-093.0	21344U	9.803-057.0	2383U	8.751.781.0	5199702U

\*Ignition Control Board

BURNER			FUEL PUMP		SOLENOID WITH CORD SET		TUNE UP KIT	
PART NO.	DESCRIPTION	BECKET NO.	PART NO.	BECKET NO.	PART NO.	BECKET NO.	PART NO.	BECKET NO.
8.709-326.0	AFG, 240V AC	VMG202	9.802-644.0	2184403U	8.900-082.0	N/A	8.723-715.0	578730
8.709-325.0	AFG, 120V AC	VMG902	9.802-645.0	2184405U	8.900-081.0	N/A	8.723-715.0	578730
8.709-327.0	ADC, 13.5V DC - without ICB*	VMG504	9.802-562.0	2184402U	8.900-080.0	N/A	8.723-715.0	578730
8.709-328.0	ADC, 13.5V DC - with ICB*	VMG505	9.802-562.0	2184402U	8.900-080.0	N/A	8.723-715.0	578730
8.717-071.0	SM, 120V	HO1501	9.802-645.0	2184405U	8.900-081.0	N/A	8.723-715.0	578730
8.717-090.0	SM, 240V	HO1301	9.802-644.0	2184403U	8.900-082.0	N/A	8.723-715.0	578730

\*Ignition Control Board

**BURNERS - BECKETT 14V DC**



- 14V, Solid-State Ignition
- 1/6 HP
- 3,450 RPM
- 4-1/4" Fan
- Max Rate 2.5 GPH
- Beckett "CleanCut" Fuel Pump with Oil Valve

PART NO.	DESCRIPTION	OIL VALVE	ELECTRIC EYE	MOTOR RPM
8.709-327.0	Beckett, 13.5V, VMG504	Yes	-	3450
8.709-328.0	Beckett, 13.5V, VMG505	Yes	Yes	3450

Note: Proper operation requires an engine with 16+ Amp alternator and deep-cycle battery on nightly, overnight recharge

**FLEX COUPLINGS - BECKETT**



PART NO.	BECKETT NO.	DESCRIPTION
9.802-648.0	2454	A/AF/AFG/NX
9.803-058.0	2433	5/16" X 1/2" SR/SF/SM/CF
9.802-637.0	2140501U	12V DC ADC

**BURNER PARTS - BECKETT - MISC REPAIR**



PART NO.	BECKETT NO.	DESCRIPTION
9.802-651.0	31332	Mntg Flange Gasket, 323005
8.701-059.0	578726	Electrode Insltr Assy,- SDC
8.701-063.0	5432	Flange, Adj, with Gasket (All)
8.723-912.0	5850	Flange, Split, Adj, with Gasket
8.701-070.0	31653	Gasket, Universal Flange (Replaces 3616)
9.802-653.0	31802	Gasket, Mtg Flange, 4 slot Square (Replaces 3416)
8.701-085.0	5717 (51400)	Knurled Nut Kit ADC
8.701-134.0	51304	Gasket Kit, Xfmr Mntg -A/AF/AFG/NX
8.701-132.0	31404	Clamp, Xfxr Mntg Plate
9.802-676.0	7006U	Cad Cell Eye with leads-A/AF/AFG/NX/SR/SF
8.701-137.0	7556A0000U (7556A)	Burner Control, 12V DC
8.701-133.0	3245	Spring, Xfmr Contact
8.701-106.0	AF90	9" Air Tube Assy without Head, Includes 51400
8.701-074.0	5151501	Air Band, 8 Slot- A/AF/AFG

**BURNER PARTS - BECKETT - ELECTRODE / INSULATOR ASSEMBLY**



PART NO.	BECKETT NO.	DESCRIPTION
9.802-668.0	5780	Electrode Insulator Kit: AF/AFG/AR/SF/SR
8.717-978.0	578728	Electrode Insulator Assembly EA17305H-ADC
9.802-669.0	578711	Electrode Insulator Assembly EA13602J withContact
9.802-670.0	578727	Electrode Insulator Assembly EA15602J
8.751-342.0		Electrode Ignition AC/DC

**BURNER CONTROLLER AND CONTRACTOR TOOL - GENISYS™**

Advanced burner control, 120V AC primary safety control for residential and light commercial oil burners.



PART NO.	BECKETT NO.	DESCRIPTION
8.751-335.0	7505A	Genisys Controller
8.726-018.0	52082U	Genisys Contractor Tool

**BURNERS - WAYNE**



**115V AND 220V WAYNE BURNER**

- 75 to 3 GPH Firing Rates
- Solid-State Ignition (Low Amp)
- 3,450 RPM Pump / Blower Motor
- "A"-Type Suntec Fuel Pump
- UL-Recognized
- High-volume 6-1/4" blower on 220V unit, 5-3/16" blower on 110V unit
- 3-3/4" air tube with adjustable flange for maximum versatility

**12V WAYNE BURNER CHART**

- 12V Solid-State Ignitor
- 3,450 RPM Fuel Pump
- .5 to 2.75 GPH Capacity with Oil Valve



PART NO.	DESCRIPTON
<b>8.709-317.0</b>	115V AC Burner with Oil Valve - EHASR
<b>8.709-318.0</b>	230V AC Burner with Oil Valve - EHASR
<b>8.709-319.0*</b>	12V DC Burner with Oil Valve - MSRDC

\*Proper operation requires an engine with 16+ Amp alternator and deep-cycle battery on nightly, overnight recharge

**BURNER CHART - WAYNE**



PART NO.	DESCRIPTON	IGNITOR	TRANSFORMER	MOTOR
<b>8.709-317.0</b>	Wayne 115V	8.700-802.0 079111	8.700-804.0 079115	8.701-095.0 079612
<b>8.709-318.0</b>	Wayne 220V	N/A N/A	8.700-809.0 079123	8.701-094.0 079611
<b>8.709-319.0</b>	Wayne 12V	8.700-807.0 079120 Includes	N/A N/A	8.700-739.0-FASCO 079021  8.750-715.0-MET to FASCO 079021X

Note: 8.700-721.0 - Coupling for 8.700-740.0 FASCO motor used on MET to FASCO converted burner  
 8.700-720.0 - Adapter Bushing to allow MET blower wheel to work with FASCO motor  
 8.700-740.0 - Conversion Kit, use MET to FASCO conversion kit if 12V burner motor cannot be identified.  
 The kit contains the following parts: 8.700-739.0 Motor, 8.700-720.0 Adapter Bushing, 8.700-682.0 Adapter Plate, 8.700-721.0, Coupling, 8.700-691.0 Screws (2), 8.700-104.0 Nuts

PART NO.	DESCRIPTON	BLOWER WHEEL	FUEL PUMP	SOLENOID VALVE	ELECTRODE ASSEMBLY
<b>8.709-317.0</b>	Wayne 115V	8.700-730.0 079005	8.700-749.0 079030	8.700-779.0 079062	8.700-770.0 079052
<b>8.709-318.0</b>	Wayne 220V	8.700-731.0 079006	8.700-749.0 079030	8.700-780.0 079063	8.700-770.0 079052
<b>8.709-319.0</b>	Wayne 12V	8.700-727.0-FASCO 079003  2.44"W x 2.53" T 5/16" Shaft 8.700-728.0 (079003A) MET 3.44" W x 4.25" T 1/2" Shaft	8.700-749.0 079030	8.700-782.0 079064	8.700-774.0 079056 with 8.700-721.0 coupling for converting from MET to FASCO

Note: 8.700-721.0 - Coupling for 8.700-740.0 FASCO motor used on MET to FASCO converted burner  
 8.700-720.0 - Adapter Bushing to allow MET blower wheel to work with FASCO motor  
 8.700-740.0 - Conversion Kit, use MET to FASCO conversion kit if 12V burner motor cannot be identified.  
 The kit contains the following parts: 8.700-739.0 Motor, 8.700-720.0 Adapter Bushing, 8.700-682.0 Adapter Plate, 8.700-721.0, Coupling, 8.700-691.0 Screws (2), 8.700-104.0 Nuts

## BLOWER WHEELS - WAYNE



PART NO.	WAYNE NO.	WIDTH X OD	SHAFT SIZE
8.700-730.0	20288-SER	3.44" X 5.25"	1/2"
8.700-731.0	21854-SER	4.00" X 6.25"	1/2"
8.700-726.0	20673-SER	3.12" x 4.25"	1/2"
8.700-727.0	101317-SER	2.44" X 4.53" (FASCO)	5/16"
8.700-728.0	21427-SER	3.44" X 4.25" (MET)	1/2"

## BURNER REPAIR PARTS / COMMON - BECKETT & WAYNE



Brass Elbow



Oil Line

PART NO.	DESCRIPTION
8.701-054.0	Oil Line, 6.5", Copper
9.802-667.0	Oil Line, 8", Copper
8.701-053.0	Oil Line, 9.5", Copper
8.700-784.0	Brass 90° Elbow 1/8" Flare, 1/8" MPT
8.700-785.0	Brass 90° Elbow 3/16" Flare, 1/8" MPT
8.700-738.0	Oil Pressure Gauge 0-200 PSI
8.700-768.0	(28737-1) Nozzle Adapter
8.705-063.0	Straight Thru Double Nipple 1/8" x 1/8"
8.700-777.0	Coupler End (J Pump 7/16")

## BURNER REPAIR PARTS - WAYNE



PART NO.	WAYNE NO.	DESCRIPTION
8.700-774.0	31156	Crown Burner Tune-up Kit
8.700-770.0	14733-001	Electrode Assembly (Pair)
8.700-743.0	12945	Buss Bar - G Shape
8.700-754.0	14344	Burner Gasket- 4" (E-Series)
8.700-692.0	12484	Universal Flange Gasket- 7 3/8" x 4 5/16"
8.700-735.0	20372	Burner Housing (E-Series)
8.700-736.0	2689-SER	Adj. Flange Kit with Gasket-Serv
8.700-776.0	13279	Shaft Coupler - 5/16"(Green) x 1/2" (Gray) - 4.33" long
8.700-733.0	13360	Transformer Clip Screw, 5/16"-15
8.700-734.0	13038	Transformer Hold Down Clip
8.700-729.0	2668-002	Outer Air Band (8 Hole)
8.700-732.0	2669-002	Inner Air Band (8 Hole)
8.700-714.0	31702-014	Gun Assy, F/307007
8.700-680.0	21913-SER	Nzl Adaper with Legs MSR / DC

**BURNER MOTORS**



48M 5.75" Diameter



48N 7.25" Diameter

PART NO.	CAPACITOR	RPM	HP	FLANGE	VOLTAGE	WAYNE / BECKETT
9.802-642.0	Y	3450	1/7	48M	115V	20627 / 21805U
8.750-518.0	Y	2850 / 3450	1/7	48M	220V	NA / Beckett PN#22825U
8.700-739.0		4500	1/5	48M	12V DC	21993-005 / N/A
9.802-638.0	Kit	3450	1/6	48M	13.5V	N/A / 52145U
8.701-090.0		3450	1/4	48N	115V	N/A / 2364U
8.701-091.0		3450	1/4	48N	12V	N/A / 52146U
8.701-093.0	Y	3450	1/4	48N	115/240V	N/A / 21344
8.701-094.0		3450	1/5	48N	240V	21328 / 21173U
8.701-095.0		3450	1/5	48N	115V	20554 / 2900U
8.700-740.0	Kit, 12V DC / MET to FASCO					
<b>UNIVERSAL</b>						
8.700-741.0		3450	1/7	48M	110-60 Hz	
8.700-744.0		3450	1/5	48N	110/240V	Capacitor Start

**BURNER TUNE UP KIT - BECKETT**

Fits all Beckett Burners with 3" or 3-5/8" air tube.



**KIT CONTAINS:**

- Four Beckett Electrodes
- Two Couplings
- One Fuel Line
- T-Gauge

PART NO.	DESCRIPTION
8.723-715.0	Beckett Burner Tune-up Kit

**BLOWER WHEELS - BECKETT**



PART NO.	DESCRIPTION	SHAFT SIZE
9.803-057.0	6-1/4" D x 3-7/16" W	1/2", SR/SF/SM
9.802-649.0	4-1/4" D x 2-1/2" W	1/2", AFG/ADC
9.802-636.0	4-1/4" D x 2-7/16" W	1/2" & 5/16", AFG/ADC

**FUEL CONDITIONER AND SOOT REMOVER**

Red Devil eliminates soot build-up.



- Easy to Use - just add to burner fuel
- Keeps burner at top efficiency
- 1 oz. Per 10 Gallons

PART NO.	DESCRIPTION
8.704-625.0	Pint (16 oz.)
8.704-626.0	Quart

**FUEL PUMP - BECKETT CLEAN CUT**

Simple design provides faster cleaning, more reliable cut-offs, and cut-ons. Cleaner operation - less soot. More reliable - fewer moving parts. Reduced motor load in start-up. Higher capacity - 4 GPH at 100 PSI.



- PSI: 100-200
- Factory Set PSI: 100
- Inlet Pressure PSI: 10
- Rated Speed: 3,600 RPM
- Includes built-in solenoid with cord set

PART NO.	DESCRIPTION
9.802-645.0	110V
9.802-644.0	220V
9.802-562.0	12V
9.802-646.0	Valve Stem Kit (21877U)

**SOOT PUMP**

Tool for measuring the soot number in the exhaust of HDS appliances.



PART NO.	DESCRIPTION
6.775-001.0	Soot pump

### BURNER IGNITORS - BECKETT



- Solid-State Technology
- 14,000V Spark
- Only .35 AMP @ 110V
- 1.7 lbs.

PART NO.	BECKETT PART NO	NO MOUNTING	VOLT
9.802-647.0	51771U	AFG/Lo Amp	120V
8.751-788.0	5218309U	ADC/ SDC	12V DC
8.751-785.0	517780	SDC w/Con BD	12V DC
9.803-060.0	51824U	SM/SF	120V
8.701-140.0	51779U	SDC w/o CB	12V DC

\*Complete with timer

### FUEL PUMPS & REPLACEMENT PARTS - SUNTEC



- Use with Single- or Dual-Line Systems
- Pressure Adjustment Valve

PART NO.	SUNTEC NO.	GPH	RPM	ROTATION
<b>STANDARD PUMPS</b>				
8.700-749.0	A2VA7116	3.0	3450	RH
8.700-789.0	A2VD-7119	3.0	3450	LH
8.700-756.0	A1YA7912	7.0	1725	RH
8.700-757.0	A2YA7916	7.0	3450	RH
8.700-748.0	A2RA7710	2.5		RH
<b>PUMPS WITH SOLENOID</b>				
8.754-705.0	OL35, 12/24V			
8.754-706.0	OL35, 120V	3.0		
8.754-707.0	OL35, 230V			
8.700-758.0	A2VA3106-N221R/ 12-24V	4.0	3450	RH
8.700-760.0	A2VA-3106-N721R / 230V	3.0	3450	RH
<b>PUMP REPLACEMENT PARTS</b>				
8.700-764.0	3715732 (A2VA 7116)	Pump Fuel Screen		
8.717-878.0	3715744 (A2AVA 7916)	Screen with Gasket		
8.700-765.0	3779801 Gasket Cover	Gasket Cover		

### BURNER TRANSFORMERS - BECKETT



- 10,000V Spark
- 2.2 AMP @ 120V
- 8.5 lbs.
- Traditional Copper-Wire Wound

PART NO.	BECKETT NO.	MOUNTING	VOLT
8.751-780.0*	5250001U	AF/AFG/NX/CF375	240V
9.803-060.0*	51824U	A-SF-SR-SM	120V
8.751-781.0*	5250002U	SM/SF/CF500/CF800	240V

\*Bottom Mount

### BURNER TRANSFORMERS - ALLANSON



- 10,000V Spark
- 2.2 AMP @ 120V
- 8.5 lbs.
- FranceFormer

PART NO.	ALLANSON NO.	WAYNE NO.	MOUNTING	VOLT
8.700-804.0	2721-620	23101/E	Side / EH-EHA	120V
8.700-806.0	2721-628G	23101/M	Back / M-MSR	120V
8.700-809.0	2744-620	23103/E	Side / EH-EH	230V
8.700-798.0	2729-619	23103/M	Back	220V

**BURNER IGNITOR / BASE PLATES - BECKETT**

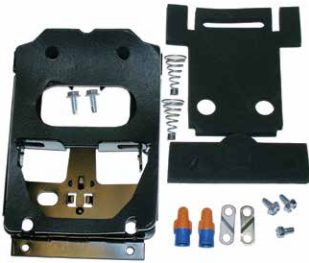

PART NO.	BECKETT NO.	DESCRIPTION
8.701-116.0	51830U	A, Trans / Ign
8.701-117.0	51831U	S, Trans / Ign
8.701-118.0	51833U	E, Trans / Ign
8.701-119.0	51829U	M, Trans / Ign

**BURNER IGNITORS - WAYNE**



- Solid-State Technology
- 14,000V Spark

- Only .35 AMP @ 120V
- 1.7 lbs.



PART NO.	WAYNE NO.	MOUNTING	VOLT
8.700-810.0	23101-FH	Side, FH-FHA	120V
8.700-802.0	101295-SERE	Side, EH/EHA/EHASR	120V
8.700-803.0	101295-SERM	Back, M/MH/MSR	120V
8.700-801.0	31812-002	Back, M-MSR	220V
8.700-807.0	31812-003	Bottom, W/M	12V
8.700-820.0	31813-003	Side Mount (E)	12V

**BURNER IGNITORS - ALLANSON**



PART NO.	ALLANSON NO.	WAYNE NO.	MOUNTING	VOLT
8.700-800.0	2280-620S	31813-002	Side, E/EH/EHA/EHS	220V

**FUEL SOLENOID VALVE - 12V DC KIP**



- Brass Body
- 12V DC Coil
- 1/8" NC, FPT, I/O Ports
- Conduit Connector
- 5/64" Orifice = 6 Watt

PART NO.	DESCRIPTION
8.701-120.0	Fuel Solenoid Valve



## FUEL SOLENOID VALVES / COILS - SUNTEC



- PSI: 300
- 1/8" FPT Inlet
- Unitized mounting on Suntec fuel pumps
- Uses Standard Suntec Coil

PART NO.	DESCRIPTION
8.700-779.0	110V Oil Valve, Non-Delay, R642NL
8.700-780.0	220V Oil Valve, Non-Delay, R753NL
8.700-782.0	12 Oil Valve, Non-Delay, R261NL
8.900-081.0	110V Coil with Cord Set
8.900-082.0	230V Coil with Cord Set
8.900-080.0	12/24 Coil with Cord Set
9.802-640.0	115V Coil without Cord Set
9.802-641.0	230V Coil without Cord Set
8.700-794.0	12/24V DC Coil without Cord Set
8.700-795.0	Cord Set Only
8.900-079.0	8mm Nut for Old Style Coil

## GAS JETS



PART NO.	DRILL SIZE	ORIFICE SIZE	USE
<b>GAS JETS FOR BURNER RINGS</b>			
8.710-215.0	#52	(.0635)	NG
8.710-216.0	#54	(.055)	NG
8.710-217.0	#62	(.038)	LP
8.717-377.0	#63	(.037)	LP
8.710-218.0	#65	(.035)	LP
8.710-219.0	#66	(.033)	LP
9.802-684.0	#69	(.029)	LP
8.710-214.0	Blank (Must Be Drilled)		

## GAS VALVES - HONEYWELL



9.803-615.0



9.803-616.0



8.718-048.0



9.803-612.0



9.803-613.0



9.803-610.0

PART NO.	DESCRIPTION
<b>NATURAL GAS - SMALL MILLIVOLT VALVE</b>	
9.803-615.0	Natural Gas Millivolt Valve, 3/4" NPT
9.803-617.0	NG Pilot for Piezo Ignitor
9.803-611.0	Thermopile/Powerpile with Spade Terminals, 47"
9.803-614.0	LP Conversion Kit (NG to LP)
8.718-116.0	NG Conversion Kit (LP to NG)
<b>NATURAL GAS - SMALL ELECTRONIC IGNITION VALVE</b>	
9.803-616.0	Natural Gas Electronic Ignition Valve, 24V, 3/4" NPT
9.803-618.0	LP Conversion Kit (NG to LP)
8.718-112.0	NG Conversion Kit (LP to NG)

PART NO.	DESCRIPTION
<b>NATURAL GAS / LP - LARGE ELECTRONIC IGNITION VALVE</b>	
8.718-050.0	NG Diaphragm Gas Valve, Single Stage Pressure Regulating, Slow Opening (No LP Conversion Kit)
8.718-048.0	LP Diaphragm Gas Valve, Single Stage Pressure Regulating, Slow Opening. (No NG Conversion Kit)
9.803-612.0	Pilot Gas Solenoid Valve, 24V, 1/4" Small Normally Closed
<b>ELECTRONIC IGNITION</b>	
9.803-613.0	Electronic Ignition Controller Back 90 sec TFI
9.803-610.0	Pilot, Electronic Ignition
9.803-562.0	48" Ignition Cable
8.905-681.0	60" Ignition Cable
8.930-332.0	69" Ignition Cable

**GAS REGULATORS - NATURAL GAS**

■ A.G.A. Design Certified

■ CGA Certified



PART NO.	SIZE	VOLTAGE	MODEL NO.	BRAND
9.803-616.0	3/4"	24V	VR8304M4002B	Honeywell
8.710-182.0	3/4"	120V	36C03A-410	White Rogers
8.717-766.0	3/4"	Millivolt	VS820A1088/U	Honeywell
8.718-099.0	3/4"	24V	SV9601M4167/B	Honeywell
8.710-174.0	1"	24V	700-059	Robert Shaw with Pilot
9.802-674.0	1"	24V	7000 DERHC, 5N2-501-531	Robert Shaw

**GAS REGULATORS - LP GAS CONVERSION KITS**

■ A.G.A. Design Certified

■ CGA Certified

PART NO.	MODEL NO.	DESCRIPTION
8.718-111.0	F0092 073700S1 (F92-0737)	Fits White Rogers: 36C Series
9.803-614.0	391937/U	Fits: V/VR800 Series, Standard & Delay Models
9.803-618.0	393691/U	Fits Honeywell: VR/SV Series
8.710-187.0	1751-013	Fits Robert Shaw: 7000, 7010, 7100, 7200 and 7222

**GAS REGULATORS - LP**



8.717-746.0



9.802-633.0

- High Quality Fischer Regulators
- High and Low Pressure

PART NO.	MODEL NO.	DESCRIPTION
8.717-752.0	LV404B96	LP,F.POL X 3/4" F.NPT, 525K BTU
8.717-746.0	R122HAAJ	1st Stage,High Pressure,1,180,000 BTU
8.717-747.0	R622CFF	2nd Stage, Low Pressure- Reducing
8.717-749.0	R632CFF	Integral 2 Stage, 1/4" x 3/4" NPT
9.802-633.0		LP Assembly, Includes High / Low Pressure Assy

**PROPANE GAS HOSE**



PART NO.	DESCRIPTION
8.711-853.0	LP 1/4" x 10' POL x POL
8.711-856.0	LP 1/2" x 48", MNPT Both Ends
8.711-854.0	LP 1/4" x 18" MPOL Both Ends
8.711-864.0	LP 3/4" x 16" MNPT Both Ends

### DRAFT DIVERTERS & RAIN CAPS



- Prevents backdrafts and keeps cold air out
- Fits on Standard Stove Pipe
- Hot Dipped Galvanized
- Prevents water from running down vent pipes

PART NO.	DESCRIPTION
8.717-764.0	8" Oil Fired, Barometric Dampener
8.717-728.0	8", Round Gas-Fired
9.801-040.0	10", Round Gas-Fired
8.717-730.0	12", Round Gas-Fired
<b>RAIN CAPS</b>	
9.105-845.0	8", Exhaust Stack, Cap
8.717-731.0	10", Exhaust Stack, Cap
8.717-732.0	12", Exhaust Stack, Cap

### GAS PILOTS



PART NO.	DESCRIPTION
8.718-100.0	LP Orifice HS, Q3480C 1437 (829858)
8.718-101.0	NG Orifice HS Q3480C 1205 (829977)
8.718-011.0	NG Pilot Burner & Ignition with Orifice (Q345A1073/B)
9.802-685.0	NG Pilot 77623, A3-S, 77623 2SH60
9.803-610.0	NG Electronic Ignition Pilot

### GAS VALVES - 1" BY ROBERT SHAW

Universal type for new equipment or replacement.



- Manual Gas Cock
- Auto-Pilot Safety Valve
- Wiring and Hardware Included
- Pilot Gas Filter
- 600,000 BTU LP Gas  
720,000 BTU Natural Gas
- 1" Inlet / Outlet

\*Kit is for 8.710-174.0 and includes: gas valve, flame sensor, electrode pilot relight and harness

PART NO.	DESCRIPTION
8.710-179.0	24V AC/NG, Standing Pilot
8.710-174.0	24V AC/NG, Electronic Ignition
8.710-181.0	700 MV, Natural Gas
8.710-163.0*	24V Retrofit Kit (NG) 720,000 BTU
9.802-677.0	Ignition. Ctrl. Module- SP-745 LP Conversion Kit Below

### GAS CONVERSION KITS - LP - ROBERT SHAW

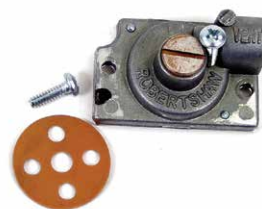

- Convert NG to LP

PART NO.	DESCRIPTION
8.710-187.0	1" LP Conversion Kit
8.710-164.0	LP Orifice .010

### POWERED DAMPER



PART NO.	DESCRIPTION
8.749-806.0	Powered Damper, 10"
8.753-171.0	Powered Damper, 12"
8.755-253.0	Powered Damper, 8"
8.749-807.0	Wiring Harness for Powered Damper

**FUEL NOZZLES - DELAVAN - 45° & 60°**

Select proper size for maximum burner efficiency.



PART NO.	DESCRIPTION	GPH
<b>45° W HOLLOW</b>		
8.701-013.0	Delavan Fuel Nozzles	2.25
<b>45° A HOLLOW</b>		
8.717-282.0	Delavan Fuel Nozzles	1.00
8.717-285.0	Delavan Fuel Nozzles	1.20
8.701-001.0	Delavan Fuel Nozzles	1.25
8.701-002.0	Delavan Fuel Nozzles	1.35
8.701-003.0	Delavan Fuel Nozzles	1.50
8.701-004.0	Delavan Fuel Nozzles	1.75
8.701-005.0	Delavan Fuel Nozzles	2.00
8.701-014.0	Delavan Fuel Nozzles	2.25
<b>45° B HOLLOW</b>		
8.701-009.0	Delavan Fuel Nozzles	0.90
8.701-008.0	Delavan Fuel Nozzles	1.25
8.700-847.0	Delavan Fuel Nozzles	1.35
8.701-010.0	Delavan Fuel Nozzles	1.50
8.701-012.0	Delavan Fuel Nozzles	2.25
<b>60° W</b>		
8.740-139.0	Delavan Fuel Nozzles	1.25
8.701-007.0	Delavan Fuel Nozzles	1.35
8.701-015.0	Delavan Fuel Nozzles	1.50
8.701-016.0	Delavan Fuel Nozzles	1.65
8.701-017.0	Delavan Fuel Nozzles	1.75
8.701-018.0	Delavan Fuel Nozzles	2.00
8.701-019.0	Delavan Fuel Nozzles	2.25
<b>60° AR</b>		
8.717-286.0	Delavan Fuel Nozzles	1.20
8.717-287.0	Delavan Fuel Nozzles	1.50

PART NO.	DESCRIPTION	GPH
<b>60° A HOLLOW</b>		
8.700-850.0	Delavan Fuel Nozzles	0.50
8.700-851.0	Delavan Fuel Nozzles	0.60
8.700-852.0	Delavan Fuel Nozzles	0.65
8.700-853.0	Delavan Fuel Nozzles	0.85
8.700-854.0	Delavan Fuel Nozzles	0.90
8.700-855.0	Delavan Fuel Nozzles	1.00
8.700-856.0	Delavan Fuel Nozzles	1.10
8.700-857.0	Delavan Fuel Nozzles	1.20
8.700-858.0	Delavan Fuel Nozzles	1.25
8.700-859.0	Delavan Fuel Nozzles	1.35
8.717-328.0	Delavan Fuel Nozzles	1.50
8.700-861.0	Delavan Fuel Nozzles	1.65
8.700-862.0	Delavan Fuel Nozzles	1.75
8.700-863.0	Delavan Fuel Nozzles	2.00
8.700-864.0	Delavan Fuel Nozzles	2.25
8.700-865.0	Delavan Fuel Nozzles	2.50
8.700-866.0	Delavan Fuel Nozzles	2.75
8.700-867.0	Delavan Fuel Nozzles	3.25
8.700-999.0	Delavan Fuel Nozzles	6.00
<b>60° A SOLID</b>		
8.700-868.0	Delavan Fuel Nozzles	0.50
8.700-869.0	Delavan Fuel Nozzles	0.60
8.700-870.0	Delavan Fuel Nozzles	0.75
8.700-871.0	Delavan Fuel Nozzles	0.85
8.700-872.0	Delavan Fuel Nozzles	0.90
8.700-873.0	Delavan Fuel Nozzles	1.00
8.700-874.0	Delavan Fuel Nozzles	1.10
8.700-875.0	Delavan Fuel Nozzles	1.20
8.700-876.0	Delavan Fuel Nozzles	1.25
8.700-877.0	Delavan Fuel Nozzles	1.35
8.700-878.0	Delavan Fuel Nozzles	1.50
8.700-879.0	Delavan Fuel Nozzles	1.65
8.700-880.0	Delavan Fuel Nozzles	1.75
8.700-881.0	Delavan Fuel Nozzles	2.25
8.700-882.0	Delavan Fuel Nozzles	2.50
8.700-883.0	Delavan Fuel Nozzles	2.75
8.700-884.0	Delavan Fuel Nozzles	3.50
8.700-885.0	Delavan Fuel Nozzles	4.00
9.841-677.0	Delavan Fuel Nozzles	6.50
8.700-886.0	Delavan Fuel Nozzles	8.00

**FUEL NOZZLES - DELAVAN - 70°**

Select proper size for maximum burner efficiency.



PART NO.	DESCRIPTION	GPH
<b>70° AR-D</b>		
8.756-261.0	Delavan Fuel Nozzles	1.00
8.756-262.0	Delavan Fuel Nozzles	1.25
8.756-263.0	Delavan Fuel Nozzles	1.50
8.756-264.0	Delavan Fuel Nozzles	1.75
8.756-265.0	Delavan Fuel Nozzles	2.00
<b>70° AR-DZ</b>		
8.755-760.0	Delavan Fuel Nozzles	1.25
8.755-761.0	Delavan Fuel Nozzles	1.50
8.755-762.0	Delavan Fuel Nozzles	1.75
8.755-763.0	Delavan Fuel Nozzles	2.00
<b>70° AZ</b>		
8.755-845.0	Delavan Fuel Nozzles	1.75
<b>70° WZ</b>		
8.755-766.0	Delavan Fuel Nozzles	1.75
8.755-764.0	Delavan Fuel Nozzles	2.00
8.755-765.0	Delavan Fuel Nozzles	2.25

PART NO.	DESCRIPTION	GPH
<b>70° A HOLLOW</b>		
8.700-887.0	Delavan Fuel Nozzles	.50
8.700-888.0	Delavan Fuel Nozzles	.75
8.717-275.0	Delavan Fuel Nozzles	.85
8.717-276.0	Delavan Fuel Nozzles	1.00
9.105-583.0	Delavan Fuel Nozzles	1.10
8.717-277.0	Delavan Fuel Nozzles	1.20
8.723-910.0	Delavan Fuel Nozzles	1.35
8.717-278.0	Delavan Fuel Nozzles	1.50
8.700-892.0	Delavan Fuel Nozzles	1.75
9.106-987.0	Delavan Fuel Nozzles	2.00
8.717-280.0	Delavan Fuel Nozzles	2.25
8.700-893.0	Delavan Fuel Nozzles	2.50
8.700-894.0	Delavan Fuel Nozzles	3.00
8.700-895.0	Delavan Fuel Nozzles	3.25
<b>70° B SOLID</b>		
8.700-896.0	Delavan Fuel Nozzles	.75
8.700-897.0	Delavan Fuel Nozzles	1.00
8.700-898.0	Delavan Fuel Nozzles	1.20
8.700-899.0	Delavan Fuel Nozzles	1.25
8.700-900.0	Delavan Fuel Nozzles	1.35
8.700-901.0	Delavan Fuel Nozzles	1.50
8.700-902.0	Delavan Fuel Nozzles	1.65
8.700-903.0	Delavan Fuel Nozzles	1.75
8.700-904.0	Delavan Fuel Nozzles	2.00
8.700-905.0	Delavan Fuel Nozzles	2.25
8.700-906.0	Delavan Fuel Nozzles	2.50
8.700-907.0	Delavan Fuel Nozzles	3.50
8.700-908.0	Delavan Fuel Nozzles	4.00
8.700-909.0	Delavan Fuel Nozzles	5.00
8.700-910.0	Delavan Fuel Nozzles	8.00

**FUEL NOZZLES - DELAVAN - 80°**

Select proper size for maximum burner efficiency.

PART NO.	DESCRIPTION	GPH
<b>80° W</b>		
8.723-697.0	Delavan Fuel Nozzles	.85
8.723-698.0	Delavan Fuel Nozzles	.90
8.701-022.0	Delavan Fuel Nozzles	1.00
8.723-699.0	Delavan Fuel Nozzles	1.10
8.723-700.0	Delavan Fuel Nozzles	1.20
8.701-027.0	Delavan Fuel Nozzles	1.25
8.723-701.0	Delavan Fuel Nozzles	1.35
8.701-021.0	Delavan Fuel Nozzles	1.50
8.701-020.0	Delavan Fuel Nozzles	1.65
8.701-023.0	Delavan Fuel Nozzles	1.75
8.717-342.0	Delavan Fuel Nozzles	2.00
8.701-025.0	Delavan Fuel Nozzles	2.25
8.701-026.0	Delavan Fuel Nozzles	2.50
8.701-028.0	Delavan Fuel Nozzles	2.75
8.701-029.0	Delavan Fuel Nozzles	3.00
8.701-030.0	Delavan Fuel Nozzles	3.25
8.701-031.0	Delavan Fuel Nozzles	3.50
8.701-036.0	Delavan Fuel Nozzles	4.00
<b>80° AZ</b>		
8.754-928.0	Delavan Fuel Nozzles	1.25
8.754-894.0	Delavan Fuel Nozzles	1.35
8.755-198.0	Delavan Fuel Nozzles	1.50
8.756-364.0	Delavan Fuel Nozzles	1.75
8.755-197.0	Delavan Fuel Nozzles	2.00
8.756-330.0	Delavan Fuel Nozzles	2.25
<b>80° BZ</b>		
8.756-861.0	Delavan Fuel Nozzles	1.00
8.756-718.0	Delavan Fuel Nozzles	1.25
8.756-723.0	Delavan Fuel Nozzles	1.50
8.756-015.0	Delavan Fuel Nozzles	1.75
8.756-699.0	Delavan Fuel Nozzles	2.00
8.756-759.0	Delavan Fuel Nozzles	2.25
8.756-900.0	Delavan Fuel Nozzles	2.50
8.756-491.0	Delavan Fuel Nozzles	2.75
8.754-893.0	Delavan Fuel Nozzles	3.00
8.755-048.0	Delavan Fuel Nozzles	3.25
8.755-049.0	Delavan Fuel Nozzles	3.50
8.756-697.0	Delavan Fuel Nozzles	4.00
<b>80° A HOLLOW</b>		
8.700-911.0	Delavan Fuel Nozzles	.50
8.700-912.0	Delavan Fuel Nozzles	.60
8.700-913.0	Delavan Fuel Nozzles	.65
8.700-914.0	Delavan Fuel Nozzles	.75
8.700-915.0	Delavan Fuel Nozzles	.85
8.717-333.0	Delavan Fuel Nozzles	.90

PART NO.	DESCRIPTION	GPH
<b>80° A HOLLOW (CONTINUED)</b>		
8.700-916.0	Delavan Fuel Nozzles	1.00
8.700-917.0	Delavan Fuel Nozzles	1.10
8.717-323.0	Delavan Fuel Nozzles	1.20
8.700-919.0	Delavan Fuel Nozzles	1.25
9.802-584.0	Delavan Fuel Nozzles	1.35
8.700-921.0	Delavan Fuel Nozzles	1.50
8.700-922.0	Delavan Fuel Nozzles	1.65
8.717-329.0	Delavan Fuel Nozzles	1.75
8.700-924.0	Delavan Fuel Nozzles	2.00
8.717-347.0	Delavan Fuel Nozzles	2.25
8.700-926.0	Delavan Fuel Nozzles	2.50
8.700-927.0	Delavan Fuel Nozzles	2.75
8.700-928.0	Delavan Fuel Nozzles	3.00
8.700-929.0	Delavan Fuel Nozzles	3.50
8.700-930.0	Delavan Fuel Nozzles	4.00
8.717-331.0	Delavan Fuel Nozzles	4.50
<b>80° B SOLID</b>		
8.700-931.0	Delavan Fuel Nozzles	.50
8.700-932.0	Delavan Fuel Nozzles	.60
8.700-933.0	Delavan Fuel Nozzles	.65
8.700-934.0	Delavan Fuel Nozzles	.75
8.700-935.0	Delavan Fuel Nozzles	.85
8.700-936.0	Delavan Fuel Nozzles	.90
8.700-937.0	Delavan Fuel Nozzles	1.00
8.700-938.0	Delavan Fuel Nozzles	1.10
8.700-939.0	Delavan Fuel Nozzles	1.20
8.717-350.0	Delavan Fuel Nozzles	1.25
8.717-358.0	Delavan Fuel Nozzles	1.35
8.717-351.0	Delavan Fuel Nozzles	1.50
8.700-943.0	Delavan Fuel Nozzles	1.65
8.717-352.0	Delavan Fuel Nozzles	1.75
8.717-353.0	Delavan Fuel Nozzles	2.00
8.700-946.0	Delavan Fuel Nozzles	2.25
8.700-947.0	Delavan Fuel Nozzles	2.50
8.717-330.0	Delavan Fuel Nozzles	2.75
8.717-354.0	Delavan Fuel Nozzles	3.00
8.700-950.0	Delavan Fuel Nozzles	3.25
8.700-951.0	Delavan Fuel Nozzles	3.50
8.700-952.0	Delavan Fuel Nozzles	4.00
8.717-367.0	Delavan Fuel Nozzles	4.50
8.717-357.0	Delavan Fuel Nozzles	5.00
8.700-956.0	Delavan Fuel Nozzles	6.00
8.700-953.0	Delavan Fuel Nozzles	6.50
8.700-957.0	Delavan Fuel Nozzles	8.00
8.700-958.0	Delavan Fuel Nozzles	8.50
8.700-959.0	Delavan Fuel Nozzles	9.00

**FUEL NOZZLES - DELAVAN - 90°**

Select proper size for maximum burner efficiency.



PART NO.	DESCRIPTION	GPH
<b>90° W</b>		
8.701-006.0	Delavan Fuel Nozzles	1.00
8.701-037.0	Delavan Fuel Nozzles	1.35
8.701-038.0	Delavan Fuel Nozzles	1.50
8.701-039.0	Delavan Fuel Nozzles	1.65
8.701-023.0	Delavan Fuel Nozzles	1.75
8.701-032.0	Delavan Fuel Nozzles	2.00
8.701-034.0	Delavan Fuel Nozzles	2.25
8.701-035.0	Delavan Fuel Nozzles	2.75
<b>90° AZ</b>		
8.754-890.0	Delavan Fuel Nozzles	1.00
8.754-891.0	Delavan Fuel Nozzles	1.50
8.754-953.0	Delavan Fuel Nozzles	1.75
8.755-053.0	Delavan Fuel Nozzles	2.00
8.755-030.0	Delavan Fuel Nozzles	2.25
8.755-052.0	Delavan Fuel Nozzles	2.75
8.755-051.0	Delavan Fuel Nozzles	4.00
<b>90° BZ</b>		
8.754-895.0	Delavan Fuel Nozzles	1.25
8.756-179.0	Delavan Fuel Nozzles	1.35
8.754-916.0	Delavan Fuel Nozzles	1.50
8.754-888.0	Delavan Fuel Nozzles	2.00
8.754-889.0	Delavan Fuel Nozzles	2.25
8.754-986.0	Delavan Fuel Nozzles	2.75
<b>90° A HOLLOW</b>		
8.700-960.0	Delavan Fuel Nozzles	.60
8.700-961.0	Delavan Fuel Nozzles	.65
8.700-962.0	Delavan Fuel Nozzles	.75
8.723-911.0	Delavan Fuel Nozzles	.85
8.700-963.0	Delavan Fuel Nozzles	.90
9.802-583.0	Delavan Fuel Nozzles	1.00
8.717-332.0	Delavan Fuel Nozzles	1.10
8.700-966.0	Delavan Fuel Nozzles	1.25
8.700-967.0	Delavan Fuel Nozzles	1.35
9.802-585.0	Delavan Fuel Nozzles	1.50
8.700-969.0	Delavan Fuel Nozzles	1.65

PART NO.	DESCRIPTION	GPH
<b>90° A HOLLOW (CONTINUED)</b>		
8.700-970.0	Delavan Fuel Nozzles	1.75
8.700-971.0	Delavan Fuel Nozzles	2.00
8.700-972.0	Delavan Fuel Nozzles	2.25
8.700-973.0	Delavan Fuel Nozzles	2.50
8.700-974.0	Delavan Fuel Nozzles	2.75
8.700-975.0	Delavan Fuel Nozzles	3.00
8.717-336.0	Delavan Fuel Nozzles	3.25
8.700-977.0	Delavan Fuel Nozzles	3.50
8.700-978.0	Delavan Fuel Nozzles	4.00
8.717-338.0	Delavan Fuel Nozzles	4.50
8.700-979.0	Delavan Fuel Nozzles	5.00
8.700-980.0	Delavan Fuel Nozzles	6.00
<b>90° B SOLID</b>		
8.700-981.0	Delavan Fuel Nozzles	.50
8.700-982.0	Delavan Fuel Nozzles	.75
8.700-983.0	Delavan Fuel Nozzles	.85
8.700-984.0	Delavan Fuel Nozzles	1.00
8.700-985.0	Delavan Fuel Nozzles	1.10
9.802-582.0	Delavan Fuel Nozzles	1.25
8.700-987.0	Delavan Fuel Nozzles	1.35
8.700-988.0	Delavan Fuel Nozzles	1.50
8.700-989.0	Delavan Fuel Nozzles	1.65
9.802-575.0	Delavan Fuel Nozzles	1.75
9.802-576.0	Delavan Fuel Nozzles	2.00
9.802-577.0	Delavan Fuel Nozzles	2.25
9.802-586.0	Delavan Fuel Nozzles	2.50
8.700-994.0	Delavan Fuel Nozzles	2.75
8.700-995.0	Delavan Fuel Nozzles	3.00
8.700-996.0	Delavan Fuel Nozzles	3.25
8.700-997.0	Delavan Fuel Nozzles	3.50
8.700-998.0	Delavan Fuel Nozzles	4.00
8.717-374.0	Delavan Fuel Nozzles	4.50
8.701-000.0	Delavan Fuel Nozzles	6.00

**FUEL NOZZLES - CHECK VALVE - "SNAP"**

Spring-loaded "snap" check valve replaces filter element on fuel nozzle. Valve opens when fuel pump pressure reaches 130 PSI and "snaps" shut when fuel pressure drops below 130 PSI. Stops "smokey" burners at start-up and eliminates "shutdown" after burn and reduces soot build-up in coil.

- Reduces nozzle fouling caused by residual fuel in orifice
- Easy field installation in standard fuel nozzles



PART NO.	DESCRIPTION	PSI
8.900-083.0	Snap Fuel Valve	100
8.900-084.0	Snap Fuel Valve	130
8.700-845.0	Snap Check Valve, 5/PK	130
8.700-844.0	Snap Check Valve, 5/PK	100

**GAS VALVES - LP OR NATURAL**

Universal-type for building new systems or field replacement. 750 MV, 24V or 120V controls by White-Rogers.



- 335,000 BTU Max
- 3/4" Inlet / Outlet
- All adjustments and wiring connections on top of valve
- Automatic Outlet Pressure Regulator
- A.G.A. Design Certified, C.G.A. Certified



PART NO.	DESCRIPTION
8.710-172.0	Universal, 24V, Includes LP Conv. Kit (1)
8.710-182.0	Universal 120V, Includes LP Conv. Kit (2)
8.710-183.0	Universal, Standing Pilot, 750 MV (1)
8.750-110.0	3/4" NG to LP Conversion Kit
8.750-109.0	3/4" LP to NG Conversion Kit

**WHITE-RODGERS REPAIR PARTS**

8.710-184.0	24V Cycle Pilot Control (347425), 1/4" Spade Terminals, High Voltage
8.710-198.0	Gas Ignition Electrode with Universal Mounting Bracket & 24" Lead

(1) Includes two 3/4" x 1/2" all-thread plated bushings and valve instructions. (2) Includes L.P. Kit, two 3/4" x 1/2" and one 1/2" x 3/8" all-thread plated bushings and all instructions.

**GAS VALVE ACCESSORY COMPONENTS**

Use with both 3/4" and 1" models on this page.



8.710-190.0

PART NO.	DESCRIPTION
8.710-190.0	600/750 MV Generator 36" Length
8.710-191.0	Pilot, Universal-Kit with Standard Flame
8.718-092.0	Thermocouple, Universal, 24" Length, Cap Tube
8.710-196.0	Thermocouple, Universal, 36" Length, Cap Tube
9.802-686.0	Thermopile VNG, with Spade Terminals, 47" Length



## INSULATION AND RIGID DISC / DONUTS

Refractory-grade ceramic Kaowool formed; retains heat inside coil for better fuel efficiency and paint protection.



PART NO.	DESCRIPTION	THICKNESS	WIDTH	LENGTH
<b>"RIGID FORMED" DONUT AND DISCS</b>				
8.704-807.0	Donut	.88"	18" 6"/4	4"
8.704-810.0	Donut	.88"	16" 6"/4	4"
8.717-474.0	Donut		24"	
8.704-808.0	Disc	1/2"	18"	
8.704-809.0	Disc	1/2"	16"	
8.717-475.0	Disc		24"	
<b>INSULATION BLANKET</b>				
8.901-288.0	Coil Wrap	1"	24"	4'
8.901-289.0	Coil Wrap	1"	24"	5'
8.704-800.0	Coil Wrap	1"	24"	6'
8.704-802.0	Full Roll	1/2"	24"	37.5'
8.704-805.0	Full Roll	1"	24"	25'

**FLOW SWITCHES - LEGACY MV60 & AP500** 



- Temperature: 180°F
- AMP: 3, 12-250V
- Horizontal & Vertical Mount
- 3/8" FPT Inlet / Outlet
- 2 Wire Reed
- 62" Cord Length

PART NO.	DESCRIPTION	PSI	GPM
8.933-006.0	MV-60, Vertical or Horizontal Mount	5660	10.0
8.712-244.0	AP-500, Vertical Mount Only	4350	8.0
9.803-266.0	Reed Switch (AP) (2 wire)		

**FLOW SWITCHES - ST-5 & ST-6**



ST-5



ST-6

- Temperature: 180°F
- Brass Body

PART NO.	DESCRIPTION
9.112-680.0	ST-5 Gray, Vertical/ Horizontal Mount, 75-5075 PSI Max, 1-7.8 GPM, 3/8" FPT Inlet/Outlet, 1 A-250 V (47" Wire Length)
8.757-669.0	ST-5 Black, Vertical Mount, 75-4380 PSI Max, 1-8 GPM, 3/8" FPT Inlet/Outlet, Contact: 1A-250V (48" Wire Length)
8.757-668.0	ST-6 Vertical/Horizontal Mount, 75-5075 PSI Max, 1-8 GPM, 3/8 MPT Inlet/Outlet, 1 A-250 V (47" Wire Length)
8.757-670.0	Reed Switch for ST-5 and ST-6 New Style

**FLOW SWITCHES - PHOENIX WITH PILOT**



- PSI: 18 - 4000
- GPM: .75 - 16.0
- Temperature: 190°F
- AMP: 3, 120V
- 3/8" F Inlet / Outlet Ports
- 96" Reed Cord
- Includes 8 mm Pilot
- 2.5 lbs.
- Mounting Hole

PART NO.	DESCRIPTION
8.712-252.0	Switch with Pilot
8.712-253.0	Reed Switch

**FLOW SWITCHES - LEGACY** 

Spring return float allows full mounting versatility.



- PSI: 4050
- Rated Pressure: 3650
- GPM: 8.0
- Temperature: 175°F
- Vertical Mount
- Forged Brass Body
- 3/8" MPT Inlet / Outlet
- 1 Amp Switch, 230V, 36" Cord
- Solenoid Control

PART NO.	DESCRIPTION
8.712-246.0	Flow Switch

**FLOW SWITCHES - ST-7 WITH MICRO SWITCH**



- PSI: 5000
- GPM: 12.0
- Temperature: 176°F
- 3/8" FPT Inlet / Outlet
- Micro Switch
- 10.1 A- 250 V

PART NO.	DESCRIPTION
8.755-296.0	ST-7 Horizontal or Vertical Mount (47" Wire Length)

**FLOW SWITCHES - GP - TMT**



- PSI: 5000
- GPM: 1.5 at PSI: 50
- Minimal Pressure Drop up to 12 GPM Flow
- Activates with 1.5 GPM Flow
- Temperature: 40° - 180°F
- AMP: 5, 250V
- 3/8" F Inlet / Outlet Ports
- 48" Electrical Lead Length
- 1.0 lbs.
- Can be mounted in any position
- Micro-Switch technology eliminates reed switch
- No Spring, uses Magnets for all Movements

PART NO.	DESCRIPTION
8.712-258.0	Inline Flow Switch

## FLOW SWITCHES - ST-505 STAINLESS-STEEL



- PSI: 75 - 8700
- GPM: 1.0 - 8.0
- Temperature: 176°F
- 3/8" FPT Inlet / Outlet
- Stainless-steel
- 3 A, Max/ 250 V Max
- Free floating brass magnet

PART NO.	DESCRIPTION
8.723-665.0	ST-505 Vertical Mount, 47" Lead

## VAC SWITCHES - BURNER CONTROL

Normally open (NO) switch closes when pump vacuum begins drawing water and opens when vacuum is broken due to pump shutdown or empty water tank.



- Temperature Max: 140°F
- Heavy-duty, 16 Amp Contacts
- 1/4" FPT Connect

PART NO.	DESCRIPTION
8.712-391.0	1.5" (HG) Vac Switch
8.712-392.0	2.5" (HG) Vac Switch
8.712-393.0	4.5" (HG) Vac Switch

## PRESSURE SWITCHES - LEGACY

Operation without opening switch case:

Blue = Common

CONNECT: Red / Blue = N/C, Blue / Brown = N/O



- PSI: 3600
- Temperature: 200°F
- AMP: 15, 115V or 230V AC
- Stainless-Steel Plunger
- 1/4" and 3/8" MPT Nipple
- 3 Wire, Internally Wired for either N/O or N/C
- 42" Wire Length

PART NO.	DESCRIPTION
8.712-261.0	Pressure Switch (Switches @ 360 PSI)
8.712-262.0	Pressure Switch 1/4" MPT (Switches @ 580 PSI)
8.751-272.0	Pressure Switch 3/8" (Switches @ 580 PSI)

## PRESSURE SWITCHES - COMPACT & PS-6 SS

3- & 5-Amp rating provides the switching power to control fuel solenoids just like the large switches.



- Temperature: 194°F
- 1/4" Brass MPT Connect
- 3 Wire Cable for use in either NC or NO application: Blue = Common, Brown = No, Red = NC

PART NO.	DESCRIPTION
8.712-260.0	Compact Switch- 54" 2 Wire Lead, Normally Open, 5 A- 250 V, 725-3000 Max PSI
8.712-270.0	PS-6 Switch- 16 A- 250 V, 47" 3 Wire Lead, 4060 PSI MAX, 435 Switching Pressure, SS Plunger

## PRESSURE SWITCHES - PR16 - BLACK



- Rated PSI: 3625  
Max PSI: 4060
- Switching Pressure PSI: 580
- Temperature: 195°F
- AMP: 16, 250V
- Brass Stem and Stainless-Steel Nipple
- 8 oz.
- Normally Open

PART NO.	INLET	WIRE LENGTH
9.802-458.0	1/4" MPT	45" Wire
8.716-125.0	3/8" MPT	65" Wire

## PRESSURE SWITCHES - PA - PR1 - RED



- Rated PSI: 8700  
Max PSI: 9570
- Switching Pressure PSI: 640
- Temperature: 195°F
- AMP: 15, 250V
- All Stainless-Steel Construction
- 3/8" Male Inlet
- 10 oz.
- 44" Wire Length

PART NO.	DESCRIPTION
8.712-267.0	PR1 - Red Pressure Switch
8.704-572.0	Heavy-duty Micro Switch

**SWITCHES - TOGGLE - PUSH BUTTON**



- 7/16" Mounting Bushing
- 1/2" Diameter Mounting Hole Required
- Mounting Hardware Included
- Non-Illuminated

PART NO.	DESCRIPTION	HP*	CONNECTS
8.712-319.0*	SPST, 20A/125V -10A/250V AC	1.0	M/Spade
8.712-320.0	DPST, 20A/125V -10A/250V AC		M/Spade
8.709-705.0*	DPST, 20A/125V -10A/250V AC	1.5	Screw
8.709-704.0*	DPST, 20A/250V	2.0	Screw
8.709-054.0*	SPDT, 20A/125V -10A/250V AC	3/4	M/Spade
8.709-065.0*	DPDT, 20A/125V -10A/250V AC	3/4	M/Spade
8.716-078.0	SPST, 20A/125V -10A/250V AC	1.5	
8.709-706.0	Y500 - Switch Guard		
8.716-081.0	Waterproof Switch Protector		
PUSH BUTTON SWITCHES			
8.709-053.0	SPST, 3A/250V-6A/125V AC, Miniature- Push Button On/Off		Screw
8.709-064.0	SPST, 15A/125V AC, Push Button On/Off		Screw

\*Motor Rated

**SWITCHES - TOGGLE - MOTOR CONTROL**



- 20/30 A, 250/600 V DPST
- Rated For: 2, 3, 5 & 7.5 HP, Single Phase
- With or Without Box

PART NO.	DESCRIPTION
8.709-696.0	Switch Only
8.903-802.0	Switch & Rain Tight Box with Cover
8.709-708.0	Switch with NEMA 1 Enclosure: Not Rain Tight (Baldor Replacement)

**SWITCHES - THERMAL - HI-LIMIT - SNAP**



8.712-306.0

- PSI: 4000
- AMP: 15 at 110V, AMP: 10 at 220V
- 1/4" Male Spade Lug Terminals
- Normally Closed
- UL / CSA Rated, Bimetal Switch Componentets
- Heavy-Duty Brass Housing - 7000 PSI Collapse Rating
- Normally used with other adjustable or fixed range thermostat which regulates water temperature
- Does not turn back on until water has cooled 50° - 70°F
- Operates as a safety device to shut off burner to prevent machine (water) overheating flashing to steam

PART NO.	PROBE MPT	TEMP
8.712-301.0	3/8" x 1/2"	120°F
8.712-206.0	3/8"	140°F
8.753-450.0	3/8"	160°F
8.712-306.0	3/8" x 1/2"	180°F
8.712-311.0	3/8" x 1/2"	230°F
8.712-179.0	1/2"	180°F
8.712-308.0	1/2"	210°F
8.712-298.0	1/2"	230°F
8.712-316.0	1/2"	330°F
8.705-351.0	1/2" FPT x FPT	PVC Coupler

**SWITCHES - THERMAL - HI-LIMIT - SNAP WITH LEADS**



- AMP: 15 at 110V, AMP: 10 at 220V
- 1/4" Male Spade Lug Terminals
- 1/2" MPT external thread connects for attaching conduit or PVC wire connectors
- UL / CSA Rated, Bimetal Switch Componentets
- Does not turn back on until water has cooled 50° - 70°F
- Heavy-Duty Brass Housing - 7000 PSI Collapse Rating
- Normally used with other adjustable or fixed range thermostat which regulates water temperature
- Operates as safety device to shut off burner to prevent machine (water) overheating flashing to steam

PART NO.	PROBE MPT	WIRE LEAD	TEMP
8.712-185.0	1/2"	42"	225°F
8.712-205.0	1/2"	42"	340°F
8.751-363.0	1/2"	36" SJO 3 Wire	180°F
8.712-187.0	1/2"	42"	275°F

## CONNECTORS - DP - CUTLER-HAMMER

Cutler-Hammer



- Cutler-Hammer Quality
- Type C25 definite purpose contactors feature a compact, efficient design with low-VA coil
- Din Rail Mounting

PART NO.	COIL VOLTAGE	FL AMPS	MOTOR HP @ 115V 1PH	MOTOR HP @ 230V 1PH	MOTOR HP @ 230V 3PH	MOTOR HP @ 460V 3PH	MOTOR HP @ 575V 3PH
8.724-267.0	24V	15	.75	2	3	5	5
8.724-264.0	115V	15	.75	2	3	5	5
8.724-265.0	230V	15	.75	2	3	5	5
8.724-269.0	24V	25	2	3	7.5	10	10
8.724-268.0	115V	25	2	3	7.5	10	10
8.724-270.0	230V	25	2	3	7.5	10	10
8.724-271.0	460V	25	2	3	7.5	10	10
8.724-275.0	24V	30	2	5	10	15	15
8.724-272.0	115V	30	2	5	10	15	15
8.724-273.0	230V	30	2	5	10	15	15
8.724-280.0	24V	40	3	7.5	10	20	20
8.724-276.0	115V	40	3	7.5	10	20	20
8.724-277.0	230V	40	3	7.5	10	20	20
8.724-279.0	380V	40	3	7.5	10	20	20
8.724-278.0	460V	40	3	7.5	10	20	20
8.724-283.0	24V	50	3	10	15	30	30
8.724-281.0	115V	50	3	10	15	30	30
8.724-282.0	230V	50	3	10	15	30	30
8.724-286.0	24V	60	5	10	20	40	40
8.724-284.0	115V	60	5	10	20	40	40
8.724-285.0	230V	60	5	10	20	40	40
8.735-015.0*	115V	65	5	15	25	50	60

\*includes aux contact block

## SWITCHES / CONTACT BLOCKS - PUSH BUTTON - CUTLER-HAMMER

Cutler-Hammer

- Cutler-Hammer Quality
- Heavy-Duty
- Water Tight / Oil Tight



8.751-916.0



8.751-915.0



8.751-910.0



8.751-912.0

PART NO.	MODEL NO.	DESCRIPTION
9.803-666.0	CH C320KGS3	Aux Contact-N/O, N/C, 10A, Standard, Side Mounting
8.751-912.0	M22-K01	Contact Block-SPST-NC, 6A, 120V, Screw Terminal
8.751-913.0	M22-K10	Contact Block-SPST-NO for Non-Illum., Push Button, 6A, 500V, Screw Terminal
8.751-916.0	M22S-D-G	Switch, Green Push Button-SPST-NO, 22mm, Momentary, Flush Button, 6A, 500V, Screw Clamp Term.
8.751-915.0	M22S-DH-R	Switch, Red Push Button- SPST-NO/NC, 22mm, Momentary, Extended Button, 6A, 500V
8.751-910.0	M22S-WKV	Selector Switch Actuator- 22mm, 2 Position, Maintained, Non-Illum, Panel Mount

Specifications, product descriptions, product availability, and pricing subject to change without notice.

**OVERLOAD RELAYS FOR CONTRACTORS**

**Cutler-Hammer**



- Cutler-Hammer Quality
- Direct Heated Bimetal Elements
- Adjustable Trip Current
- Manual / Automatic Reset

PART NO.	AMP RANGE	MODEL #
8.724-297.0	0.4 - 0.6	XTOBP60CC1DP
8.724-298.0	0.6 - 1.0	XTOB001CC1DP
8.724-300.0	1.6 - 2.4	XTOB2P4CC1DP
8.724-301.0	2.4 - 4.0	XTOB004CC1DP
8.724-302.0	4.0 - 6.0	XTOB006CC1DP
8.724-303.0	6.0 - 10.0	XTOB010CC1DP
8.724-312.0	10.0 - 16.0	XTOB016CC1DP
8.724-304.0	16.0 - 24.0	XTOB024CC1DP
8.724-305.0	24.0 - 32.0	XTOB032CC1DP
8.724-306.0	24.0 - 40.0	XTOB040DC1DP
8.724-307.0	40.0 - 57.0	XTOB057DC1DP

**RELAY SWITCH**



PART NO.	DESCRIPTION
8.716-087.0	DPST-NO, 24V, Screw Terminal, Omron 2000 Series

**POWER CORD - MOLDED**

- Water Tight
- Factory Finished Look

PART NO.	DESCRIPTION
8.752-150.0	6' 14/3 with Plug

**RELAYS**



9.802-468.0



8.716-230.0



9.802-467.0



9.802-470.0



8.716-264.0



8.716-257.0

PART NO.	DESCRIPTION
9.802-468.0	Compact Relay with Light & Button- 10A, 120V, 4170 Ohms with indicator, DPDT, Socketable Mount RH2B UI AC120
8.716-209.0	Relay with Indicator Light- 10A, 24V AC, Midget, 153 Ohms, DPDT, Socketable Mount
9.802-467.0	Relay Socket/Base- 8 Pin, 2 Pole, 10A / 300V, DIN Rail Mount, M3.5 Screw, RH2B Series
8.716-230.0	Relay- 10A/24V AC, Midget, 153 Ohms, DPDT, Socketable Mount, RH2B
8.716-264.0	Power Relay-120V, Tab Mount, 30A SPST-NO-DM, 1/4" Terminals for SKHT-1X
8.716-257.0	Power Relay- 40A / 120V AC, SPDT, PCB/Chassis Mount
9.802-470.0	Mini Iso Relay- 40A / 12V, SPDT, for 12V DC Units, 13HP & Below
9.802-471.0	Mini Relay- 40A / 24V DC, SPDT, for 12V DC Units over 13HP

**CAM SWITCHES - ROTARY - SALZER**

- Single or Three Phase
- 2 Position or 3 Position
- Heavy-Duty



9.802-449.0

PART NO.	DESCRIPTION
9.802-450.0	2-Position 35A-115V/600V, 1-3 Phase
9.802-449.0	3-Position 115V / 230V, 1PH, 20 Amp
8.716-027.0	3-Position 230V / 460V, 3PH
8.716-030.0	Rotary Switch

## MOTOR CONTACTORS - COILS & THERMAL OVERLOADS

For pressure washer and car wash applications.

- 24V AC Control
- 10 - 240V, 30 - 240V or 480V Contractor
- Componentized for Flexibility
- Thermal overloads adjustable within range shown
- Electrical Life: 1,000,000 + Cycles
- Mechanical Life: 20,000,000 + Cycles
- Contacts: 90% Silver, 10% Cad-Oxide



Contactor



Coil



Thermal Overload

TYPE	24V COIL PART NO.	120V COIL PART NO.	230V COIL PART NO.	FL AMP	220V 10 HP	220V 30 HP	440V 30 HP
<b>CONTACTORS UL RATING</b>							
A	8.708-753.0	8.902-527.0	8.902-532.0	22	2	3	5
B	8.708-754.0	8.902-528.0	8.902-533.0	24	2	5	7.5
C	8.902-523.0	8.902-529.0	8.902-534.0	32	3	5	10
D	8.902-524.0	8.902-530.0	-	40	5	7.5	15
E	8.902-526.0	8.902-531.0	8.902-536.0	52	7.5	10	20

PART NO.	VOLTAGE	FITS CONTACTOR
<b>COILS ONLY</b>		
8.708-764.0	24v	A,B,C,D
8.708-765.0	480v	A,B,C,D
8.708-767.0	220v	E

PART NO.	TYPE	AMP RANGE	FITS CONTACTOR
<b>THERMAL OVERLOADS</b>			
8.708-749.0	Manual	9.0 - 15	A,B,C,D
8.708-760.0	Manual	17 - 26	A,B,C,D
8.708-742.0	Manual	20 - 33	C,D
8.708-744.0	Manual	28 - 42	C,D
8.708-750.0	Auto	9.0 - 15	A,B,C,D
8.708-759.0	Auto	14 - 23	A,B,C,D
8.708-743.0	Auto	20 - 33	C,D
8.708-747.0	Auto	35 - 50	E,F

- Used to Mount Overload to Motor Starter Contactors

PART NO.	FITS CONTACTOR
<b>RELAY CONNECTOR KIT</b>	
8.708-768.0	Relay Connector Kit 260265-268
	A,B,C,D

Specifications, product descriptions, product availability, and pricing subject to change without notice.

**TRANSFORMERS - STEP-DOWN**

■ Industrial Duty

■ High-Quality Cutler-Hammer

■ Drops primary voltage to selected secondary voltage



**8.716-899.0**



**9.802-553.0**



**8.716-904.0**

PART NO.	PRIMARY V	SECONDARY V	SIZE
<b>8.716-899.0</b>	380V/400V/415V	110/220V	.750KvA
<b>9.802-553.0</b>	120V/240V	24V	.050KvA
<b>8.716-904.0</b>	120V/240V	24V	.100KvA
<b>8.716-883.0</b>	208V/230V/460V	24V/115V	.050KvA
<b>9.804-556.0</b>	208V/277V	120V	.050KvA
<b>8.716-882.0</b>	208V/277V	120V	.075KvA
<b>9.803-971.0</b>	380V	24V	.050KvA
<b>9.802-550.0</b>	240V/480V	120V/240V	.500KvA
<b>9.802-552.0</b>	240V/480V	120V	.075KvA
<b>9.802-551.0</b>	240V/480V	120V	.050KvA
<b>9.803-668.0</b>	550V/575V/600V	115V	.050KVA

**MOTOR STARTER WITH SEALED BOX - MANUAL**

■ AMP: 25 with Adjustable Overload

■ Two-Cord Grip Fit 1/2" Threaded Knockouts

■ Adjustment Range AMPS: 20-25

■ Protective Cover Over Buttons

■ Sealed Box: 3-1/4" W x 3-1/2" D x 6-1/2" H

■ Single and 3-Phase Wiring Instructions

■ 110-500V IEC-Rated



PART NO.	DESCRIPTION
<b>8.709-709.0</b>	Motor Starter



## JUNCTION BOXES



PART NO.	DESCRIPTION
9.802-474.0	VNG Remote, Plastic
8.716-269.0	12" x 12" x 4", Metal VNG Remote Box
8.716-271.0	Fiberglass, NEMA1 for PE Units
8.716-272.0	12" x 10" x 5.25" for Solid Sep
9.802-475.0	8" x 8" x 4", Box, Plastic with Lid for SEA 3-1100
9.802-476.0	10" x 8" x 6", Box, Plastic with Lid for SEA
9.802-477.0	Box, Plastic without Lid E9081
9.802-478.0	Lid, Plastic for 9.802-477.0
8.716-280.0	18" x 16" x 9.25", Plastic for CLP, WB
8.716-281.0	14" x 16" x 6.75", Plastic for HBG, AMC
8.716-320.0	Cover, Duplex Receptacle for Alpha
8.716-321.0	2" x 4", 3-Hole, 1/2" WB, for CLP
8.716-322.0	2" x 4", Extension for 8.716-321.0, 8.716-323.0, 8.716-324.0
8.716-323.0	2" x 4", 5-Hole, 1/2" for CLP
8.716-324.0	2" x 4", 4-Hole, 1/2" for CLP
8.716-326.0	4" x 4", 3-Hole, SK Series for Alpha / PK
8.716-327.0	4" x 4", 5-Hole, 1/2" for WB
8.716-329.0	4" x 4" SK, Cover Plate for WB for 6-00041
9.802-483.0	2" x 4", Cover Plate for 8.716-321.0
9.802-484.0	2" x 4", Junction 3-Hole, 3/4"
8.716-339.0	2" x 4", 3-Hole, 1" for ENG

## SWITCH BOX - RAIN TITE

- UL 728A
- Box: 2-3/4" x 5-1/2" x 2"
- Three 1/2" Tapped Holes
- Box includes two plugs, ground screw and mounting lugs
- Cover Includes Gasket



PART NO.	DESCRIPTION
8.709-702.0	RainTite Switch Box

**TIMER**

- Preset and Adjustable Available
- 24-240V
- Heavy-Duty



PART NO.	DESCRIPTION
9.802-472.0	Solid State, 5-60 Min, 15 Sec with Lockout for Auto Start

**CIRCUIT BREAKERS**

- Provides protection against excessive Amp draw



PART NO.	DESCRIPTION
9.802-485.0	25 Amp (All 12V Systems)

**FUSES**

- Full range of fuses
- Protect your equipment



PART NO.	CODE	MAX V	AMPS
9.802-463.0	FNM1/2	250V	0.5
9.802-464.0	FNM8/10	250V	0.8
8.716-173.0	FNM1	250V	1.0
9.803-977.0	FNM2-1/2	250V	2.5
8.716-187.0	FNM3	250V	3.0
9.803-664.0	FNM5	250V	5.0
8.716-194.0	FNM7	250V	7.0
9.802-460.0	FNM8	250V	8.0
8.716-165.0	FNM10	250V	10.0
8.716-191.0	FNQ3/10	500V	0.3
8.716-192.0	FNQ6/10	500V	0.6
9.802-465.0	FNQ-R-3	600V	3.0
8.716-169.0	KTK-R1/4	600V	0.25
9.802-462.0	KTK-R1/2	480V	0.5
8.933-007.0	KTK-R1	240V	1.0
8.716-177.0	KTK-R1-1/2	600V	1.5
9.803-663.0	KTK-R2	120V	2.0
8.716-179.0	KTK-R2-1/2	600V	2.5
8.716-180.0	KTK-R4	600V	4.0
9.804-050.0	KTK-R5	600V	5.0
8.716-183.0	KTK-R30	600V	30.0
8.716-170.0	MDL1/2	120V	0.5
8.716-175.0	MDL3/4	250V	0.75
8.716-172.0	MDL1	250V	1.0
8.716-174.0	MDL2-1/2	24V	2.5
8.716-186.0	MDL3	250V	3.0
8.716-188.0	MDL5	250V	5.0
8.716-161.0	MDL7-1/2	250V	7.5

## CAM SWITCHES - 3-POSITION - MACHINE CONTROL

- Heavy-Duty Rotary Cam Switches
- Legend plate reads off / pump / burner
- Quick make / break action reduces arcing
- Wiring Boot Included (Except 410242-3)
- Legend Plate, 2/1/2" Square
- 4-Screw Mounting



PART NO.	MODEL	AMP RATING	VOLTAGE	PHASE
8.712-219.0*	S220-1686	20	110V	1
8.712-224.0*	S220-1687	20	220V	1
8.712-225.0*	S220-1688	20	220V	3
8.712-227.0*	S225-1686	30	110V	1
8.712-228.0*	S225-1687	30	220V	1
8.712-229.0*	S225-1688	30	220V	3
8.712-234.0	S432-4095	40	240V	1
8.712-235.0	S432-1402	40	480V	3
<b>SINGLE-HOLE MOUNTING - REQUIRES 1 22MM (7/8" DIA) HOLE</b>				
8.712-218.0	220-1789	20	110V	1
<b>*REPLACEMENT KNOB - FITS THOSE PART NUMBERS ABOVE MARKED WITH AN ASTERISK (*)</b>				
8.700-258.0	Replacement Knob			

## CAM SWITCHES WITH & WITHOUT BOX

Cam action fast "make-break" to reduce arcing.

- 40 - 60 Amp disconnect rating
- Four 1/2" Knock-Outs
- Versatile Mounting
- Motor Ratings:  
7.5 HP at 240V, Single Phase  
5.0 HP at 240V, 3 Phase  
30.0 HP at 480V, 3 Phase



PART NO.	DESCRIPTION
8.712-217.0	40 Amp Switch with Large Box 4-1/2" W x 7" H x 3-3/4" D
8.712-211.0	60A/600V, 4P, Salzer Switch Only, No Knob
8.712-212.0	Box Only 3-7/8" x 4-7/8" x 2-3/4" for 8.712-211.0, 60A Salzer Switch Using 10 Gage / Smaller Wire
8.700-489.0	Knob

Note: Switch does not have thermal overload protection

## CAM SWITCHES - 3-POSITION -SALZAR "BIG BOOT"

Large rectangular boot for easier wiring.

- Mounting configuration and electrical ratings same as "S" switches



PART NO.	MODEL	AMP RATING	VOLTAGE	PHASE
8.712-238.0	T225-1686	30	110V	1Ø
8.712-241.0	T225-1688	30	240V	3Ø
<b>SINGLE-HOLE MOUNTING - REQUIRES ONE 22 MM (7/8" DIA) HOLE</b>				
8.712-223.0	220-1843	20	220V	1Ø

### CAM SWITCHES - 3-POSITION - "ELEKTRA" UNIVERSAL

UL/CSA-rated machine control cam switches.

- Position "off" - "pump burner"
- Quick make / break action - reduces arcing
- 2 or 4 Screw Mount (2-1/2" Square Legend Plate)
- Matches Salzer / Kraus, Naimer / Bremas & Klockner, Moeller Mounts
- "Boot" has plenty of wiring room
- "Tite Boot" excellent dust and moisture seal
- Screw-to-screw, terminal-to-terminal replacement for Salzer "S" and "J" type switches above
- Contacts UL / CSA Rated: 24 Amp vs 20 Amp, 35 Amp vs 30 Amp, 50 Amp vs 40 Amp



8.712-236.0



8.712-237.0



8.712-240.0

PART NO.	AMP RATING	WIRING POLES	VOLTAGE	PHASE	HP RATING
8.712-236.0	25	1	120V	1	1.5
8.712-237.0	25	2	120V / 240V	1	1.5 / 2.0
8.712-240.0	35	2	120V / 240V	1	2.0 / 3.0
8.712-242.0	50	2	120V / 240V	1	3.0 / 7.5

Note: None of the Elektra switches are for use on 3-phase motors without adding fuses or thermal overload

### CAM SWITCHES - ON / OFF WITH BOX - "ELEKTRA"

UL/CSA-rated 25 and 35 Amp. Compact 3-1/4" square x 3-3/4" deep enclosure "versatile mount."



PART NO.	AMP RATING	WIRING POLES	VOLTAGE	PHASE	HP RATING
8.712-214.0	25	2	120V / 240V	1	1.5 / 2.0
8.712-216.0	35	2	120V / 240V	1	2.0 / 3.0

Note: None of the Elektra switches are for use on 3-phase motors without adding fuses or thermal overload

### ROCKER SWITCHES

2500 Watt, 120V, 21.6 Amp at 3,600 RPM

- On / Off, 2 & 3 Position
- Lighted Available
- 125V / 250V / 24V



9.802-453.0



8.716-051.0



9.802-451.0



9.802-452.0

PART NO.	DESCRIPTION	AMP	VOLTAGE
9.802-453.0	Curvette, SPST, 2-Pos, Carling	16 / 10	120V / 250V
8.716-051.0	Curvette, DPST, 2-Pos, Carling	20 / 15	125V / 250V
9.802-451.0	Carling, Green Light, 2-Pos	15 / 10	125V / 250V
9.802-452.0	Green Lamp, Red Actuator, 3-Pos	15 / 10	125V / 250V
8.716-037.0	Rocker Switch	15 / 10	125V / 250V / 24V

**GENERATOR - WINCO- AC- TB2400**

2400 Watt, 120 VT, 3600 RPM, 20 Amps.



- 13.3" L x 7.6" W x 8.1" H
- 33 lbs.
- Starts and Runs 1/2 HP Motor



- 7/8" diameter shaft
- Conforms to UL1004-1, UL1004-4 and CSA 22.2 No. 100-24

PART NO.	DESCRIPTION
8.757-639.0	TB2400 Generator

**THERMOSTAT - PROBE STYLE**

With panel-mount controls



- PSI: 4000
- Temperature change response within + 12°F
- Accuracy + 2.5%
- 120VAC-20A
- 240VAC-20A
- 120/240VAC-1/4HP
- Large, Easy-Read Dial
- 3-1/2" SS Capillary Copper Immersion bulb with 60" capillary tube. UL/CSA Approved
- Seal, nut and 1/2" transition coupling included

PART NO.	DESCRIPTION
8.758-149.0	86-302 Deg
8.758-180.0	86-195 Deg
8.758-181.0	86-250 Deg

**THERMOSTAT - ADJUSTABLE - FLOW-THRU**

- 8.904-555.0
- PSI: 3000
- Adjustable Temperature: 85° - 195°F
- AMP: 10, 110V
- AMP: 5, 220V
- 1/2" Inlet, 3/8" Outlet
- Fenwall Inside

PART NO.	DESCRIPTION
8.904-555.0	Thermostat
8.700-501.0	Switch Only

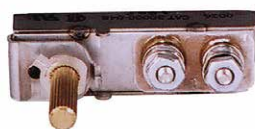

- 8.700-501.0
- Tension Adjusting Screw
- Stop Collar
- Ceramic Insulation
- Silver Contacts
- Stainless-Steel Case

**GENERATOR - VOLTMASTER**

2500 Watt, 120V, 21.6 Amp at 3,600 RPM



- 36.5 lbs.
- Brushless Design
- Circuit breaker protection (standard)
- 7/8" Shaft, Two Sealed (Ball) Bearings
- Shaft rotates either direction
- Industrial-Type Watertight Enclosure (11-5/8" x 7-1/2" Diameter)
- All Copper Windings, High Surge Capacity

PART NO.	DESCRIPTION
8.709-810.0	2500 Watt Generator

**DIGITAL POWER MONITOR**

Provides accurate testing and monitoring of electrical outlets and systems.



- Operating Temp: +32°F to +125°F
- Outlet: 120V/15A Single Phase
- Voltage Range: 85 - 150 Vac RMS
- Constantly monitors voltage and frequency indicated potential improper polarity and ground wiring
- Accurate testing and monitoring of all AC power sources
- RMS Voltage and Frequency Meter
- Multi-tone Fault Alarm
- Hands-Free Auto Reset
- Advanced Microelectronics
- One-Button Operation

PART NO.	DESCRIPTION
8.749-947.0	Digital Monitor

**CAM SWITCHES - 2-POSITION**

- Legend Plate: On / Off
- Tear-Drop-Shaped Knob
- Face Plate 2-1/2" Square
- Motor Ratings:  
410202 - 1-1/2 HP / 110V  
410204 - 6 HP / 240V

PART NO.	DESCRIPTION
8.712-213.0	25 Amp / 110V
8.712-215.0	30 Amp / 220V

**INDICATOR LIGHTS**



8.716-408.0 9.802-456.0

- Easy Mounts to Control Panel
- Available in 12V, 24V and 125V
- Great for remote applications

PART NO.	VOLTAGE	COLOR
8.716-095.0	125V	Red
9.802-455.0	125V	Green
8.716-408.0	125V	Amber
9.803-651.0	28V	Red
9.803-652.0	28V	Green
8.716-097.0	12V	Red
9.802-456.0	12V	Green

**BREAKER SWITCHES**



PART NO.	DESCRIPTION	PHASE
8.716-067.0	7.5 HP, 230V, 1400	1PH
8.716-068.0	7.5 HP, 230V, 1400	3PH
8.716-069.0	7.5 HP, 460V, 1400	3PH
8.716-073.0	10A / 460V, 900	3PH
8.716-074.0	12A / 480V	3PH
8.716-075.0	15A / 18.8V, 800	3PH
8.716-076.0	20A / 277V, 900	3PH
8.716-070.0	25A / 250V, 2255	3PH
8.716-077.0	30A / 277V, 900	1PH
8.716-066.0	40A / 230V, 1070	1PH

**WIRE LOOMS - USED FOR WIRING HARNESSES**



- Protects wires from abrasion and crushing
- Controls bundles of wires and allows for multiple exits at wiring points
- "Factory-perfect" look for all machines

PART NO.	DESCRIPTION
8.709-679.0	1/4" ID 100' Roll
8.709-680.0	3/8" ID 100' Roll
8.709-681.0	1/2" ID 100' Roll
8.709-682.0	5/8" ID 100' Roll

**GFCI MODULE**

Not recommended for field service.



- AMP: 20 at 120V or 240V, 60 Hz
- Using 120V or 240V shop attachable module; attach your power cord length as required
- Use with 16-12 gauge SJ, SJO or SJT, 3-wire cords

PART NO.	DESCRIPTION	PHASE
8.709-858.0	GFCI Module	1PH

**TAPE - VINYL ELECTRICAL**



- Premium Grade, 7 mil
- UL-Approved

PART NO.	DESCRIPTION
8.704-706.0	Roll 3/4" x 60'

**CONNECTOR CLAMPS - ROMEX (METAL)**



PART NO.	DESCRIPTION
8.709-663.0	1/2" Strt. Connector
8.709-664.0	3/4" Strt. Connector
8.709-660.0	1/2" Lock Nut Only
8.709-661.0	3/4" Lock Nut Only

**CORD CAPS & PLUGS**



- |  |                           |                           |  |
|--|---------------------------|---------------------------|--|
| <p><b>8.709-653.0</b></p> <ul style="list-style-type: none"> <li>■ Industrial-Quality</li> <li>■ Dead front cord caps - nylon body straight plugs and "auto-clamp" for cord</li> </ul> | <p><b>8.709-655.0</b></p> | <p><b>8.709-656.0</b></p> | <p><b>8.709-659.0</b></p> <ul style="list-style-type: none"> <li>■ 8.709-659.0 angle plug has vinyl body and both 30A and 50A neutral leg</li> </ul> |
|--|---------------------------|---------------------------|--|

PART NO.	DESCRIPTION	MATERIAL
8.709-653.0	15A / 125V	Black Nylon
8.709-655.0	20A / 125V	Black Nylon
8.709-656.0	20A / 220V	Black Nylon
8.753-905.0	30A-50A / 250V	Black Vinyl

## CONNECTOR / STRAIN RELIEFS - LIQUID TIGHT - FOR CABLE, WIRE & TUBING

Keep water-tight NEMA-4 and 4x enclosures water-tight with these unique fittings.

### DOME NUT WITH INSIDE TAPER

- As the dome nut is tightened, the seal ring grips, holding the cable wire or tubing positively in place.



### LEAD-SCREW THREAD

- The dome nut can be firmly tightened due to the high strength lead-screw thread.

### CLAMPING SPLINES

- Various sizes and odd-shaped cables, wires and tubing can be accommodated due to overlapping diagonally split clamping splines



PART NO.	TYPE	THREAD	CORD SIZE	CORD OD	LENGTH
9.802-514.0	Dome	1/2" NPT	14/3-12/3	.230" - .470"	1.8"
8.709-688.0	Dome	3/4" NPT	14/3-12/3	.350" - .630"	2.0"
8.709-689.0	Dome	3/4" NPT	12/3-10/4	.510" - .710"	2.0"
8.709-690.0	Flex	1/2" NPT	14/3-12/3	.230" - .470"	4.3"
8.709-692.0	Flex	3/4" NPT	12/3-10/4	.51" - .71"	5.2"

PART NO.	THREAD
<b>PLASTIC JAM NUTS</b>	
9.802-525.0	1/2" NPT
9.802-526.0	3/4" NPT

## GFCI - WITH AND WITHOUT PLUGS & CORDS

GFCIs protect people and equipment by interrupting potentially lethal ground circuits exceeding 6mA. The dangers of electrical shocks have been long known - GFCIs are the only real way to be safe. Most city and county codes now require GFCI protection on power cleaning equipment.

- UL-Listed
- Three Wire Circuits
- Transient Voltage Protection
- 4-6mA Ground Fault Protection
- Grounded Neutral Protection
- Mechanical Trip Indicator
- Compact Size
- Rugged Construction
- Radio Frequency Interference Suppression



Integrated GFI & Plug



PART NO.	VOLTAGE	AMP	LENGTH	INTEGRATED
<b>GFCI CORD WITHOUT PLUG</b>				
8.709-842.0	120V	20A	12'	N/A
8.709-860.0	240V	30A	6'	N/A
8.709-861.0	240V	30A	12'	N/A
8.709-862.0	240V	30A	35'	N/A
9.802-434.0	240V	40A	36'	N/A
<b>GFCI CORD WITH PLUG</b>				
8.709-850.0*	120V	15A	12'	Combo
9.802-432.0*	120V	15A	36'	Combo
8.709-843.0	120V	20A	37'	Separated
9.802-431.0*	120V	20A	36'	Combo
9.802-433.0	240V	20A	36'	Separated
8.709-853.0	240V	30A	6'	Separated
8.709-854.0	240V	30A	12'	Separated
8.709-855.0	240V	30A	35'	Separated
9.802-430.0	240V	30A	36'	Separated
<b>GFCI PLUG WITHOUT CORD</b>				
8.709-847.0	120V	15A	N/A	N/A
8.709-846.0	120V	20A	N/A	N/A

Note: User-attached plug also includes the sealant necessary to attach the power cord per UL specification

\* Integrated GFI & Plug

**MOLDED PLASTIC FLOAT TANKS**



- Molded Polypropylene
- 7 Liter Size: 13" x 5" x 6"
- 1 Gallon Size: 10" x 5" x 8"
- No Holes for Max Flexibility
- 1-Gallon Tank has Tight Fitting Lid (included)
- 7-Liter Snap-on Tank Lid (sold separately)

PART NO.	DESCRIPTION
8.710-026.0	7-Liter Tank Only
8.710-027.0	7-Liter Tank Lid
8.710-028.0	1-Gallon Tank with Lid

**STAINLESS-STEEL FLOAT TANK**



- Fully Welded and Water Tight
- 2.8 Gallon Capacity
- 12" x 9" x 6"
- 16 Gauge #303 Stainless-Steel
- 1/2" Full Coupling, Stainless-Steel Inlet / Outlet
- Convenient Mounting Tabs

PART NO.	DESCRIPTION
8.710-029.0	Stainless-Steel Float Tank
8.710-034.0	Stainless-Steel Lid

**FRAMES, DIRECT DRIVE**



- Heavy-duty Aluminium, More Corrosion-resistant than Steel
- 10" Flat-free Tire for Better Reliability
- Integrated Nozzle Holders

PART NO.	DESCRIPTION
8.924-399.0	Aluminium Frame, DD CW
8.924-400.0	Aluminium Frame, 270 and 390 AL DD CW

**REPLACEMENT FUEL CAP**

- Fits 9 Gallon Diesel Fuel Tank (8.710-142.0)
- Fits Fuel Tanks (8.751-294.0, 8.751-296.0, 8.751-293.0)

PART NO.	DESCRIPTION
8.751-449.0	Replacement Fuel Cap for Fuel Tanks

**FUEL TANK, 9-GALLON DIESEL**



- Strap or Bolt Mount (4 / 5/ 16" Inserts in Bottom)
- Metal Inset 3/8" Inlet / Return Lines
- Black, Crosslinked PE
- Vented Fuel Cap
- Filler Neck Doesn't Extend Beyond Tank Wall
- Compact Size: 19-3/4"L x 12"W x 10-1/2"H

PART NO.	DESCRIPTION
8.710-142.0	9-Gallon Fuel Tank - Plastic

Note: Includes Fuel Cap

**FUEL TANKS**



8.751-293.0

- EPA / CARB-Compliant
- Seamless One-piece Construction of Marine Grade, UV-protected Polyethylene
- 90° Fuel Withdrawal Fitting



8.751-294.0

- Two-stage Click when Closed Fuel Cap
- Built-in Reserve (when gauge reads "empty", tilt to access additional fuel)
- Easy-to-read Sight Gauge

PART NO.	SIZE	DIMENSIONS (LxWxH)
8.751-294.0	6-gal	21.18" x 13.5" x 10"
8.751-296.0	12-gal	20.375" x 13.75" x 14.75"
8.751-293.0	12-gal	24.25" x 18" x 11"



### RUBBER PARTS



PART NO.	DESCRIPTION
9.802-064.0	Grommet, Nozzle Holder
8.706-557.0	Bellows, Leg Boot
9.802-067.0	Bumper Pad, Engine
9.802-069.0	Handle Grip
8.706-745.0	Plug, Hole Plastic
9.803-046.0	Mount, Rubber Vibration
8.706-553.0	Mount, Rubber Vibration 60 Duro
8.706-524.0	Mount, Rubber Vibration 1-3/8" Dia x 3/4"
9.802-066.0	Pad, Soft Rubber

### FUEL CAPS



- For Gas or Diesel Fuel Tanks
- Fits Standard 2-1/4" Fuel Necks

PART NO.	DESCRIPTION
8.701-700.0	Fuel Cap with Gauge 10"

### BATTERY BOXES WITH COVER, MARINE STYLE

Protect batteries on pressure washers, boats or other industrial equipment.



- Attractive Molded Polypropylene
- Complete with hold-down cleats and strap for cover
- Small: 8-1/2"L x 6"W x 8-1/2"H
- Large: 11-1/4"L x 7-3/4"W x 10-3/4"H

PART NO.	DESCRIPTION
8.706-652.0	Small Box
8.706-600.0	Large Box

### FLAT-FREE TIRES

Flat-free tires provide the bounce and load handling characteristics similar to an air filled tire - with the benefit of never going flat. Flat-free tires are lightweight, non-marking and come mounted on a heavy-duty steel rim with shielded ball bearings. Not for highway use.



- Heavy-Duty Steel Rim
- Non-Marking
- 4" Steel Rim: Max Load 300 lbs.
- 12" Steel Rim: Max Load 375 lbs.
- Accepts .63" Shaft

PART NO.	DESCRIPTION
8.711-898.0	Wheel and Tire Assembly, 4" Steel Rim
8.758-460.0	Wheel and PU Tire Assembly, 12" Steel Rim

### PLASTIC DIP TUBE ASSEMBLY



- Rubber bushing seal (order separately)
- New Style Plastic Dip Tubes (order separately)

PART NO.	DESCRIPTION
8.706-494.0	Plastic Dip Tube Assembly, 7.5" Long
8.706-495.0	Plastic Dip Tube Assembly, 12" Long
8.706-496.0	Plastic Dip Tube Assembly, 17.75" Long
9.802-053.0	Rubber Bushing, Fuel Line

**COMPLETE WHEELS**



**8.711-901.0**



**8.754-186.0**



**8.712-762.0**

- High-Quality Pneumatic and Semi Pneumatic
- Fits 5/8" Shaft

PART NO.	DESCRIPTION
<b>8.711-901.0</b>	10" Mag
<b>8.754-186.0</b>	10" Steel Rim with Tube
<b>8.712-762.0</b>	10" White Steel Rim, 3/4" Hub Tubeless
<b>8.711-905.0</b>	6" Steel Rim Foam Filled
<b>8.711-921.0</b>	6" Tube Only
<b>8.712-767.0</b>	10" Tube Only
<b>9.802-274.0</b>	10" x 2-3/4" Hard Rubber Wheel
<b>8.711-908.0</b>	3" Gray Caster Wheel
<b>INTERCHANGEABLE BEARINGS</b>	
<b>8.700-484.0</b>	5/8" Bore Bearing
<b>8.700-486.0</b>	3/4" Bore Bearing
<b>8.700-485.0</b>	5/8" Nylon Bearing
<b>HUB CAPS AND COLLARS</b>	
<b>8.700-183.0</b>	3/4" Hub Cap
<b>8.700-184.0</b>	5/8" Hub Cap
<b>9.802-782.0</b>	5/8" Bore Shaft Collar



**8.700-486.0**



**8.700-485.0**

**MISCELLANEOUS PARTS**



**8.719-064.0**



**9.802-066.0**



**8.932-992.0**

PART NO.	DESCRIPTION
<b>8.719-064.0</b>	Chassis Knob 5/16" Thread, Black
<b>9.802-066.0</b>	Soft Rubber Foot Pad
<b>8.932-992.0</b>	Vibration Isolator 3/8"

**PUMP - AIR-OPERATED - FLOJET**

**FLOJET**



- Twin Diaphragm, Self-priming
- Dry Air (or CO2) PSI: 20-120
- GPM: 7.0
- Max Liquid Temperature: 120°F
- Santoprene Elastomers
- Self-Priming up to 15 Feet
- Air (Gas) In & Out, 1/4" Barb
- Choice of 3/8" or 1/2" Barb Fluid In/Out
- Automatic, On-Demand Start & Stop
- Flow Control via Air (Gas) Pressure
- Common Use: Chemical transfer and dispensing parts, washers and car wash systems

PART NO.	DESCRIPTION
8.702-321.0	3/8" Pump, Santoprene
8.702-322.0	3/8" Pump, Viton
8.702-323.0	1/2" Pump, Santoprene
8.702-324.0	1/2" Pump, Viton

**PUMPS - AIR-DRIVEN - FLOJET FLOJET**

Twin diaphragm, self-priming.



- Dry Air (or CO2) PSI: 20-80
- GPM: 1.9
- Max Liquid Temperature: 120°F
- Santoprene/Viton Elastomers: Use Santoprene for Soaps, Use Viton for Butyls
- Chemical In & Out, 3/8" Barb
- Air (Gas) In & Out, 1/4" Barb
- Automatic, On-demand Start & Stop
- Control Flow and Pressure with Air Pressure

PART NO.	DESCRIPTION
8.702-320.0	Pump, Santoprene
8.702-319.0	Pump, Viton
8.700-388.0	Valve Kit, Santoprene

**AIR-FILTER / REGULATORS**



8.712-585.0



8.712-586.0

- PSI: 125
- 1/4" Ports
- Pressure-Relieving
- Removes air line impurities to 5 microns
- Maintains and gauges pressure to, and therefore discharges pressure from, air-driven diaphragm pumps

PART NO.	DESCRIPTION
8.712-585.0	Regulator Only
8.712-586.0	Filter / Regulator
8.712-587.0	Gauge, 0-1 60, 1/8"

**BRUSHES - FOAM & ACCESSORIES**



**FOAM BRUSH**

- 3" x 10" super soft flagged bristle fountain brush. Choose from black, red or blue.



**FOAM BRUSH LANCE**

- 40" long with 30" insulated grip, 3/8" FPT inlet, 1/2" MPT outlet (matches brush inlet). Colors: red, blue or black.



**BRUSH HOSES**

- Clear, spiral wire braid, 1/2" ID with 3/8" MPT, zinc-plated steel fittings both ends.

PART NO.	DESCRIPTION
8.710-115.0	Foam Brush Head, Black
8.710-117.0	Foam Brush Head, Red
8.710-116.0	Foam Brush Head, Blue
8.710-119.0	Foam Hose, 15'
8.710-121.0	Lance 40", Red
8.710-122.0	Lance 40", Black
8.710-123.0	Lance 40", Blue

## CAR WASH BAY ACCESSORIES

### CAR WASH BOOMS, "REFLEX"

The performance leader!



- PSI: 3000
- 5' 6" Car Wash Model
- 8' Truck Wash Model
- Stainless-Steel Boom Arm
- 3/8" FPT Inlet / Outlet Hose (Included)

PART NO.	DESCRIPTION
<b>BOOMS</b>	
8.903-620.0	180° Wall Mount 5' 6" Boom
8.903-621.0	360° Ceiling Mount 5' 6" Boom
8.903-624.0	180° Wall Mount 10' Boom
8.903-625.0	360° Ceiling Mount 10' Boom
8.903-626.0	180° Wall Mount 8' Boom
8.903-627.0	360° Ceiling Mount 8' Boom
<b>PARTS / ACCESSORIES</b>	
8.903-622.0	5.5' Rod / Hose, Assy Only
8.903-623.0	8' Rod / Hose, Assy Only
8.903-628.0	10' Rod / Hose, Assy Only
8.903-630.0	Ceiling Mount, Base Only
8.903-632.0	Wall Mount, Base Only
8.700-265.0	Set Screw for Angle Block
8.905-605.0	90° End Coupler C/W Boom
8.905-604.0	8' Coupler Stainless-steel C/W Boom
8.712-450.0	Swivel - Brass 3/8"
8.700-263.0	Swivel Repair Kit (Pre-1998)
8.700-287.0	Swivel Repair Kit (1998-Present)

### WASH BAY ACCESSORIES - STAINLESS-STEEL

Foam brush broom holder, wand holders, mat clamps.

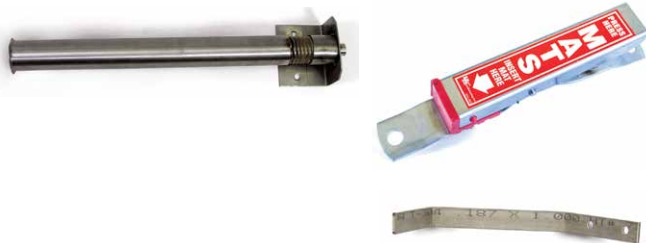

PART NO.	DESCRIPTION
8.708-880.0	Standard Foam Brush Holder
8.708-881.0	Rigid Wall Mount Wand Holder
8.708-882.0	Flex Bottom Mount Wand Holder
8.708-883.0	Mat Clamp

### LOCKS FOR METER BOXES



PART NO.	DESCRIPTION
8.708-730.0	Tubular Cam Lock

### SWITCH - ROTARY - 8-POSITION

Metal car wash switch.



- Double Stack 8-Position
- Metal
- Much more durable than cheaper plastic switches
- Direct replacement for Electroswitch 31302A-S and NU32LA
- Make before break functions

PART NO.	DESCRIPTION
8.708-729.0	8-Position Rotary Switch

### TRANSFORMERS



PART NO.	DESCRIPTION
8.708-780.0	115-24V AC: 600 MIL/AMP
8.708-781.0	115/208/230-24V AC: 100V A Fused
8.708-783.0	120/208/240-24V AC: 50V A
8.708-784.0	120/208/240-24V A Not Fused

### FUSES



PART NO.	DESCRIPTION
8.708-786.0	Transformer Fuse 5 AMP

**SWIVELS - MEDIUM-PRESSURE - CAR WASH**



- PSI: 1000
- 7/16" Flow-Thru Opening
- All-Brass Body
- Bronze-Thrust Bearing
- Buna Seals (Non-Repairable)
- 1/2" FPT x 1/2" MPT

PART NO.	DESCRIPTION
8.705-057.0	Swivel

**SWIVELS - LOW-PRESSURE - CAR WASH**



- Swivel Action PSI: 300
- Brass MPT
- Zinc-Chromate Steel FPT

PART NO.	DESCRIPTION
8.705-054.0	1/4" FPT x 1/4" MPT
8.705-056.0	3/8" FPT x 3/8" MPT
8.705-055.0	1/2" FPT x 1/2" MPT

**LANCES - FLEX**



- PSI: 2500
- Temperature: 200°F
- Flexes 180° and returns
- Prevents bent lances and broken hoses
- Industrial-grade polyurethane flex section
- Perfect for self-serve car wash bays
- 1/4" galvanized pipe end sections

PART NO.	LENGTH	DESCRIPTION
8.710-600.0	18"	1/4"MPT x 1/8"FPT, Black
8.710-601.0	18"	1/4"MPT x 1/8"FPT, Blue
8.710-603.0	21"	1/4"MPT x 1/8"FPT, Red
8.710-604.0	24"	1/4"MPT x 1/8"FPT, Red
8.710-598.0	18"	1/4"MPT x 1/4"MPT, Red

**VACUUM ACCESSORIES**

May slip directly on to hose. Use with swivel cuffs for better results.



**Vacuum Claw Nozzle**

PART NO.	COLOR
<b>1-1/2"</b>	
8.708-892.0	Yellow
8.708-891.0	Black
8.708-890.0	Gray
<b>2"</b>	
8.708-894.0	Yellow



**Adapter**

PART NO.	DESCRIPTION
8.708-900.0	2" Hose x 1-1/2" Wand
8.708-904.0	2" Hose x 2" Wand



**Cuffs, Hose to Tank**

PART NO.	DESCRIPTION
8.708-903.0	1-1/2" x 1-1/2"
8.708-904.0	2" x 2"
8.708-905.0	1-1/2" x 1-1/2" Swivel

**Vacuum Hose**

PART NO.	DESCRIPTION
8.697-112.0	50' Blue Vac hose 1-1/2" Swivel
8.697-117.0	50' Blue Vac hose, 2" Swivel

**TRIGGER GUN - RB65 WASH GUN**

Low-pressure spray gun with straight jet and adjustable cone from the trigger with adjustable screws to alter cone angle wideness from 0° to 60°.



- PSI: 350
- GPM: 16.0
- Temperature: 195°F
- Completely Sealed
- Ergonomic
- Adjustable Jet Cone
- Trigger Protection
- Brass Body

PART NO.	DESCRIPTION
8.710-449.0	PA RB65 with Swivel
8.710-448.0	PA RB65 No Swivel
9.114-478.0	PA RB65 Stainless Steel w/ Swivel (RED)
8.751-896.0	RB 65 Trigger Gun Seal Kit- KIT 2

**VACUUM MOTORS - A+ / AP**



**8.625-841.0**



**8.620-204.0**



**8.625-842.0**

PART NO.	DESCRIPTION
<b>TWO FAN STAGES, BYPASS MOTORS</b>	
<b>8.625-841.0</b>	5.7" Diameter, 120V Double Ball Bearing, Peripheral Discharge
<b>8.620-204.0</b>	Vault System Vac Motor: 120V Double Ball Bearings, Tangent Discharge
<b>THREE FAN STAGES, BYPASS MOTORS</b>	
<b>8.625-842.0</b>	5.7" Diameter, 120V Double Ball Bearings, Tangent Discharge

**VACUUM MOTORS - AMETEK-LAMB**



**8.685-502.0**



**8.685-442.0**



**8.685-458.0**

PART NO.	DESCRIPTION
<b>TWO FAN STAGES, BYPASS MOTORS</b>	
<b>8.685-502.0</b>	5.7" Diameter, 120V Double Ball Bearing, Peripheral Discharge
<b>8.685-442.0</b>	Vault System Vac Motor: 120V Double Ball Bearings, Tangent Discharge
<b>THREE FAN STAGES, BYPASS MOTORS</b>	
<b>8.685-458.0</b>	5.7" Diameter, 120V Double Ball Bearings, Tangent Discharge

**HOSES - CONNECTOR / CAR WASH BAY, 12'-25'**

All car wash bay hoses come with solid male pipe on both ends.



PART NO.	LENGTH	PSI
<b>3/8" BLACK - 1 WIRE</b>		
<b>8.918-333.0</b>	12'	4000
<b>8.918-334.0</b>	13'	4000
<b>8.918-338.0</b>	15'	4000
<b>8.918-340.0</b>	16'	4000
<b>8.918-342.0</b>	17'	4000
<b>8.918-344.0</b>	18'	4000
<b>8.918-348.0</b>	20'	4000
<b>3/8" BLUE - 1 WIRE</b>		
<b>8.918-360.0</b>	12'	3000
<b>8.918-362.0</b>	13'	3000
<b>8.918-366.0</b>	15'	3000
<b>8.919-124.0</b>	16'	3000
<b>8.918-369.0</b>	17'	3000
<b>8.918-371.0</b>	18'	3000
<b>8.918-373.0</b>	19'	3000
<b>8.918-375.0</b>	20'	3000
<b>8.918-385.0</b>	25'	3000
<b>1/4"BLUE - 1 WIRE</b>		
<b>8.918-387.0</b>	12'	3000
<b>8.918-389.0</b>	13'	3000
<b>8.918-391.0</b>	14'	3000
<b>8.918-393.0</b>	15'	3000
<b>8.918-395.0</b>	16'	3000
<b>8.918-397.0</b>	17'	3000
<b>8.918-399.0</b>	18'	3000
<b>8.918-401.0</b>	19'	3000
<b>8.918-403.0</b>	20'	3000
<b>8.918-409.0</b>	23'	3000
<b>8.918-411.0</b>	24'	3000
<b>8.918-413.0</b>	25'	3000

**SOLENOID VALVES - CFA - SS & BRASS**



- Air
- Light Oil
- Professional Car Washes
- Chemicals
- Low Pressure Steam
- Other Industrial Applications

**WATER SOLENOID VALVES 2-WAY, NORMALLY CLOSED.**



The S211 Series Standard Water Valves have reliable piloted diaphragm construction with proven performance over decades of use. Featuring stainless-steel seats, the S211 Series typically requires 4 or 5 PSI pressure differential to open. The S201 Series Zero Differential Valves are constructed with the

same materials, but are capable of operating with the same amount of pressure on both sides of the valve. Both valve types are often utilized in the car wash industry.

**CHEMICAL SOLENOID VALVES, 2-WAY, NORMALLY CLOSED.**



For decades, car wash industry professionals have chosen the rugged S301 and S311 Series Valves because of their compact size and long life. Available in 1/8", 1/4" and 3/8" NPT designs, these valves are used in air, water and chemical applications.

**HIGH-PRESSURE SOLENOID VALVES 2-WAY, NORMALLY CLOSED.**



The S401 High-Pressure Valves are compact, dependable and specifically designed by ITT to meet car wash applications up to 1400 PSI. Best Buy.

**SOLENOID VALVES FOR CAR WASH ANTI-FREEZE APPLICATIONS, NORMALLY OPEN**

These valves provide long life and reliable performance in the "make or break" anti-freeze systems of car washes. The S202 and S212 Series Diaphragm Valves feature non-wicking, fabric-reinforced diaphragms, which eliminates premature diaphragm failures, as well as stainless-steel upper seats, which prevents seat deterioration often associated with brass-seated valves. The S202 Series Diaphragm Valve incorporates the zero-operating pressure design discussed above; the S212 Series is a piloted diaphragm, and the S402 Series is piloted piston valve.

**SOLENOID VALVES - CFA - SS & BRASS**



<b>BODY</b>	<b>SEALS</b>	<b>MODE</b>	<b>TYPE</b>
BR = Brass	B = Buna	N/O = Normally Open	DA = Direct Acting
SS = Stainless-Steel	V = Viton	N/C = Normally Closed	PP = Piloted Piston
			PD = Piloted Diaphragm

PART NO.	GC PART NO.	PORT F-NPT / BODY	ORIFICE	OPER PSI	SEALS	MODE	TYPE / AC VOLTS	DEMA EQUIV
8.708-806.0	S201-CG4	3/8" / BR	.312"	150	B	N/C	PD / 110	A413P-110
8.708-807.0	S201-DG4	1/2" / BR	.438"	150	B	N/C	PD / 24	A414P-24
8.708-808.0	S201-DG4	1/2" / BR	.438"	150	B	N/C	PD / 110	A414P-110
8.708-821.0	S211-CG4	3/8" / BR	.625"	150	B	N/C	PD / 110	473P-110
8.708-822.0	S211-DG4	1/2" / BR	.625"	150	B	N/C	PD / 24	474P-24
8.708-823.0	S211-DG4	1/2" / BR	.625"	150	B	N/C	PD / 110	474P-110
8.708-824.0	S211-EG5	3/4" / BR	.750"	150	B	N/C	PD / 24	476P-24
8.708-825.0	S211-EG5	3/4" / BR	.750"	150	B	N/C	PD / 110	476P-110
8.708-826.0	S211-FG9	1" / BR	1.00"	150	B	N/C	PD / 24	-
8.708-827.0	S211-FG9	1" / BR	1.00"	150	B	N/C	PD / 110	-
8.708-829.0	S301-BD7	1/4" / BR	.109"	150	B	N/C	DA / 24	401P-24
8.708-830.0	S301-BD7	1/4" / BR	.109"	150	B	N/C	DA / 110	401P-110
8.708-816.0	S202-DG4	1/2" / BR	.438"	150	B	N/O	PD / 24	0A414P-24
8.708-831.0	S301-BD7	1/4" / SS	.125"	150	V	N/C	DA / 24	424-2-24
8.708-832.0	S301-BD7	1/4" / SS	.125"	150	V	N/C	DA / 110	424-2-110
8.708-833.0	S401-Z	3/8" / SS	.350"	1200	V	N/C	PP / 24	453P-24
8.708-834.0	S401-Z	3/8" / SS	.350"	1200	V	N/C	PP / 110	453P-110
8.708-835.0	S401-Z	1/2" / SS	.500"	1200	V	N/C	PP / 24	454P-24
8.708-836.0	S401-Z	1/2" / SS	.500"	1200	V	N/C	PP / 110	454P-110

**REPLACEMENT / REPAIR KITS FOR SOLENOID VALVES**

8.708-837.0	24V AC Coil
8.700-217.0	Repair Kit - S301, 1/4" Valves (Viton)
8.700-220.0	Repair Kit - S211, 3/4" Valves (Buna)

## SOLENOID VALVES - KIP - SS & BRASS

- Reliable over years of use
- Millions of cycles life not unusual
- All with FPT Ports



8.708-846.0



8.708-849.0



8.708-863.0

**MODE**  
**N/O** = Normally Open  
**N/C** = Normally Closed

**TYPE**  
**N/A** = Not Adjustable  
**C/A** = Chemical Adjustment

PART NO.	MODE	FPT	VOLTAGE	TYPE	ORIFICE ID
<b>STAINLESS-STEEL</b>					
8.708-846.0**	N/C	1/4"	24V AC	N/A	.062
8.708-849.0	N/C	1/8"	24V AC	N/A	.062
8.708-851.0	N/C	1/4"	24V AC	C/A	
8.708-852.0*	N/C	1/4"	24V AC	C/A	
8.708-855.0	N/C	1/4"	120V AC	N/A	.093
8.708-856.0	N/C	1/4"	24V AC	N/A	.093
8.708-857.0*	N/C	1/4"	120V AC	N/A	.093
8.708-858.0*	N/C	1/4"	24V AC	N/A	.093
<b>BRASS SOLENOID VALVES - KIP</b>					
8.708-863.0*	N/C	1/8"	240V AC	N/A	.062
8.708-864.0*	N/C	1/8"	120V AC	N/A	.062
<b>PARTS</b>					
8.708-859.0	Coil Only		120V	Wire Leads	
8.708-860.0	Coil Only		24V	Wire Leads	

\*Conduit Body Style with Wire Leads    \*\* Wire Leads

## SOLENOID VALVES WITH BUILT-IN STRAINERS

For pressure lines and pressure systems only.

### BRASS VALVES - DIAPHRAGM STYLE

- Normally close valve operation
- Proven design features for reliable performance on all applications
- Operates in any position, but do NOT mount valve with coil under valve
- Rated to 200°F fluid and 120°F ambient

### CELCON PLASTIC VALVES - SUPER FOR STRONG CHEMICALS

- PSI: 125
- Temperature: 180°F
- 1/4" & 3/8" FPT, 1/4" Orifice
- Diaphragm style with Y-screen (S.S.)
- Molded coil CSA-approved
- Compact design - 1/4" spade connects
- Normally closed operation



PART NO.	DEMA NO.	FPT	ORIFICE	PSI	VOLTAGE
<b>BRASS VALVES - DIAPHRAGM STYLE</b>					
8.711-249.0	442P	1/4"	.25	125	24V AC
8.711-250.0	442P	1/4"	.25	125	110V AC
8.711-252.0	443P	3/8"	.25	125	24V AC
<b>CELCON PLASTIC VALVES</b>					
8.708-869.0	P442	1/4"	.25	125	24V AC
8.708-870.0	P442	1/4"	.25	125	110V AC
8.708-871.0	P442	1/4"	.25	125	12V AC
8.708-872.0	P443	3/8"	.25	125	24V AC





## PROPORTIONER FLOAT VALVE SYSTEMS - AQUA MASTER™ MODEL 440

Liquid level proportioning controls - automatically maintain drum level and chemical concentration. The Aqua Master automatically maintains a desired level of proportioned mixture in a drum, tank or other type reservoir.



Magnetically activated "snap acting" float valves provide full water flow to activate the chemical proportioners. There are two basic sizes to give a choice of water flows as shown in the table below. Chemical feed rate is adjusted by metering screw or threaded metering tips. The compact 440 float valve is made of Celcon® plastic and is easily accessible for field maintenance.

Liquid-level proportioning controls are available in two flow capacities, 4.0 and 22.0 GPM at 50 PSI. Either size can be used with or without a proportioner. The proportioner allows chemical to be inducted while the valve is open.

All models, except as noted, are equipped with siphon breakers to prevent backflow into the fresh water line. The proportioner discharge is provided with means for attaching a hose or piece for under water feeding to minimize sudsing.

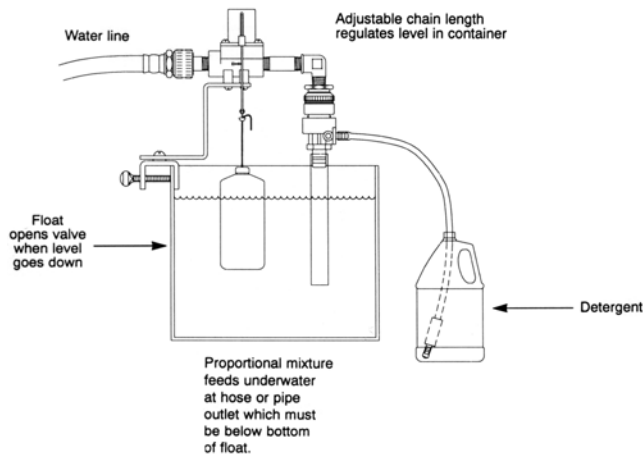

MODEL	DESCRIPTION	CAPACITY
440-23BT	Proportioning Valve, 4 GPM Flow at 50 PSI, Medium Capacity	12*
440-23T	Proportioning Valve, 4 GPM Flow at 50 PSI, High Capacity	35*
440-24	Proportioning Valve, 4 GPM Flow at 50 PSI, Highest Capacity	70*
437-21	Proportioning Valve, 22 GPM Flow at 50 PSI, Medium Capacity	10*

\*Oz. / Gal of 1 CPS Fluid (ie, Viscosity of Water)

PART NO.	DESCRIPTION
8.710-525.0	440-23BT
8.710-524.0	440-23T
8.710-526.0	440-24
8.710-534.0	Optional Tips

## VALVE - 3-WAY - ERIE MOTORTROL®



- Three-way valve to switch hot and cold inlets to single outlet
- 1/2" MPT (all three)
- 24V AC

PART NO.	DESCRIPTION
8.708-879.0	Motortrol Valve

## PROPORTIONERS & ACCESSORIES - DEMA

Designed to blend liquid chemical concentrates with water (flowing at normal city water pressure) to create an accurate mix of diluted chemicals. Complete with metering orifice set and/or metering adjustment valve.



- 1 CPS = Viscosity of Water
- 75 CPS = Viscosity of SAE 10 Oil
- 220 CPS = Viscosity of SAE 30 Oil

MODEL NO.	DESCRIPTION	CAPACITY
Max Blend Rate = Oz. Chem Per Gal Water		
	<b>1 CPS</b>	<b>75 CPS</b> <b>220 CPS</b>
162	24	14      6
163H*	64	30      14

\*High-concentration chemical blender

PART NO.	DESCRIPTION
8.710-530.0	#162 Drum Mount with Proportioner
8.710-529.0	#163H High Concentrate Proportioner Low Side
8.700-226.0	Polypropylene Foot Valve
8.710-534.0	Optional Tips

## HYPRO ROLLER PUMPS

Ideal for farm sprayers, pest control and chemical application usage.



- Maximum Fluid Temperature: 140°F
- Self-Priming Operation: Roller Pumps Should Not be Run Dry
- Adaptable to PTOs or Gas Engines
- Standard Super Rollers Provide the Chemical Resistance of Nylon and Long Life of Polypropylene
- Rotation is Determined by Looking at Shaft End of Pump



PART NO.	MODEL NO.	HOUSING	ROTATION	SHAFT DIA	NO. OF ROLLERS	SEALS
8.702-281.0	4101C	Cast-Iron	CW	5/8"	4	Viton
8.702-261.0	6500C	Cast-Iron	CCW	5/8"	6	Viton
8.702-263.0	6500C-R	Cast-Iron	CW	5/8"	6	Viton
8.702-282.0	7560C	Cast-Iron	CCW	15/16"	8	Viton
8.702-283.0	7560C-R	Cast-Iron	CW	15/16"	8	Viton

## PERFORMANCE TABLES



### SERIES 4001

- PSI Max: 150
- GPM Max: 9.0
- RPM Max: 1,800

PRESSURE IN PSI	GPM @ 1,100 RPM	HP	GPM @ 1,400 RPM	HP	GPM @ 1,800 RPM	HP
50	4.4	.24	5.9	.32	8.0	.46
100	3.8	.41	5.3	.56	7.3	.78
125	3.5	.50	5.0	.68	7.0	.95
150	3.3	.62	4.8	.78	6.7	1.10

### SERIES 6500

- PSI Max: 300
- GPM Max: 21.8
- RPM Max: 1,200

PRESSURE IN PSI	GPM @ 540 RPM	HP	GPM @ 1,000 RPM	HP	GPM @ 1,200 RPM	HP
50	8.0	.38	16.5	.71	20.1	.90
100	7.2	.68	15.4	1.26	19.1	1.51
125	5.6	1.29	14.0	2.34	17.3	2.84
150	4.3	1.91	12.7	3.47	15.7	4.17

### SERIES 4101

- PSI Max: 150
- GPM Max: 7.0
- RPM Max: 2,600

PRESSURE IN PSI	GPM @ 1,800 RPM	HP	GPM @ 2,200 RPM	HP	GPM @ 2,600 RPM	HP
50	4.5	.34	5.60	.40	6.6	.46
100	3.9	.56	5.0	.68	6.0	.76
125	3.7	.68	.82	.82	5.7	.92
150	3.4	.78	4.40	.96	5.4	1.08

### SERIES 7560

- PSI Max: 300
- GPM Max: 22.5
- RPM Max: 1,000

PRESSURE IN PSI	GPM @ 540 RPM	HP	GPM @ 800 RPM	HP	GPM @ 1,000 RPM	HP
50	11.1	.74	17.5	1.26	22.0	1.78
100	10.3	1.25	16.9	1.95	21.3	2.53
125	8.6	2.26	15.5	3.40	20.0	4.20
150	7.1	3.30	18.9	5.30	18.0	6.10

## FLOJET DIAPHRAGM PUMP

**FLOJET**

Built-in pressure switch automatically starts and stops pump instantaneously.



- Can run dry without damage
- Excellent Self-Priming Capability
- Low-Current Draw

PART NO.	FLOJET MODEL NO.	VOLTAGE	GPM	MAX PSI	PORTS	DIAPHRAGM*	VALVES*
8.702-328.0	4300-142A	12V DC	3.50	40	1/2" Barb	S	E
8.702-312.0	2100-032	115V	1.85	50	3/8" FPT	S	S
8.702-337.0	2100-022A	115V	1.85	50	3/8" FPT	V	V
8.702-331.0	4300-042	115V	3.50	45	1/2" Barb	S	E
8.702-329.0	4300-043A	115V	4.70	35	1/2" Barb	S	E

\*V = Viton E = EPDM S = Santoprene

Note: These units are designed to withstand many harsh chemicals. However, because compounds and concentrations of materials pumped through these units are beyond the manufacturer's control, the manufacturer DOES NOT PROVIDE A WARRANTY on the wet-end of the pump.

## DIAPHRAGM PUMP UNITS

**SHURflo**  
A WOOD GROUP COMPANY

1.0 - 3.8 GPM integrated pump motor units. Powered by 12V DC or 115V AC power. Pumps are standard with Santoprene® diaphragms and Viton valves for excellent service with a wide variety of sprayable products.

NOTE: Flow is reduced as pressure is increased (i.e. 100580 pumps 1.12 GPM at 60 PSI) automatic demand control on/off.



- Chemical-Resistant Materials
- Can run dry without damage
- Self-Priming
- Low-Amp Draw
- Automatic demand pressure switch or interanl bypass

PART NO.	SHURFLO MODEL NO.	POWER	VOLTAGE	GPM	MAX PSI	PORTS	DIAPHRAGM*	VALVES*
8.702-294.0	8000-541-236	Demand	12V DC	1.0	60	3/8" FPT	S	V
8.702-304.0	8000-343-236	Demand	12V DC	1.2	60	3/8" FPT	V	V
8.702-300.0	8000-543-236	Demand	12V DC	1.4	60	3/8" FPT	S	V
8.702-296.0	8000-543-238	Demand	12V DC	1.6	100	3/8" FPT	S	V
8.702-335.0	8030-813-239	Demand	12V DC	1.5	150	3/8" FPT	S	V
8.702-302.0	8002-793-238	Demand	12V DC	1.7	100	3/8" FPT	S	E
8.702-311.0	8000-532-256	Demand	115V	1.4	60	3/8" FPT	S	V
8.702-307.0	8000-033-236	Demand	115V	1.0	60	3/8" FPT	V	V
8.702-306.0	8000-533-236	Demand	115V	0.98	60	3/8" FPT	S	V
8.702-334.0	8000-812-288	Bypass	115V	1.4	100	3/8" FPT	S	V
8.702-308.0	8000-813-238	Demand	115V	1.6	100	3/8" FPT	S	V
8.702-338.0	8000-713-238	Demand	115V	1.6	100	3/8" FPT	S	E

### 2088 PREMIUM SERIES - SELF-PRIMES UP TO 12 FT. - BUILT-IN BACK CHECK

8.702-305.0	2088-343-135	Demand	12V DC	3.0	45	1/2" - 14M	S	V
8.702-303.0	2088-313-145	Demand	12V DC	3.6	45	1/2" - 14M	S	V
8.702-301.0	2088-712-244	Demand	12V DC	3.8	40	1/2" - 14M	S	E
8.702-310.0	2088-394-154	Demand	115V	3.2	40	1/2" - 14M	S	V

### 4111 - DOUBLE HEAD

8.702-339.0	4111-035	Demand	12V	7.0	45	1/2" - 14M	S	V
-------------	----------	--------	-----	-----	----	------------	---	---

### 166 - AIR DRIVE

8.702-317.0	166-200-56	Demand	AIR	1.25	65	3/8" Barb	E	E
-------------	------------	--------	-----	------	----	-----------	---	---

\*V = Viton E = EPDM S = Santoprene

Note: These units are designed to withstand many harsh chemicals. However, because compounds and concentrations of materials pumped through these units are beyond the manufacturer's control, the manufacturer DOES NOT PROVIDE A WARRANTY on the wet-end of the pump.

Specifications, product descriptions, product availability, and pricing subject to change without notice.

## AQUATEC 550 SERIES DIAPHRAGM PUMP

These pumps can either be controlled by a pressure switch ("demand" mode) or an external power control device. When required, an integrated bypass can be incorporated to help regulate pressure levels.



- Powerful flow rates up to 5.5 GPM / 21 LPM at pressures up to 80 PSI / 5.5 Bar
- Patented 5-Chamber diaphragm and piston design
- Quiet noise levels and with minimal pulsations

PART NO.	AQUATEC MODEL NO.	VOLTAGE	MAX FLOW	MAX PSI	PORTS	DIAPHRAGM*	VALVES*
8.750-812.0	25513-1E11-M638	12V DC	5.3	60	1/2" NPT	S	E

\*V = Viton E = EPDM S = Santoprene

## TWIN-DIAPHRAGM SPOT SPRAY PUMP



- PSI: 35 (#8 Tip)
- GPM: 1.0 (Open)
- 3/8" Hose Barb Inlet / Outlet
- Self-Priming to 2.5 Feet
- Operating Temperature: 40° - 110°F
- Liquid Temperature Max: 110°F
- 5 Amp Fuse
- Dry Weight: 1.3 lbs.
- Chemical-Resistant Valves and Diaphragm
- Compact automatic on-demand operation
- Sealed pressure switch automatically stops pump when discharge valve opens and closes
- Self-priming so pump can be located above supply tank
- Can run dry for extended periods without damage
- Built-In Thermal Protection on 12V DC Motor
- Low-Amp Draw (2.5 at 25 PSI, 4.0 at 35 PSI)

PART NO.	DESCRIPTION	OPEN
8.702-326.0	Spot Spray Pump, Max 35 PSI, 12V DC	1.0

## INDUSTRIAL CHEMICAL SPRAYER

Excellent pre-prep chemical applicator. Trigger control, demand flow, wall-mount cabinet, enclosed pump unit pulls chemical from a bulk tank and delivers it through 100' lightweight hose for low-pressure stream / cone or mist application. Operator simply squeezes trigger for instant application.



- Diaphragm Pump Units
- PSI: 60
- Choice of 12V DC or 110V DC
- 100-Foot Hose
- Adjustable nozzle for cone mist to straight stream
- Durable Santoprene and Viton-Wetted Parts

PART NO.	DESCRIPTION	MOTOR	PSI	GPM
<b>WALL MOUNT / CABINET SPRAYER</b>				
8.906-090.0	Chemical Applicator	115V AC	60	1.15
8.906-089.0	Chemical Applicator	12V DC	60	1.25

Note: These units are designed to withstand many harsh chemicals. However, because compounds and concentrations of materials pumped through these units are beyond the manufacturer's control, the manufacturer DOES NOT PROVIDE A WARRANTY on the wet-end of the pump.

## SPRAYMAX TRIGGER GUN

For pest control applications.



- PSI: 1000
- Temperature: 200°F
- Compare to JD-9, Mag-1, Robco and Ges
- Adjusts from fine mist to straight stream
- Drip-Free Shutoff
- Crafted for all-day comfortable use
- Larger trigger for 4-fingered grip

PART NO.	DESCRIPTION
8.708-995.0	With 1/2" Inlet
8.709-028.0	Repair Kit

## M23 TRIGGER VALVES

Versatile hand-held trigger valves for chemical or water-flow control.



- PSI: 700
- GPM: 18.5
- 1/2" FPT Inlet/Outlet
- Lock-On Trigger Loop

PART NO.	DESCRIPTION
<b>ALUMINUM BODY - SS / BR VALVE</b>	
8.708-982.0	Trigger Valve - Viton
<b>PLASTIC BODY - SS / BR VALVE</b>	
8.708-983.0	Trigger Valve - Viton
8.708-984.0	Trigger Valve - Buna

## TRIGGER-CONTROL SPRAY LANCES

Excellent for low-pressure chemical applications up to 150 PSI. Available in either plastic- or brass-lance tube. Works well with neutral, alkaline or mild acid solutions.



- Steel Trigger and Service Wrench
- Plastic Valve Body
- Brass-Needle Plunger
- Filter Screen in Nozzle Housing
- Cone Nozzle Adjusts 0-80°
- 24" Lance - Brass or Plastic
- Standard 11/16" outlet thread for standard low-pressure nozzle
- Accepts the adjustable cone nozzles or standard tip-jet nozzles (11/16 nozzle thread)

PART NO.	DESCRIPTION	
<b>TRIGGER LANCE</b>		
8.902-777.0	Brass without Nozzle	
8.902-778.0	Plastic without Nozzle	
8.708-977.0	Plastic with Red Nozzle	
8.925-822.0	Brass with Red Nozzle	
8.700-493.0	Needle Valve and Seal Kit	
PART NO.	DESCRIPTION	80° STRAIGHT CONE
<b>ADJUSTABLE NOZZLE - GPM @ 40 PSI / ADJUST 0-80°</b>		
8.708-980.0	#2 Red	.545 .204

## TURBINE SERIES GUNS

Forged-brass housings, stainless-steel lances, mist cone to straight stream adjustment, on/off control, lock-on trigger, 1/2" BSP inlet Viton seals, up to 850 PSI at 140°F.



- PSI: 850
- 1/2" BSP Male Inlet
- Weight: 4 lbs.
- Standard 15 x 1 LRT(4.5 mm)
- 62 ft - Reach, Straight Stream at 850 PSI, 31.5 ft - Reach, Full Cone at 850 PSI

PART NO.	DESCRIPTION	GPM	BARREL
8.708-990.0	Long Range Turbine	30	21
8.708-989.0	Turbine	25	17

## GUN ASSEMBLY - 910 SPOT SPRAY

High-pressure trigger gun adapted to spot spray application.



- Durable and comfortable
- 12" Plated Steel Lance
- 1/4" Hose Barb Inlet
- #2 Blue Adjustable Nozzle

PART NO.	DESCRIPTION
8.904-088.0	910 Spot Spray Gun Assembly

## BRASS PRESSURE REGULATOR



- Durable and Strong
- 3/4" FPT Outlet
- Temperature: 120°F
- Weight: 10.3 oz.
- Sprayers pumping up to 15 GPM
- Adjustable Pressure Ranges
- Stainless-Steel Spring
- Tee-Handle Adjustment Screw
- 3/4" MPT Inlet
- Knurled locknut for ease of locking in adjustment

PART NO.	DESCRIPTION	PSI
8.712-557.0	3/4" FPT Outlet x 3/4" MPT Inlet	0-300
8.712-558.0	3/4" FPT Outlet x 3/4" MPT Inlet	300-700

## HEAVY-DUTY SWIVELS

Live swivels help prevent twisted and tangled hose.



8.708-996.0

- PSI: 600
- Brass Body, Stainless-Steel Bolt
- Viton Seals
- 1/2" MPT inlet and 1/2" outlet

PART NO.	DESCRIPTION	PSI
8.708-996.0	Swivel 1/2" M x F	600
8.708-997.0	Swivel 3/4" M X F	600

## TRIGGER-JET SPRAY LANCES - TEEJET

Low-pressure chemical application lance will tolerate mild acid solutions.



- PSI: 150
- Diaphragm Shut-Off Valve
- Hand-Grip Trigger Control
- Plastic lance tube resistant to acids and agricultural chemicals
- Excellent for mild acids or alkali chemicals
- Polypropylene Body EPDM Seals STD
- 11/16" - Nozzle Connect Outlet

PART NO.	DESCRIPTION
----------	-------------

TRIGGER LANCE (TIP NOT INCLUDED)	
----------------------------------	--

8.709-182.0	24", 1/4" FPT Inlet, Viton
8.709-184.0	24", 3/8" HB Inlet, Viton

TRIGGER VALVE ONLY	
--------------------	--

8.709-185.0	3/8" HB Inlet, 11/16" Outlet, Viton
8.709-186.0	1/4" HB Inlet, 11/16" Outlet, Viton
8.709-187.0	1/4" FPT Inlet, 11/16" Outlet, Viton

PARTS AND ACCESSORIES - TRIGGER JET LANCE	
---	--

8.709-188.0	Adapter, 11/16" x 11/16" PP
8.709-189.0	24" Lance Tube Only
8.709-190.0	24" Lance Tube with Seals and Fittings

TIGGER JET NOZZLES - POLYPROPYLENE, ADJUST FROM 00 TO 600	
---	--

8.709-192.0	Yellow Core (x 3), .23 GPM / 60 PSI
8.709-193.0	Green Core (x 5), .37 GPM / 60 PSI
8.709-194.0	Red Core (x 6), .45 GPM / 60 PSI
8.709-195.0	Gray Core (x 8), .57 GPM / 60 PSI
8.709-196.0	Brown Core (x 12), .84 GPM / 60 PSI
8.709-197.0	Orange Core (x 18), 1.2 GPM / 60 PSI

## LONG RANGE TIP

Best used with long-range turbine gun.



- PSI: 850
- GPM: 24.4
- 15 x 1 Long-Range Tip
- Brass Body
- 77 ft Max Throw Range

PART NO.	ORIFICE DIA (MM)	DEGREES
----------	------------------	---------

8.708-998.0	3.5	45°
8.708-999.0	4.0	45°
8.709-000.0	4.5	50°
8.709-001.0	5.0	55°
8.709-002.0	5.5	60°
8.709-003.0	6.0	65°
8.709-004.0	7.0	75°

## LOW-FLOW BRASS PRESSURE REGULATOR



- 1/2" MPT Inlet
- 1/2" Outlet
- Temperature: 120°F
- Weight: 10.3 oz.
- For Sprayers Pumping Up to 5 GPM
- Durable and Strong Brass Construction
- Stainless-Steel Spring
- Positive Viton Seal to Prevent Leakage
- Knurled Locknut for Easy Adjustment

PART NO.	DESCRIPTION
----------	-------------

8.712-553.0	200-650 PSI
8.712-554.0	0-300 PSI

## NYLON PRESSURE REGULATOR

Maximum corrosion resistance.



- Male Inlet / Female Outlet
- Temperature: 120°F
- Weight: 4 oz.
- Up to 15.0 GPM
- Stainless-Steel Spring
- Positive Viton Seal to Prevent Leakage and Provide Best Chemical Resistance
- Knurled Locknut for Easy Adjustment
- Tee-Handle Adjustment Screw
- Choice of 1/2" or 3/4" Inlet / Outlet

PART NO.	INLET	OUTLET	ADJUSTABLE PRESSURE RANGE
8.712-555.0	1/2"	3/4"	0-250 PSI
8.712-552.0	3/4"	3/4"	0-250 PSI
8.712-556.0	3/4"	3/4"	0-400 PSI

## BULKHEAD FITTINGS



- Black Polypropylene
- Double-Threaded with EPDM Gasket
- Opening Same Size as Outside Diameter

PART NO.	FPT	HOLE DIA
8.705-336.0	1/2"	1-5/8"
8.705-338.0	3/4"	1-5/8"
8.705-144.0	3/4"	1-3/4"
8.705-145.0	1"	1-3/4"
8.705-339.0	1"	2-1/2"
8.705-341.0	1-1/4"	2-1/2"
8.705-342.0	1-1/2"	2-1/2"
8.705-146.0	1-1/2"	3"
8.705-147.0	2"	3"
8.705-343.0	2"	3-1/8"

### GASKET FOR ABOVE

8.705-337.0	Fits 1/2", 3/4"
8.705-340.0	Fits 1", 1-1/4", 1-1/2"
8.705-344.0	Fits 2"

## BULKHEAD / TANK FITTINGS - BRASS



- Use to drain or remove liquids from tanks, drums, etc.
- Heavy-Duty Brass
- Includes nut and aluminum grip water

PART NO.	OVERALL LENGTH	MOUNTING HOLE DIAMETER
8.705-139.0	1/8" x 1.5"	5/8"
8.705-140.0	1/4" x .94"	3/4"
8.705-141.0	1/4" x 1.5"	3/4"
9.802-149.0	3/8" x 1.3"	1"
9.802-150.0	1/2" x 1.5"	1-1/8"

Note: Installation requires access to inside of tank

## DIAPHRAGM CHECK VALVES - NYLON

For drip-free spraying.



- PSI: 125
- Operating Pressure PSI: 10
- GPM: 2.0
- Nylon Body, Polypropylene End Cap - EPDM - Diaphragm
- 1/4" MPT Inlet, 11/16" - 16 Male Outlet Nozzle Thread
- Spring-backed diaphragm for positive actions

PART NO.	DESCRIPTION
8.709-377.0	Diaphragm Check Valves

- DO NOT USE... Polypropylene for: gasoline, nitric acid, trichlorethylene, toluene, aromatic hydrocarbons or kerosene. Polypropylene "P" - black / glass reinforced
- DO NOT USE... Nylon for: hydrochloric acid, chlorine, fluorine, nitric, xylene or phosphoric or sulfuric acids. Nylon 6/6 "N" white / natural color.

**PLASTIC FITTINGS**

For cater and chemical supply lines. Ideal for use with most alkaline-based detergents, most agricultural chemicals, ethanol, and most ammonium and sodium-based compounds.

■ PSI: 150

■ Temperature Max: 140°F at 90 PSI

■ Temperature Max: 90°F at 150 PSI



8.705-265.0



8.705-289.0



8.705-317.0



8.705-335.0

PART NO.	DESCRIPTION	BARB X MPT
<b>HOSE BARBS - BARB X MPT</b>		
8.705-262.0	Poly	1/4" x 1/4"
8.705-264.0	Poly	1/4" x 3/8"
8.705-263.0	Poly	3/8" x 1/4"
8.705-265.0	Poly	3/8" x 3/8"
8.705-268.0	Poly	1/2" x 3/8"
8.705-270.0	Poly	5/8" x 1/2"
8.705-277.0	Nylon	1/4" x 1/4"
8.705-280.0	Nylon	1/4" x 3/8"
8.705-278.0	Nylon	3/8" x 1/4"
8.705-281.0	Nylon	3/8" x 3/8"
8.705-284.0	Nylon	3/8" x 1/2"
8.705-282.0	Nylon	1/2" x 3/8"
8.705-285.0	Nylon	1/2" x 1/2"
8.705-288.0	Nylon	1/2" x 3/4"
8.705-283.0	Nylon	5/8" x 3/8"
8.705-286.0	Nylon	5/8" x 1/2"
8.705-289.0	Nylon	5/8" x 3/4"
8.705-287.0	Nylon	3/4" x 1/2"
8.705-290.0	Nylon	3/4" x 3/4"
8.705-291.0	Nylon	1" x 3/4"

PART NO.	DESCRIPTION	BARB X MPT
<b>90° BARB X MPT ELBOWS</b>		
8.705-293.0	Poly	1/4" x 1/4"
8.705-296.0	Poly	1/4" x 3/8"
8.705-294.0	Poly	3/8" x 1/4"
8.705-298.0	Poly	3/8" x 3/8"
8.705-301.0	Poly	3/8" x 1/2"
8.705-295.0	Poly	1/2" x 1/4"
8.705-299.0	Poly	1/2" x 3/8"
8.705-303.0	Poly	1/2" x 1/2"
8.705-307.0	Poly	1/2" x 3/4"
8.705-304.0	Poly	5/8" x 1/2"
8.705-308.0	Poly	5/8" x 3/4"
8.705-305.0	Poly	3/4" x 1/2"
8.705-310.0	Poly	3/4" x 3/4"
8.705-300.0	Nylon	3/8" x 1/2"
8.705-306.0	Nylon	1/2" x 3/4"
8.705-309.0	Nylon	3/4" x 3/4"
<b>HEX NIPPLE - MPT X MPT</b>		
8.705-316.0	Poly	1/4" x 1/4"
8.705-317.0	Poly	3/8" x 3/8"
8.705-323.0	Poly	1/2" x 3/8"
8.705-319.0	Poly	1/2" x 1/2"
8.705-326.0	Poly	3/4" x 1/2"
8.705-321.0	Poly	3/4" x 3/4"
8.705-324.0	Nylon	1/2" x 1/4"
8.705-318.0	Nylon	1/2" x 1/2"
8.705-320.0	Nylon	3/4" x 3/4"
<b>ELBOWS - BARB X BARB</b>		
8.705-335.0	Poly	3/8" x 3/8"
<b>TEES BARB X BARB X BARB</b>		
8.705-327.0	Nylon	1/4" B x B x B
8.705-328.0	Nylon	3/8" B x B x B
<b>"PUSH-ON" HOSE BARBS - NORMALLY DOES NOT REQUIRE CLAMPS</b>		
8.705-346.0	Nylon	1/4" B x 1/4" FPT



**A**

2nd Story Nozzle Kit, 2 PK..... 193

21" Undercarriage Cleaner Kit..... 139

A+ 24" Venturi Pump Surface Cleaner ..... 136

AB 84 CUL..... 76

Accumulator by Interpump..... 234

Accumulator - Pulse Dampener ..... 234

Adapters - Brass ..... 176

Adapters - High PSI - Steel ..... 181

Admiral Pump Repair Kits ..... 216

AG Hose - Complete Assembly..... 167

AG Hose - Orange PVC-Ribbed - Bulk..... 166

Air-filter / Regulators ..... 305

Air Valve - Coil Blow Out ..... 260

Anti-seize Compound ..... 235

AP1000 Open Gun ..... 155

AP Dump Gun..... 155

AP Uninsulated Lances..... 158

AR Direct Drive Pumps ..... 228

AR Pump Kits..... 230

AR Pump Repair Kit Selection Chart..... 229

AR Triplex Ceramic Plunger Pumps..... 227

Axial Pumps Repair Kits..... 125

Axial Pumps, Repair Kits and Tools..... 123

Axial Pumps, Repair Kits and Tools (continued)..... 124

Axial Pumps, Repair Kits and Tools (continued)..... 125

**B**

B 40 W Accessories..... 63

B 40 W Bp..... 62

B 80 W Bp..... 64

B 110 R..... 65

B 110 R Accessories..... 66

B 150 R Bp..... 67

B 150 R BP Accessories..... 68

Baldor Motors - C-Face Open Drip Proof (ODP) ..... 265

Baldor Motors - Open Drip Proof (ODP)..... 266

Ball Valves - 454 Series, Polypropylene, Low PSI ..... 258

Ball Valves - 2940/3830 Mini Series, Low PSI..... 258

Ball Valves - BKH Series, High PSI ..... 257

Ball Valves - Forged-brass, Low PSI ..... 256

Ball Valves - Mini, Low PSI..... 256

Ball Valves - Model 727, 3 Way..... 258

Ball Valves - Nickel-plated Brass, Low PSI..... 257

Ball Valves - PVC, Low PSI..... 257

Ball Valves - RKH Series - Stainless-steel, High PSI ..... 257

Ball Valves - Shut-off, High PSI..... 257

Ball Valves - Stainless-steel, Low PSI ..... 256

Ball Valves - Stainless-steel, Low PSI, One Piece..... 257

Ball Valves - T-601 Series Compact PVC, Low PSI ..... 258

Barbs - Push-N-Lock..... 178

Battery Boxes with Cover, Marine Style ..... 303

BD 38/12 C Bp ..... 58

BD 50/50 C Classic Bp ..... 59

BD 70/75 W Bp Classic..... 60

BD 80/100 W Bp Classic ..... 61

BDS 51/175 C..... 77

Big Gun..... 154

Big Stainless-steel Lances & Side Handles ..... 158

Blower Wheels - Beckett..... 276

Blower Wheels - Wayne ..... 275

BR 35/12 C Bp..... 57

BRC 30/15 C ..... 48

Breaker Switches..... 300

Briggs & Stratton Engine Parts..... 264

Briggs & Stratton Engines - Gasoline..... 264

Brushes ..... 143

Brushes - Foam & Accessories ..... 305

Burner Chart - Beckett ..... 272

Burner Chart - Wayne ..... 274

Burner Controller and Contractor Tool - Genisys™..... 273

Burner Ignitor / Base Plates - Beckett..... 278

Burner Ignitors - Allanson ..... 278

Burner Ignitors - Beckett..... 277

Burner Ignitors - Wayne..... 278

Burner Motors ..... 276

Burner Parts - Beckett - Electrode / Insulator Assembly.... 273

Burner Parts - Beckett - Misc Repair..... 273

Burner Repair Parts / Common - Beckett & Wayne..... 275

Burner Repair Parts - Wayne ..... 275

Burners - Beckett 14V DC..... 272

Burners - Beckett - 115V / 230V..... 272

Burners - Wayne ..... 274

Burner Transformers - Allanson..... 277

Burner Transformers - Beckett ..... 277

Burner Tune Up Kit - Beckett ..... 276  
 Bushings - Brass ..... 176  
 BV/Vac Pac™ HEPA Series ..... 56

**C**

Cadet™ 7 ..... 49  
 Cam Switches - 2-Position ..... 299  
 Cam Switches - 3-Position - "Elektra" Universal ..... 298  
 Cam Switches - 3-position - Machine Control ..... 297  
 Cam Switches - 3-Position -SALZAR "BIG BOOT" ..... 297  
 Cam Switches - On / Off with Box - "Elektra" ..... 298  
 Cam Switches - Rotary - Salzer ..... 292  
 Cam Switches with & without Box ..... 297  
 Car Wash Booms, "Reflex" ..... 306  
 CAT Triplex Pumps ..... 231  
 Ceramic Plungers ..... 226  
 Ceramic Unitized Ball Valve ..... 152  
 Check Valves - 460 Series, High PSI ..... 255  
 Check Valves / Backflow Preventor - T533 Model,  
 Vacuum Breaker ..... 255  
 Check Valves - PVC, Low PSI ..... 255  
 Check Valves - Spring Loaded, High PSI ..... 255  
 Check Valves - Spring Loaded, Low PSI ..... 255  
 Check Valves - Stainless-steel, High PSI ..... 254  
 Check Valves - Swing Action, Low PSI ..... 254  
 Chemical Injectors - 400 Series ..... 251  
 Chemical Injectors - 505 Series Stainless-steel ..... 252  
 Chemical Injectors - Adjustable, with Quick-connect ..... 252  
 Chemical Injectors - Amerimax Series ..... 249  
 Chemical Injectors - Amerimax Series - Quick-  
 coupled Assemblies ..... 249  
 Chemical Injectors - Brass ..... 252  
 Chemical Injectors - Hi-Lo ..... 251  
 Chemical Injectors / Pressure Reducer - Extact-A-Flow ..... 252  
 Chemical Injectors - Robokim ..... 250  
 Chemical Injectors - Robokim Quick-Coupled Assemblies .. 250  
 Chemical Injectors - ST-60 Series ..... 249  
 Chemical Injectors - ST-62 Variable ..... 250  
 Chemical Injectors - ST-64, Up Stream ..... 250  
 Chemical Injectors - Stainless-steel ..... 249  
 Chemical Injectors - Stainless-steel ..... 252  
 Chemical Metering Valves - Brass ..... 259  
 Chemical Metering Valves - Dual - ST-66 Model ..... 259

Chemical Metering Valves - Flow Control ..... 259  
 Chemical Metering Valves - Flow Selector, 3 & 4 Way ..... 258  
 Chemical Metering Valves - Series 28, Flow Control ..... 259  
 Chemical Metering Valves - Series 28, Flow Control ..... 259  
 Chemical Metering Valves - ST-61 ..... 249  
 Circuit Breakers ..... 296  
 Cleaning Heads & Brushes ..... 69  
 Cleaning Heads & Brushes ..... 70  
 Cleaning Heads & Brushes ..... 71  
 Coils ..... 132  
 Coils ..... 133  
 Comet Pumps and Pump Kits ..... 232  
 Comet Pumps & Pump Kits - MC25-GR (with  
 Gear Reducer) ..... 232  
 Complete Wheels ..... 304  
 Connector Clamps - Romex (Metal) ..... 300  
 Connector Hose ..... 169  
 Connector Hose - 2' - 10' ..... 168  
 Connectors - DP - Cutler-Hammer ..... 291  
 Connector / Strain Reliefs - Liquid Tight - For Cable,  
 Wire & Tubing ..... 301  
 Cord Caps & Plugs ..... 300  
 Couplers - Lance & Nozzle Couplers ..... 203  
 Couplers Sections - Browning / Lovejoy ..... 269  
 Couplings and Adapters ..... 104  
 Couplings - Field Attachable ..... 167  
 Couplings - Galvanized ..... 183  
 Couplings - Hex - Heavy Wall Steel ..... 181  
 Couplings - Hex - High PSI - Steel ..... 181  
 Crimp Fittings ..... 167  
 Crosses - 4 Connects - High PSI - Steel ..... 182  
 Crosses - FPT - Brass Extruded ..... 178  
 Curb Cleaner ..... 139  
 CVS 65/1 Bp ..... 51

**D**

Digital Power Monitor ..... 299  
 Disinfectant - Vital Oxide ..... 146  
 Draft Diverters & Rain Caps ..... 281  
 Drain Cocks ..... 179  
 Drum Pumps - Red Head ..... 142  
 Drum Pumps - Tools / Accessories ..... 142  
 Drum / Tank Pump - Crank Style ..... 142

Dual Lances .....	156
Dual Lances .....	156
Duct Cleaner .....	140
Duct Cleaner .....	140
DUMP GUN- SJ3000 .....	155

## E

Easy!Force Trigger Gun and Easy!Lock Accessory System.....	93
Easy!Force Trigger Gun and Easy!Lock Accessory System.....	94
EB 30/1 .....	41
Economy Trigger Gun .....	152
Elbows - 45° .....	181
Elbows - 90° - Brass.....	177
Elbows - 90° - Galvanized .....	183
Elbows - High PSI - Steel.....	182
Elbows - Street - 90° - Galvanized .....	183
Elbows - Street-Brass .....	177
Elbows - Street - High PSI - Steel .....	182
Engine Parts - Kohler Lombardini .....	265
Engines - Kohler Lombardini - Diesel .....	264

## F

Fiberglass Telescoping Wands.....	159
Filters - Blue Top .....	187
Filters - Chemical - Brass.....	183
Filters - Chemical - Brass / Plastic .....	184
Filters - Chemical Lines with Filter .....	184
Filters - Chemical - "The Big One" .....	183
Filters - Clear Bowl.....	184
Filters - Fuel .....	186
Filters - Fuel - Clear Bowl.....	187
Filters - Fuel Element - General .....	187
Filters - Fuel / Water Separator - Legacy .....	187
Filters - Fuel / Water Separator - Racor .....	188
Filters - Funnel - Racor .....	188
Filters - High-volume.....	187
Filters - In-line - All Metal .....	184
Filters - In-line - Can-type.....	185
Filters - In-line - Clearview .....	185
Filters - In-line - Green-cap.....	184

Filters - In-line - Heavy-duty .....	184
Filters - In-line - Nozzle - High-pressure.....	186
Flanges - Interpump / General Pump .....	236
Flanges - Legacy.....	236
Flat-free Tires .....	303
Flex Couplers - Interpump / General Pump .....	236
Flex Couplers - Legacy .....	236
Flex Couplings - Beckett.....	273
Flex Lances .....	159
Flex Line Bypass / Supply Line Hose .....	169
Float Valves - Adjustable, Bronze.....	252
Float Valves - Balls, Copper & Plastic.....	253
Float Valves - Brass.....	254
Float Valves - Brass Float with Ball & Stem .....	253
Float Valves - Diaphragm.....	253
Float Valves - Hudson .....	254
Float Valves - Kerick.....	254
Float Valves - PA Brass Assembly .....	253
Float Valves - ST-8, Brass Assembly.....	253
Float Valves - Stems .....	253
Float Valves - Vertical .....	254
Flow Meters - Visi - Float .....	261
Flow Switches - GP - TMT .....	288
Flow Switches - Legacy .....	288
Flow Switches - Legacy MV60 & AP500.....	288
Flow Switches - Phoenix with Pilot .....	288
Flow Switches - ST-5 & ST-6.....	288
Flow Switches - ST-7 with Micro Switch .....	288
Flow Switches - ST-505 Stainless-steel .....	289
Flow-Thru Gun.....	155
Foam Cannon - Adjustable Pattern 2L .....	144
Foam Cannon - Wide Mouth 1.5L.....	144
Foamers - Adjustable with Tank.....	145
Foamers - Foam Cannon.....	143
Foamers - Foam Cannon.....	206
Foamers - Foam Jet Kit .....	145
Foamers - Lafferty Airless 10/20 SS.....	145
Foamers - Legacy Compact .....	144
Foamers - Legacy Compact .....	206
Foamers - PF22 MTM Hydro Foam Cannon.....	144
Foamers - Suttner ST-75/76 Kits .....	144
Foam Systems and Cleaning Agent Injectors.....	119
Foam Systems and Cleaning Agent Injectors (continued)....	120
Foot / Check Valve.....	186

## INDEX

Foot-Controlled Pressure Valve.....	142
Foot Valves - Suction - ST35 / ST35R.....	186
Frames, Direct Drive.....	302
Fuel Caps.....	303
Fuel Conditioner and Soot Remover.....	276
Fuel Nozzles - Check Valve - "Snap".....	286
Fuel Nozzles - Delavan - 45° & 60°.....	282
Fuel Nozzles - Delavan - 70°.....	283
Fuel Nozzles - Delavan - 80°.....	284
Fuel Nozzles - Delavan - 90°.....	285
Fuel Pump - Beckett Cleancut.....	276
Fuel Pumps & Replacement Parts - Suntec.....	277
Fuel Solenoid Valve - 12V DC Kip.....	278
Fuel Solenoid Valves / Coils - Suntec.....	279
Fuel Tank, 9-gallon Diesel.....	302
Fuel Tanks.....	302
Fuses.....	296
Fuses.....	306

## G

Galvanized Pipe Fittings.....	183
Garden Hose - Apex Quality.....	166
Garden Hose - Cold Weather.....	166
Garden Hose Fittings.....	180
Gas Conversion Kits - LP - Robert Shaw.....	281
Gas Jets.....	279
Gas Pilots.....	281
Gas Regulators - LP.....	280
Gas Regulators - LP Gas Conversion Kits.....	280
Gas Regulators - Natural Gas.....	280
Gas Valve Accessory Components.....	286
Gas Valves - 1" by Robert Shaw.....	281
Gas Valves - Honeywell.....	279
Gas Valves - LP or Natural.....	286
Gear Box Lube.....	235
Geared Reduction Units - Interpump / General Pump.....	236
Gear Reduction.....	235
Generator - Voltmaster.....	299
Generator - WINCO- AC- TB2400.....	299
GFCI Module.....	300
GFCI - with and without Plugs & Cords.....	301
Giant Trigger Guns.....	152
Gloves - Industrial Duty.....	146
GP Locking Trigger Gun.....	155
GP Pump Packing / Extraction Kit - Complete.....	235
Gun, Dual Lance Combo.....	160
Gutter Cleaner Attachment.....	159

## H

Hand Cleaner - Victor Waterless Command-O with Pumice.....	147
Handles - Fiberglass "Super Handles".....	143
HD 7.9/72-4 Cage Ec.....	36
HD Cabinet - Belt Drive.....	28
HD Cart.....	33
HD Compact Class.....	20
HD Mid Class.....	22
HD Mid Class Cage.....	21
HD PB Cart.....	34
HD PB / PeB / D Cage.....	35
HD Roll Cage.....	27
HDS Cabinet.....	7
HDS Compact Class.....	3
HD Series Electric.....	26
HD Series Gas.....	31
HD Series Gas Skid.....	32
HD Special Class.....	24
HDS P / PE Cage.....	12
HDS Special Class.....	6
HDS Super Class.....	5
HD Super Class.....	23
HDS Upright Class.....	2
HDS VHP.....	11
HD Wall Mounted.....	25
Hex Couplings - Brass.....	176
Hex Couplings - Reducing - Brass.....	176
Hex Nipples - Double - Brass.....	176
Hex Pipe Plugs - High PSI - Steel.....	182
Hex Reducing Nipples - Brass.....	176
High-pressure Hoses.....	97
High-pressure Hoses.....	98
Hobby Gun, Lance and Hose.....	160
Hobby Hose.....	166
Honda Engine Parts.....	264
Hose - 1-Wire.....	161

Hose - 2-Wire ..... 161

Hose - A+ 1- & 2-Wire with Coupling and Plug, Non-marking..... 164

Hose - A+ 1-Wire Gray Smooth Cover, Non-Marking..... 163

Hose - A+ / Tuff-flex - 1-Wire Smooth Cover..... 164

Hose - A+ / Tuff-flex - 2-Wire Smooth Cover..... 164

Hose Barbs - Brass ..... 179

Hose Barbs - Brass Check Barbs ..... 179

Hose Barbs - Orificed ..... 179

Hose Barbs - Swivel - Low Pressure..... 179

Hose Bend Restrictors..... 165

Hose Clamps..... 181

Hose - Gray Non-Marking 1 & 2-Wire - with & without Couplers..... 162

Hose - Legacy 1- & 2-Wire, Non-marking ..... 163

Hose - Legacy 1- & 2-Wire with Couplers or M22 Ends..... 162

Hose - Legacy 1-Wire Smooth Cover, Non-marking..... 163

Hose - Legacy High-pressure ..... 161

Hose Reels and Brackets ..... 101

Hose Reels - AP..... 149

Hose Reels - Coxreels..... 150

Hose Reels - General Pump A-frame Hose Reels..... 151

Hose Reels - General Pump Swivels ..... 151

Hose Reels - Legacy Pivot & Fixed Base..... 148

Hose Reels - Legacy Stackable..... 147

Hose Reels - Legacy Swivels..... 148

Hose Reel Swivels..... 102

Hoses - Connector / Car Wash Bay, 12'-25' ..... 308

Hose - Whitewater® Combination Steam Hose..... 165

Hour Meters for Gasoline Engines..... 263

**I**

Indicator Lights ..... 300

Insulation and Rigid Disc / Donuts ..... 287

Interpump / General Pump - Car Wash Solid-shaft Pump... 222

Interpump / General Pump - EZ Series Hollow-shaft..... 223

Interpump / General Pump - Hollow-shaft..... 223

Interpump / General Pump Kit Selection Chart ..... 224

Interpump / General Pump Kits - Genuine ..... 225

Interpump / General Pump Kits - Genuine (continued) ..... 226

Interpump / General Pump - Large Frame Solid-shaft Pump ..... 222

Interpump / General Pump - Series "44" (EZ Series) Solid-shaft Pump ..... 222

Interpump / General Pump - Solid-shaft Pumps..... 221

Interpump / General Pump - TSF Solid-shaft Pump ..... 222

Interpump / General Pump - TX Series Hollow-shaft..... 223

Interpump / General Pump - TX Solid-shaft Pump ..... 222

Interpump / General Pump - V-packing Insertion Tool Kit 234

Interpump Packing / Extraction Tool..... 234

iSolar 400/800 Solar Panel Cleaner ..... 95

iSolar 400/800 Solar Panel Cleaner ..... 96

**J**

Jalapao Series ..... 13

Jarvis Series..... 29

Jetter Pulse Valves..... 233

JRod Multi-Nozzle Holder ..... 205

JRod Multi-Nozzle Holder ..... 205

Junction Boxes..... 295

**K**

Kärcher Detergents..... 78

Kärcher R1 and R2 Hose ..... 99

Kärcher Tools ..... 130

Kärcher Tools..... 131

Kärcher Triplex Pump Repair Kits ..... 129

Kärcher Triplex Pumps..... 126

Kärcher Triplex Pumps..... 127

Keyed Ignition Switch - 12V DC..... 265

KM 70/20 C ..... 42

KM 70/30 C Bp Adv ..... 43

KM 75/40 W Bp..... 44

KM 85/50 R Bp ..... 45

KM 90/60 R Bp Adv ..... 46

**L**

Lance Handles / Accessories..... 159

Lances - Flex ..... 307

Legacy "Best" Spray Gun ..... 152

Legacy HD Pump ..... 207

Legacy HD Pump - FOG NEMA Series ..... 210

Legacy HD Pump - GF & GFP Series ..... 210

Legacy HD Pump - GM Series ..... 208

Legacy HD Pump - GP & GPP Series ..... 210

Legacy HD Pump - GS Series ..... 210

Legacy HD Pump - GT Series ..... 208

Legacy HD Pump - GX Series ..... 207

Legacy HD Pump - HY Series ..... 211

Legacy HD Pump - Ready to Go Series ..... 208

Legacy HD Pump Repair - Ceramic Plunger Kits ..... 220

Legacy HD Pump Repair - Complete Kits ..... 220

Legacy HD Pump Repair Kit Selection Chart ..... 217

Legacy HD Pump Repair Kit Selection Chart (continued) ... 218

Legacy HD Pump Repair Kit Selection Chart (continued) ... 219

Legacy HD Pump Repair - Plunger Oil Seal Kits ..... 221

Legacy HD Pump Repair - Seal Kits ..... 219

Legacy HD Pump Repair - Valve Kits ..... 220

Legacy Industrial Gun and Lance Combo ..... 160

Legacy "Industrial" Spray Gun ..... 152

Legacy Oval Molded Grip Lances ..... 157

Legacy Pump ..... 213

Legacy Pump - GBP & GB Series ..... 208

Legacy Pump - HFR Series ..... 209

Legacy Pump - HHP Series ..... 209

Legacy Pump - KKV Series ..... 211

Legacy Pump - NLT Series ..... 209

Legacy Pump - NMT Series ..... 209

Legacy Pump Repair Kits ..... 215

Legacy Pump Repair Kit Selection Chart ..... 214

Legacy Pump Repair Tool Kit ..... 214

Legacy Pump - TMH Series ..... 213

Legacy Pump - TML Series ..... 211

Legacy Pump - TTV Series ..... 211

Legacy Pump - WJG Series ..... 212

Legacy Pump - WJH-F & WJH Series ..... 212

Legacy Pump - WMG 1 Series ..... 213

Legacy Pump - WMG Series ..... 212

Legacy Square Molded Grip Lances ..... 157

Legacy Vented Lances ..... 158

Locknut Fittings - Hex-Head Plugs ..... 180

Locks for Meter Boxes ..... 306

**M**

---

M407 Trigger Gun ..... 152

Miscellaneous Hoses ..... 100

Miscellaneous Parts ..... 304

Mississippi Recovery ..... 39

ML320 ..... 155

Mobile Hot Water Generator ..... 37

mojave series ..... 4

Molded Plastic Float Tanks ..... 302

Motor Contactors - Coils & Thermal Overloads ..... 293

Motors - A.O. Smith - Pressure Washer - Open Drip Proof (ODP) ..... 267

Motor Starter with Sealed Box - Manual ..... 294

Motors - Totally Enclosed Fan Cooled (TEFC) ..... 267

Motors - WEG - Pressure Washer ..... 268

MV925 Gun and Lance Combo ..... 160

MV925 Gun, Lance and Hose Combo ..... 160

MV 925 Open Gun ..... 155

MV925 Trigger Gun ..... 152

MV Lance Handle ..... 159

**N**

---

Nipples - Brass - Open & Close ..... 177

Nipples - Hex - High PSI - Steel ..... 181

Nipples - JIC - Brass ..... 178

Nipples - JIC X-Pipe ..... 177

Nipples - Pipe - MPT - High PSI - Zinc ..... 183

Nozzle Fan Selection ..... 190

Nozzle Filters - 1/4" High-pressure ..... 203

Nozzle Holder - Double ..... 204

Nozzle Holder Grommet ..... 193

Nozzle Holder / Head - ST-56 Rollover ..... 204

Nozzle Holder - Pivot ..... 204

Nozzle Holder - Rollover - Twist Type ..... 206

Nozzle Holder - ST-51N Adjustable ..... 204

Nozzle Holder - ST-330 - Swiveling ..... 204

Nozzle Protector / Coupler ..... 206

Nozzle Protector - Slip-on ..... 206

Nozzle Protector - ST-10 ..... 199

Nozzles - 1/4" Veejet - Broad Spray Stainless-steel ..... 196

Nozzles - 1/4" Veejet - Low-pressure - Brass ..... 197

Nozzles - 3650 & 5100 PSI Turbo.....	201
Nozzles - A+ / AP Revolution Turbo .....	199
Nozzles - A+ Multi-fan.....	203
Nozzles - Adjustable.....	205
Nozzles and Power Nozzles.....	109
Nozzles - Duo-reg.....	203
Nozzle Sets - GP - QC 4 & 5 Packs - Color-coded.....	192
Nozzle Sets - Legacy - QC 4 & 5 Packs - Color-coded .....	191
Nozzles - Gum RemovAl.....	205
Nozzles - HL250 Vari Hi-low Angle.....	204
Nozzle Size Selection Chart.....	190
Nozzles - Legacy - QC - 1/4" Color-coded.....	191
Nozzles - Legacy Revolution Turbo .....	198
Nozzles - Long distance.....	206
Nozzles - MEG - 1/4" Male Threads.....	194
Nozzles - MEG - 1/4" - M-Style .....	193
Nozzles - MEG - 1/8" - "Washjet".....	195
Nozzles - MV Rotojet 3700 & 5800 Turbo.....	200
Nozzles - MV Triple-function.....	202
Nozzles - QC - 1/4" - Q-Style.....	192
Nozzles - QC "Wash Jet".....	196
Nozzles - Rotojet 2500.....	203
Nozzles - Soap.....	198
Nozzles - Soap Nozzles.....	193
Nozzles - ST-357 & ST-457 Turbo.....	201
Nozzles - Steam.....	205
Nozzles - Steam.....	205
Nozzles - Turbo - A+ Nozzle Kit.....	199
Nozzles - Turbo - IDK & DK Series - Dirt Killer .....	202
Nozzles - Turbo MV Rotating Soft / Hard.....	202
Nozzles - Viper Rotating .....	202
Nozzle System - Tip Jet.....	197
Nozzle System - Tip Jet Adapter Caps.....	198
Nozzle System - Tip Jet Nozzle Bodies .....	197
Nozzle System - Tip Jet Retainer.....	198
Nozzle System - Tip Jet Retainer Caps.....	198
Nozzle System - Tip Jet Strainers.....	198
Nozzles - ZRMax & ZRotomax Rotating .....	202
NT 30/1 Accessories.....	53
NT 30/1 Tact TE.....	52
NT 48/1 .....	54
NT 68/1 .....	55

## O

---

O-Ring Replacements.....	174
O-Rings.....	171
Other Accessories.....	121
Other Accessories.....	122
Overload Relays for Contractors.....	292

## P

---

PA Linear Gun.....	154
PA Trigger Gun .....	154
Pipe Cleaning.....	116
Piston Pumps - Hypro.....	233
Plastic Dip Tube Assembly .....	303
Plugs - Allen Head.....	180
Plugs - Hex Head.....	180
Power Cord - Molded.....	292
Powered Damper.....	281
Pressure Gauge - Fuel / Oil.....	261
Pressure Gauges - 100 Series Pneumatic.....	261
Pressure Gauges - ABS, Corrosion-resistant .....	262
Pressure Gauges - Port Kit .....	261
Pressure Gauges - Stainless-steel .....	262
Pressure Gauges / Temperature Test Set .....	263
Pressure Gauges - Vacuum - Stainless-steel .....	262
Pressure Loop - 2-Wire.....	165
Pressure Regulator, Water 2-Way.....	262
Pressure Relief Valve - Easy-start, High PSI.....	261
Pressure Relief Valve - Easy-start, Low PSI.....	261
Pressure Relief Valves.....	260
Pressure Relief Valves - SR/S3.....	247
Pressure Relief Valves - Timax .....	247
Pressure Relief Valves - VS 200 / 180, High PSI.....	248
Pressure Relief Valves - vs 220 .....	248
Pressure Relief Valves - vs 350, High PSI.....	248
Pressure Relief Valves - VS 500, High PSI .....	248
Pressure Switches - Compact & PS-6 SS.....	289
Pressure Switches - Legacy.....	289
Pressure Switches - PA - PR1 - Red.....	289
Pressure Switches - PR16 - Black.....	289
Pro HD 400 ED.....	19
Propane Gas Hose.....	280

## INDEX

Proportioner Float Valve Systems - Aqua Master™ Model 440 .....	311
Proportioners & Accessories - DEMA .....	311
PS 4/7 Bp OBC Mister & Electrostatic Sprayer .....	72
PTO Geared Multiplier .....	236
Pulley Bushings.....	269
Pulleys.....	270
Pulley-Sheaves.....	271
Pulse Hose .....	166
Pump - Air-operated - Flojet .....	305
Pump Lube.....	235
Pump Oil .....	235
Pump Packing Extractor Hammer & Sockets.....	234
Pump Packing & Seal Kits - Generic - A+ .....	233
Pump Parts and Tools.....	233
Pump Rails - Legacy & Legacy HD.....	213
Pumps - Air-driven - Flojet .....	305
Pump Technical Information.....	237
Pumptech Pump.....	236
Pump Tools - Extractor Pliers & Dental Pick .....	234
Puzzi™ 8/1 C.....	47

## Q

Q.C. Sockets & Plugs - A+ Brass .....	174
Q.C. Sockets & Plugs - Double Shut-off.....	174
Q.C. Sockets & Plugs - Extended Twist Seal .....	173
Q.C. Sockets & Plugs - Foster .....	171
Q.C. Sockets & Plugs - Legacy - Brass & Steel .....	171
Q.C. Sockets & Plugs - Legacy - Stainless-steel.....	171
Q.C. Sockets & Plugs- M22 - Quick Disconnect .....	173
Q.C. Sockets & Plugs - M22 - Twist Seal .....	173
Q.C. Sockets & Plugs - M22 - Twist Seal .....	173
Q.C. Sockets & Plugs - Snaptite Series.....	172
Q.C. Sockets & Plugs - ST Series.....	172
Quick Change Pumps .....	127

## R

Rain Suit, 2 Piece.....	146
Ranger.....	50
Reducing Bushing - High PSI - Steel .....	182

Reference / Calculation Guide.....	267
Regulating Relief Valve.....	248
Regulator Valve - Steam.....	260
Relays .....	292
Relay Switch.....	292
Replacement Fuel Cap.....	302
Replacement Orifices .....	204
Rocker Switches.....	298
Rotary Nozzles.....	113
Rotary Nozzles.....	114
Rubber Parts .....	303
Rupture Disks.....	260

## S

Sandblasters - Industrial .....	141
Sandblast Head - Professional .....	141
Sandblast Hose.....	141
Sandblast Kit - Tungsten Carbide Nozzle Head - Industrial...140	
Sandblast Nozzle Tips .....	141
Sand Nozzle.....	141
Scalemaster .....	147
Sechura - LP .....	10
Sechura - NG .....	9
Sechura Series.....	8
Sewer Hose.....	170
Sewer / Tube Cleaning Nozzles.....	189
Sewer / Tube Cleaning Nozzles - ST-49 & "Mini" .....	189
SG 4/4.....	73
SG Bp Gum Remover .....	75
SGV 6/5 .....	74
Sludge Sucker - ST-36 Pit Boss .....	142
Small Engine Test Equipment .....	269
Solenoid Valves - CFA - SS & Brass .....	309
Solenoid Valves - CFA - SS & Brass .....	309
Solenoid Valves - Kip - SS & Brass.....	310
Solenoid Valves with Built-in Strainers.....	310
Soot Pump.....	276
Sprayers - B&G Poly-molded .....	145
Sprayers - Chapin Air-Powered.....	145
Spray-Flex™ Flex Wand.....	159
Spray Lances.....	107
Spray Lances.....	108



ST-810 Suttner Trigger Gun..... 153

ST-1500h Open Gun ..... 155

ST-1500 Suttner Trigger Gun..... 153

ST-2000 Suttner Trigger Gun..... 153

ST-2305 Suttner Trigger Gun..... 153

ST-2305 Suttner Trigger Gun..... 153

ST-2315 Suttner Trigger Gun..... 153

ST-2605 Suttner Trigger Gun..... 153

ST-2700 Suttner Trigger Gun..... 153

ST-2720 Suttner Trigger Gun..... 152

Stainless-steel Float Tank ..... 302

Starter Solenoid - 12V DC..... 265

Stationary Hot Water Generator Series..... 38

Steam Jet Nozzles..... 115

Steam Lance ..... 142

Strainers / Tank Screen..... 186

Strainers - Y Trap..... 185

Surface Cleaner Nozzle Recommendation..... 138

Surface Cleaners..... 117

Surface Cleaners - A+ - 21" & 24"..... 136

Surface Cleaners - Economy - 8" & 15"..... 137

Surface Cleaners - GP - Flat 12", 18" & 20"..... 137

Surface Cleaners - Vac Recovery ..... 136

Surface Cleaners - Whisper Wash Flat..... 138

Surface Cleaners with Suction..... 118

Suttner Dual Lances ..... 157

Suttner Lances..... 158

Suttner Push and Pull Lance ..... 158

Suttner Trigger Gun..... 154

Switch Box - Raintite..... 295

Switches / Contact Blocks - Push Button - Cutler-Hammer ...291

Switches - Thermal - Hi-limit - Snap..... 290

Switches - Thermal - Hi-limit - Snap with Leads..... 290

Switches - Toggle - Motor Control..... 290

Switches - Toggle - Push Button..... 290

Switch - Rotary - 8-position ..... 306

Swivels - 90°..... 174

Swivels - A+ Long Body Style ..... 176

Swivels - Ball Bearing ..... 175

Swivels - Gun - Mosmatic ..... 175

Swivels - JIC..... 177

Swivels - Low-pressure - Car Wash ..... 307

Swivels - Medium-pressure - Car Wash ..... 307

Swivels - Right Angle..... 174

Swivels - Stainless-steel ..... 175

Swivels - Stainless-steel Ball Bearing..... 175

Swivels - Stainless-steel, High-pressure ..... 175

Swivels - Stainless-steel, High-pressure and Economy Brass..... 175

**T**

Tape - Teflon® Thread Sealing..... 146

Tape - Vinyl Electrical ..... 300

Tees - 3 Connects - High PSI - Forged ..... 182

Tees - Banded - 3 Connects - Galvanized..... 183

Tees - Branch-Brass..... 178

Tees - FPT - Forged-Brass..... 178

Tees - Street-Brass..... 178

Tees - Street Tee - High PSI - Steel..... 182

Temperature Gauge ..... 263

Temperature Gauge - Thermwell..... 263

Teton Series..... 30

Thermal Relief Valve / Pump Protector - Compact..... 259

Thermal Relief Valve / Pump Protector..... 260

Thermal Relief Valve / Pump Protector - TRV ..... 260

Thermostat - Adjustable - Flow-thru..... 299

Thermostat - Probe Style..... 299

Thread Lock Products..... 146

Throttle Control - Speedmaster ..... 263

Timer..... 296

Transformers..... 306

Transformers - Step-down..... 294

Trigger Gun - RB65 Wash Gun ..... 307

Trigger Guns..... 105

Triple Nozzles..... 111

Triple Nozzles..... 112

Triplex Pump Repair Kit Selection Chart..... 128

TRK-3500 ..... 16

TRK-6000 ..... 17

Tubing - Clear PVC..... 168

Tubing - Clear Reinforced PVC..... 167

Tubing - Heavy-duty Vinyl..... 168

Tule Series HDS 3.5/40 Ge MT..... 15

**U**

---

Underbody Wand Assembly - Self Serve..... 140

Undercarriage Cleaner ..... 138

Undercarriage Cleaner ..... 140

Undercarriage Cleaner & Roof Surface Cleaner ..... 139

Unloader Valves - 22900A Pressure Actuated Series ..... 246

Unloader Valves - APM Pressure Actuated Series..... 246

Unloader Valves - APR Series ..... 240

Unloader Valves - AR Bolt-on..... 246

Unloader Valves - Control Set "W" Series..... 243

Unloader Valves - Flow-actuated..... 247

Unloader Valves - Gymatic - 3/B & VR35 3/B Series..... 246

Unloader Valves - HM Model..... 244

Unloader Valves - Hypro-style ..... 244

Unloader Valves - Kits for K / ZK Series..... 243

Unloader Valves - K / ZK Series ..... 244

Unloader Valves - MG4000 Series ..... 247

Unloader Valves - Mounting Block..... 248

Unloader Valves - Pulsar RV Series ..... 241

Unloader Valves - ST-230..... 245

Unloader Valves - ST-261 Series..... 245

Unloader Valves - ST-280..... 245

Unloader Valves - UU1 Universal..... 239

Unloader Valves - VB3..... 240

Unloader Valves - VB7 Series ..... 241

Unloader Valves - VB8 Series ..... 241

Unloader Valves - VB9 / VB10 Trapped Pressure Series .... 243

Unloader Valves - VB75 / VB135 Series..... 242

Unloader Valves - VB80 / 400 Stainless-steel ..... 242

Unloader Valves - VB85 / 280 Series ..... 242

Unloader Valves - VB130/135 Series..... 242

Unloader Valves - VB200 High-volume Series..... 242

Unloader Valves - VB350 / VB7 Series..... 243

Unloader Valves - VBT Series..... 239

Unloader Valves - VR53 ..... 240

Unloader Valves - VR54/56 ..... 240

Unloader Valves - VR56/VBA35 Series ..... 240

Unloader Valves - VRT3 Series..... 241

Unloader Valves - VRT100 High-Volume Series..... 241

Unloader Valves - YU High Volume ..... 244

**V**

---

Vac Switches - Burner Control ..... 289

Vacuum Accessories..... 307

Vacuum Motors - A+ / AP..... 308

Vacuum Motors - Ametek-Lamb..... 308

Valve - 3-Way - Erie Motortrol®..... 311

V-belts - Super "Gripnotch"..... 270

Voltage Regulator - Heavy-duty 15V ..... 265

Voltmeters..... 263

VP Dual Lance..... 156

**W**

---

Wash Bay Accessories - Stainless-steel..... 306

Wash Brushes ..... 103

Water Broom 16"..... 139

Wayne Burner Replacement Parts & Cross Reference Chart ..... 135

Wayne Burners for Kärcher Pressure Washers..... 134

Wet Blasting Attachments..... 119

Wire Looms - Used for Wiring Harnesses ..... 300

**XYZ**

---

X-Jet Long Range Nozzle ..... 205

Yamada Pumps..... 238

Yamada Pumps Diaphragm Kits ..... 238

# IDENTIFYING KÄRCHER EQUIPMENT BY NAME

All Kärcher branded machines are named systematically so that every machine name explains what the product is. For example, all hot water pressure washer names start with HDS, while all cold water pressure washers names start with HD. Floor care product names range from a direct to indirect relation to the product, such as BV for Backpack Vacuum to KM for a Sweeper. Below is a chart to help with identifying Kärcher equipment by name.



## PRESSURE WASHER MACHINE NAMES

Model	GPM / PSI	Type	Voltage and Phase	Feature
HDS = Hot Water	Gallons Per Minute / Pounds Per Square Inch	U = Upright	Ea = 230V / 1 ph	e = electric start
HD = Cold Water		C = Compact	Eb = 230V / 3 ph	+ = Remote On / Off
		S = Super Class	Ec = 460V / 3 ph	
		ST = Stationary	Ed = 120V / 1 ph	
		G = Gas	Eg = 208 / 1 ph	
		P = Petrol	Eh = 208V / 3 ph	
		D = Diesel	Ef = 575 / 3 ph	
		E = Electric		
		B = Belt Driven		
		Mt = Mini Trailer		

**EXAMPLE: HDS 1.7/12 U ED = HOT WATER, 1.7 GPM / 1200 PSI, UPRIGHT, ELECTRIC, 120V / 1 PH**

## FLOOR CARE MACHINE NAMES

Model	CAPACITY LITERS / GALLONS	CLEANING PATH CM / Inches	OPTIONS / FEATURES
KM = Sweeper	4 = 1	1 = .4	BP = Battery Powered
Puzzi = Spotter or Box & Wand Extractor	25 = 6.6	4 = 1.6	C = Scrubbers = Pad Assist
NT = Wet/Dry Vacuum	30 = 7.9	12 = 5	C = Extractors = Compact
BR = Scrubber with Cylindrical Brushes	35 = 9.25	20 = 8	AP = Semi-Automatic Filter Cleaning System
BD = Scrubber with Disc Brushes	38 = 10.0	30 = 12	W = Scrubbers = Traction Drive
B = Scrubber	40 = 10.6	40 = 16	HEPA = HEPA Level Air Filtration
SG = Steamer	48 = 12.68	50 = 20	Tact = Triggered Aircraft Cleaning Technology
SGV = Steamer Vacuum	50 = 13.21	175 = 69	Te = Automatic Power Outlet
SG1 = Gum Remover	51 = 13.47		R = Ride-On Machine
AB = Air Blower	60 = 15.85		
BV = Backpack Vacuum	68 = 17.96		
CV = Upright Vacuum	70 = 18.49		
EB = Compact Sweeper	75 = 19.81		
BDS = Floor Machine	80 = 21.13		
	150 = 39.63		

**EXAMPLE: KM 70/20 C = SWEEPER, 18.49 GALLONS / 8 INCHES CLEANING PATH / COMPACT**

Please contact us for more information:

**Kärcher U.S.A.**

6398 N. Kärcher Way  
Aurora, CO 80019  
U.S.A.

Tel. 888-805-9852  
Fax 800-248-8409

 [www.karcher.com/us/professional](http://www.karcher.com/us/professional)

 KarcherUSA

 @kaercher\_us\_professional

 karchercommercial

 karcher-us

 KarcherUSA