

Adams Profile



### Finish:

Our advanced Powercoat™ finish allows us to produce a high quality, long-lasting finish, which is also environmentally friendly. The Powercoat™ finish is twice the thickness and hardness of a typical baked enamel finish. Meets AAMA 2604-5 standards for the ultimate in durability and UV protection.

### Materials:

All Ultra Signature™ Collection railing components are extruded from Ultrum™ 6005-TS alloy, with a minimum ultimate strength of 35,000 psi. Every railing system is assembled with hidden stainless steel, corrosion-resistant fasteners. Ultra Signature™ Collection posts come in a variety of thicknesses. Designer Accessories are zinc die cast aluminum. All Designer Accessories are Powercoat™ finished.

### Ultra Aluminum Lifetime Warranty

Ultra Aluminum™ fence and railing products are guaranteed for life against defects in workmanship and/or materials. The Powercoat™ finish on all fencing and railing by Ultra Aluminum™ is guaranteed for life against cracking, peeling or chipping. Visit our website for more information and a copy of the warranty.

### Environmentally Responsible

Ultra Aluminum™ is proud to use recycled aluminum in our products. Aluminum is the most commonly recycled metal in the world. Our Powercoat™ coating process is environmentally friendly and virtually pollution-free.

## Design Options

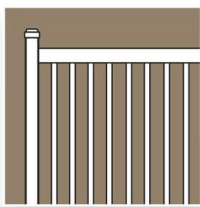

UAR-200-2R Two Rail

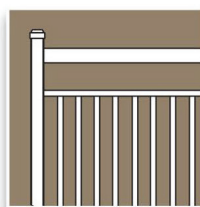

UAR-270-3R Three Rail

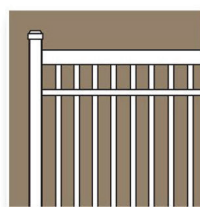

UAR-200-3R Three Rail

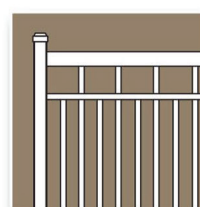

UAR-220-3R Three Rail



UAR-250-3RS Three Rail with Spears

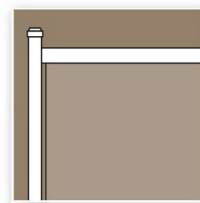

UAG-200-2R Glass Railing

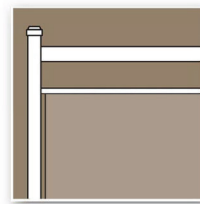

UAG-270-3R Glass Railing

## Railing Specifications

Components	Post-To-Post
<b>Square Picket</b>	¾" Sq. x 0.050" Thickness
<b>Top Cap Adams</b>	1.646"H x 1.716"W 0.080" Thickness
<b>Bottom Rail</b>	1.320"H x 1.352"W 0.070" Thickness
<b>Boss Screw Posts</b>	2½" x 2½" x 0.100" 3" x 3" x 0.125"
<b>Spacing Between Pickets</b>	3⅝"
<b>Post Spacing</b>	4' -- 48.25" 6' -- 70.50" 8' -- 97.25"
<b>Heights Available</b>	37" and 43"
<b>Signature Columns</b>	6" x 6" Square 0.100" Thickness 8" x 8" Square 0.100" Thickness

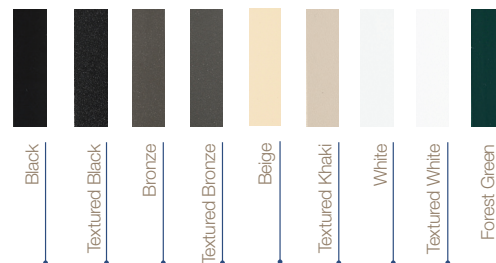

Colors shown represent an approximate comparison and may vary slightly from actual product color.

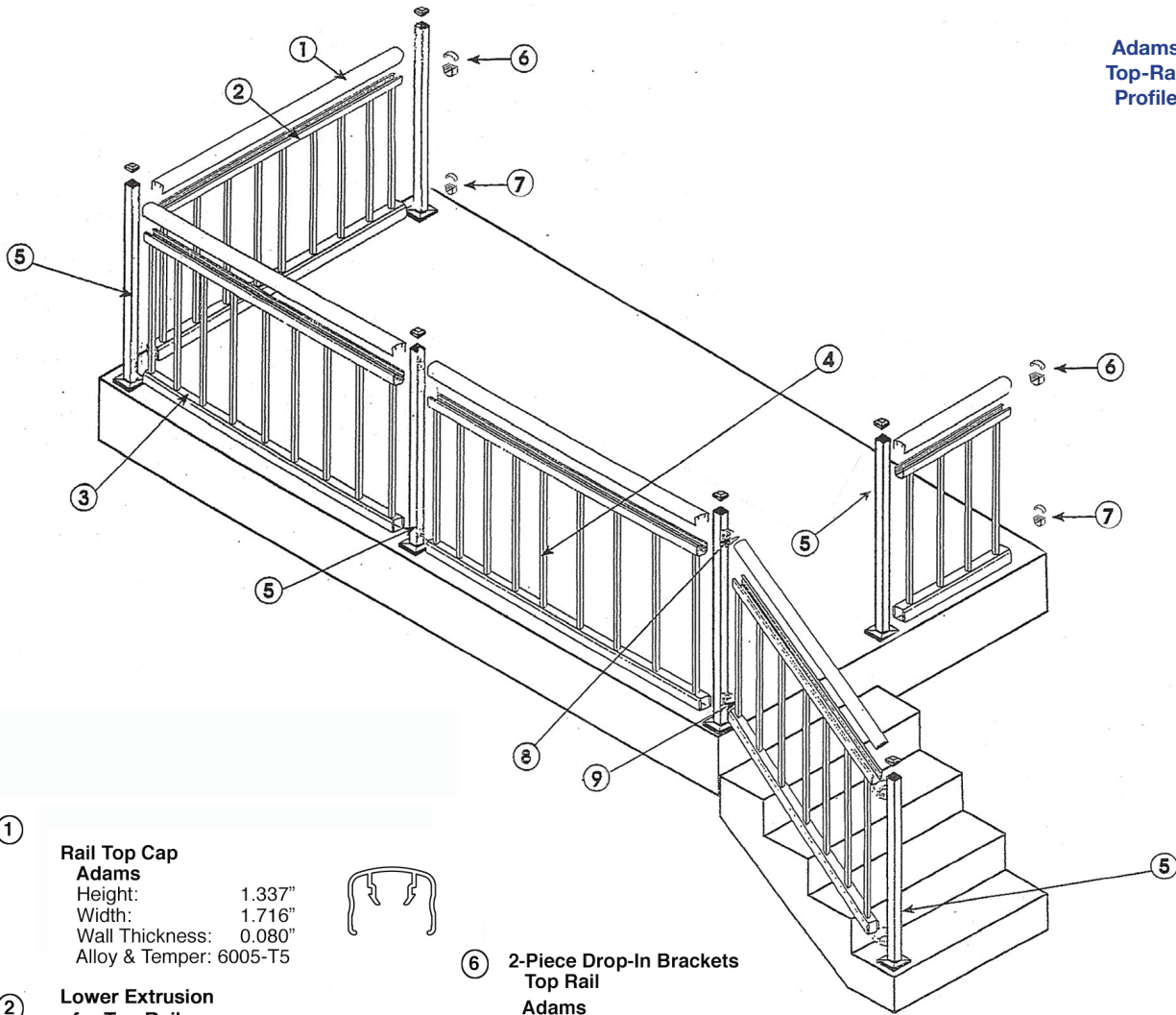

Adams  
Top-Rail  
Profile

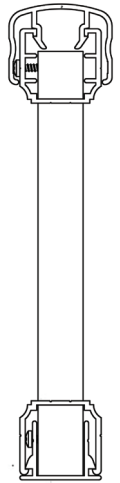

Adams  
Bottom-Rail  
Profile

**1 Rail Top Cap Adams**  
 Height: 1.337"  
 Width: 1.716"  
 Wall Thickness: 0.080"  
 Alloy & Temper: 6005-T5

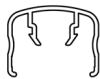

**2 Lower Extrusion for Top Rail Adams**  
 Height: 1.235"  
 Width: 1.352"  
 Wall Thickness: 0.070"  
 Alloy & Temper: 6005-T5



**3 Bottom Rail Adams**  
 Height: 1.375"  
 Width: 1.375"  
 Wall Thickness: 0.070"  
 Alloy & Temper: 6005-T5



**4 Square Picket Adams**  
 Wall Thickness: 0.050"  
 Alloy & Temper: 6005-T5

**5 Post**  
 2 1/2" Sq. x 2 1/2" Sq.  
 Wall Thickness: 0.100"  
 Alloy & Temper: 6005-T5  
 3" Sq. x 3" Sq.  
 Wall Thickness: 0.125"  
 Alloy & Temper: 6005-T5

**6 2-Piece Drop-In Brackets Top Rail Adams**  
 Wall Thickness: 0.200"  
 Alloy & Temper: A-360

**7 2-Piece Drop-In Brackets Bottom Rail Adams**  
 Wall Thickness: 0.200"  
 Alloy & Temper: A-360

**8 Adjustable Rail End Vertical or Horizontal Top Rail Adams**  
 Wall Thickness: 0.200"  
 Alloy & Temper: A-360

**9 Adjustable Rail Ends-Vertical or Horizontal Bottom Rail Adams**  
 Wall Thickness: 0.200"  
 Alloy & Temper: A-360

**Dimensions**

Height	A	B	Panel Hgt.
37"	6"	28"	35"
43"	6"	34"	41"

