

REAL DEALS

PRECISION ISN'T OPTIONAL

»»»» DIAGNOSTIC TOOLS FOR EVERY CODE.



LINE: **ATD** | PART NUMBER: **ULTRAS2**

AUTEL MAXISYS ULTRA S2
DIAGNOSTICS TABLET WITH VCM12



LINE: **TDN** | PART NUMBER: **AD600S**

TOPDON ARTIDIAG600S
COMPACT DIAGNOSTIC SCAN TOOL



LINE: **LAN** | PART NUMBER: **341184002**

LAUNCHTECH X-431
THROTTLE V SCAN TOOL.



LINE: **CJI** | PART NUMBER: **29209**

JALTEST CV DIAGNOSTICS KIT

[CONTENTS]

DIAGNOSTICS	02-06	COMPRESSORS	17-18	POWER TOOLS	25-28
DIAGNOSTICS/SEASONAL	07	TIRE SERVICE	19	SAFETY	29
SEASONAL	08	WELDING	20	HAND & SERVICE TOOLS	30-31
SEASONAL/ SHOP EQUIPMENT	09	CHARGING AND STARTING	21-23	TOOL STORAGE	32
SHOP EQUIPMENT	10-16	CHARGING AND STARTING / AIR AND POWER TOOLS	24		

COMPLETE TPMS SOLUTION FOR COMMERCIAL VEHICLES

TPMS SERVICE FOR COMMERCIAL VEHICLES

Comprehensive TPMS service for Light, Medium, and Heavy-Duty Commercial Vehicles. Industry-leading TPMS-equipped Bus, Truck, and Trailer Coverage, including those made by:

- Fuso
- Freightliner
- MAN
- DAF
- Ford
- Peterbilt
- Mercedes-Benz
- Kenworth
- BYD (Buses)
- EvoBus
- Volvo vehicles and select vehicles equipped with Bendix SmarTire series and WABCO OPTITIRE systems

MaxiTPMS® ITS600 CV

- Part #ATD 700420
- Industry-leading coverage for TPMS-enabled Trucks, Trailers, Buses
 - Program Autel MX-Sensor CVS-A01433 MHz Sensor to replace OE and programmed aftermarket sensors
 - Separate Tractor & Trailer interfaces display up to 46 wheels & 12 axles
 - Includes Deutsch 6 and 9-pin, and UNI-U4 DLC adapters



MX-Sensor CVS-A01

Part #ATD 300170
Includes metal band to attach sensor to rim, compatible with rims sized 14 to 24.5-inches

Part #ATD 300190

Includes fabric band to attach sensor to rim, compatible with rims sized 14-17.5-inches

Part #ATD 300210

Includes fabric band to attach sensor to rim, compatible with rims sized 17.5 to 24.5-inches



AUTEL TPMS SERVICE TOOLS + 1-SENSOR KITS



MaxiTPMS® TS900 Kit \$849⁰⁰

Part #ATD 700300

• TS900 Kit Including 8 1-Sensors



MaxiSYS® MS906PRO2-TS \$1,995

Part #ATD MS906PRO2TS

• TPMS & 40+ Service Functions
• Bi-Directional / ADAS-Capable
• All System AutoSCAN w/ ADAS Identification

MaxiTPMS® ITS600

Part #ATD ITS600

• Compatible with Autel BLE Sensor

• TPMS Service + 4 Service Resets

• Activate, Read & Relearn All Known Sensors

• 4 Programming Methods of Autel 1-Sensors

MaxiTPMS® ITS600K8 Kit \$695⁰⁰

Part #ATD 700130

• ITS600 Kit Including 8 1-Sensors

MaxiTPMS® TS900 \$795⁰⁰

Part #ATD TS900

- 4 MX-Sensor Programming Methods
- Activate, Read, and Relearn ALL known TPMS sensors, including Tesla OE sensors
- Program Autel 1-Sensors and Bluetooth Low Energy (BLE) TPMS sensors
- All Systems Diagnostics with bi-directional controls, Active Tests and Special Functions
- Industry-leading Relearn-by-OBID coverage and extensive Service Menu with 40-plus service tasks

MaxiTPMS® TS508WF TOOL

\$299⁹⁵

Part #ATD 700010

- TS508 Wi-Fi handheld TPMS tool
- Updated software via Wi-Fi
- 4 Programming Methods of Autel 1-Sensors
- Exclusive TPMS Status Screen



MaxiTPMS® TS508WF-8 KIT

\$419⁹⁵

Part #ATD 700020

• TS508WF Kit Including 8 1-Sensors

MaxiTPMS® TS508WF-4 KIT

\$249⁰⁰

Part #ATD 700180

• TS508WF Kit with 4 1-Sensors

MaxiTPMS® TS508WFK-20 Kit

\$579⁰⁰

Part #ATD 700190

• TS508WF Kit with 20 1-Sensors

UNIVERSAL 1-SENSORS - REPLACE 99% OF OE SENSORS ON THE ROAD



MaxiTPMS® 1-Sensor \$29⁹⁵

Part #ATD 1SENSOR

- Combined Frequency: 315MHz & 433MHz
- Interchangeable Valve Stems
- Rubber Valve Stem Included • Sold Individually

MaxiTPMS® Adjustable Angle 1-Sensor \$25⁰⁰

Part #ATD 300030

- 15° Valve Stem Flexibility Fits a Wider Variety of Vehicles
- Combined Frequency: 315MHz & 433MHz
- Rubber Included • Sold Individually



MaxiTPMS® 1-SensorM

\$29⁹⁵

Part #ATD 1SENSORM

• Aluminum Valve Stem Included

MaxiTPMS® Adjustable Angle 1-SensorM \$25⁰⁰

Part #ATD 300020

• Aluminum Valve Stem Included

MaxiTPMS® MX-Sensor BLE \$68⁰⁰

Part #ATD 300100

- Pre-programmed Bluetooth TPMS sensors for Tesla 3/Y/S/X models
- Tesla-ready: Just Fit and Go
- Programmable with Autel TPMS tools for BLE-equipped vehicles

FUTURE PROOF
TESLA-READY
TPMS SENSORS

LASER TIRE TREAD EXAMINER + EASY TO SHARE REPORTS

MaxiTPMS® TBE200 \$449⁰⁰

Part #ATD TBE200

- Tire Tread and Brake Disc Wear Examiner
- Laser-Enabled; No Need to Remove Tire
- 2 Cameras to Document Tire Damage
- Scan Tire Identification Number (TIN)
- Tire health report QR code for easy sharing



LARGE TPMS SENSOR QUANTITIES FOR HIGH-VOLUME LOCATIONS

MaxiTPMS® 1-Sensor Pallet Drop Shipping

- Ideal for large service centers, distributors, and high-volume shops
- OEM-level accuracy, fast programming, and universal vehicle coverage
- Covered by a two-year limited warranty



CALL FOR PRICING

Bulk of 1-Sensor

Part #ATD 1SENSORP

• Includes 8,400 1-Sensors with Rubber Press-In Valves

Bulk of 1-Sensor 240-Pack

Part #ATD 300050P

• Includes 15,360 1-Sensors with Rubber Press-In Valves in packs of 240

Bulk of Adjustable Angle

Part #ATD 300020P

• Includes 12,000 Adjustable 1-Sensors with Rubber Screw-In Valves

Bulk of 1-Sensor 20-Pack

Part #ATD 300010P

• Includes 18,000 1-Sensors with Rubber Press-In Valves in packs of 20

BULK PACKS OF 1-SENSORS



MaxiTPMS® 1-Sensor 20 Packs \$579⁰⁰

Part #ATD 300010

• Package of 20 1-Sensors with Rubber Valves

Part #ATD 300060

• Package of 20 1-Sensors with Aluminum Valves



MaxiTPMS® 1-Sensor 240 Bulk Pack \$6,960

Part #ATD 300050

• Package of 240 Autel 1-Sensors with Rubber Valve Stems

ULTRA S2 SERIES

NEXT GENERATION, HIGH-PERFORMANCE DIAGNOSTICS



The MaxiSYS S2 Series delivers advanced diagnostics with comprehensive coverage, bi-directional tests, coding, and adaptations. Enhanced features include Topology 3.0 for OE-style network analysis, Active Module & Network Analysis to verify ECU communication, and improved live data visualization. New split-screen viewing streamlines workflows by allowing technicians to access multiple functions at once.

DATA-DRIVEN DIAGNOSTICS WITH ENHANCED PID ANALYSIS

Data Visualization: Enhanced graphing capability to visualize multiple parameters to identify the relationship between PIDs and pinpoint system anomalies.

Live Data Fusion: Record and compare value changes across multiple systems.

Parameter Grouping: Multi-PID selection for analyzing related parameters simultaneously. Ideal for engine fault and performance and emissions troubleshooting.

Reference Sampling: Record, store, and review selected PIDs for pre- and post-repair comparison that will flag min, max, and average.

Real-Time, Split-Screen Analysis: Access the oscilloscope directly from the current Live Data screen.



MANAGE, COLLABORATE, & STORE
SIGN UP TODAY: AUTEL.CC/CLOUD-LAND-WEB

MaxiSYS® MS909 S2

Part #ATD MS909S2

\$4,499

MaxiSYS® ULTRA S2

Part #ATD ULTRAS2

\$6,499

MaxiSYS® MS919 S2

Part #ATD MS919S2

\$5,199

MaxiSYS® ULTRA \$5,125⁵⁰

Part #ATD MSULTRA

- Advanced VCI 5-In-1 Device: VCI, Oscilloscope, Multimeter, Waveform
- New VCI Protocols: D-PDU, DoIP/CAN FD, Mega CAN
- Split Screen Multi-Application Function / Dual Wi-Fi Connection



- Topology Module Mapping: Color Coded All System Status Screen (on supported vehicles)

MaxiFLASH® XLINK \$1,395 \$140⁴⁹ For 12 mos.

Part #ATD XLINK

- Enhanced Vehicle Communication Interface
- J2534-pass thru programmer to update modules with OE software
- Supports latest vehicle communications protocols
- Enables on-site and remote module programming



MaxiSYS® MS906 MAX \$1,595

Part #ATD MS906MAX

- 10.1-inch touchscreen wireless professional diagnostics and service tablet
- Extensive vehicle coverage of U.S., Asian and European vehicles, 1996 and newer
- Perform all-systems diagnostics including read & erase codes, view and graph Live Data
- Perform bi-directional Active Tests and Special Functions
- Perform coding and adaptations



MaxiCHECK® MX900 \$505⁰⁰

Part #ATD MX900

- Compatible with U.S. Asian, and European Vehicles, 1996 & Newer
- Read and Erase Codes, View and Graph Live Data, View Freeze Frame Data
- Perform Bi-Directional Active Tests and Special Functions



MaxiHVAC AC909PRO

COMING SOON



From electronically controlled compressors to advanced heat pumps, modern vehicles demand diagnostic tools built for this new era – intelligent, connected, and precise.

- Step by step guided instructions for equipment hookup and the entire repair workflow
- Vehicle-specific overview of A/C specifications and locations, including compressor and refrigerant metering types
- A single screen workflow that incorporates HVAC live pressures and OBD sensor values, including blend door functionality and outlet temperature readings
- First A/C tool that will conclusively identify refrigerant leaks and/or excessive moisture
- Introducing the use of Nitrogen for a pressure leak test "system tightness test" and purge procedures for faster evacuation
- First A/C manifold gauge tool that decouples from the A/C lines while still monitoring low & high pressures





IWA500 + TABLET \$15,000 Part #ATD IWA500T

FACTORY DIRECT

- Broad vehicle coverage: U.S., Asian, and European models from 1975-current
- Guided workflow with server-based vehicle identification and OEM alignment specifications
- Includes 10.1-inch touchscreen wireless MaxiAlign IWA500 tablet with Bluetooth MaxiVCI V200
- Mobile five-camera system delivers real-time, highly accurate measurements. Buy-to-bay portability maximizes shop flexibility and uptime. Faster setups and adjustments with real-time feedback
- Core alignment measurements, including rolling diameter and symmetry values and Advanced measurements such as bump steer, raised vehicle checks, and wheel-off adjustment
- MaxiToe technology centers the steering wheel without a holder. Supports SAS calibration and other OEM-required post-alignment tasks
- Highly detailed, validated alignment reports that are easy to save, print, or share digitally
- Includes four rim clamps with positioning targets and essential accessories

IWA500 + TABLET + CABINET \$16,500 Part #ATD IWA500ACT

• Includes everything in ATD IWA500T plus rim clamp storage cabinet

IA1000 AUTOMATED WHEEL ALIGNMENT & ADAS CALIBRATION SYSTEM

FULLY ROBOTIC FORWARD-FACING CALIBRATIONS

IA1000 AUTOMATED ADAS CALIBRATION & WHEEL ALIGNMENT SYSTEM \$71,500 \$1,536⁴⁶ For **60 mos.** Part #ATD IA1000ASTDT

- Automated Alignment and ADAS Calibration System with robotic forward-facing camera target positioning, laser-guided ACC, blind spot calibrator and AVM mat placement capable of performing four-wheel alignment and ADAS calibrations.
- Includes Autel physical pattern, target kit and calibration components for cameras, radar, LIDAR, Night Vision systems.
- Unit provides one-step robotic and vertical LDW target placement via physical targets or with the included 27-inch attachable monitors, significantly reducing manual operation and setup time.
- Offers comprehensive four-wheel alignment coverage of U.S., Asian, and European vehicles.

The Autel IA1000 is an all-in-one ADAS calibration, wheel alignment, and advanced diagnostics system featuring robotic target positioning and laser-guided accuracy. Designed for efficiency, precision, and repeatability, it's the ideal solution for modern service centers.



MAXISYS IA900 FOUR-WHEEL ALIGNMENT & ADAS CALIBRATION SYSTEM

- IA900 + TABLET \$23,219** Part #ATD IA900WAT
 - IA900 system & Accessories
 - MaxiSYS Ultra ADAS Tablet & MaxiFlash VCI
 - ADAS & Wheel Alignment Software Included
- IA900 LDW + TABLET \$28,146** Part #ATD IA900LDWT
 - IA900 System & Accessories • LDW Targets
 - MaxiSYS Ultra ADAS Tablet & MaxiFlash VCI
 - ADAS & Wheel Alignment Software Included
- IA900 ALL SYSTEMS + TABLET \$39,966** Part #ATD IA900AST
 - IA900 System & Accessories
 - LDW, AVM, NVS, ACC, BSD, LIDAR, RCW Targets
 - MaxiSYS Ultra ADAS Tablet & MaxiFlash VCI
 - ADAS & Wheel Alignment Software Included

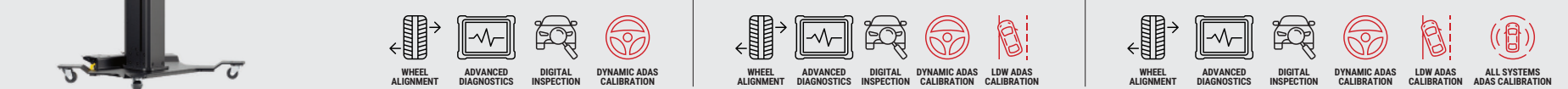

IA700T INSPECTION & ALIGNMENT PRE-CHECK SYSTEM

DRIVE MORE REVENUE TO YOUR ALIGNMENT BAY & IMPROVE CUSTOMER SATISFACTION

Turn your check-in process into a revenue-generating inspection station. With the IA700T, powered by the MS909 S2 Advanced Diagnostic tablet, perform full-system health scans and verify wheel alignment in minutes. Integrate battery testing with the BT506 and tire tread analysis with the TBE200 to generate comprehensive diagnostic, alignment, battery, and tread depth reports, all within a single workflow. The result: a faster check-in process, clearer service recommendations, and more opportunities to increase revenue on every vehicle.

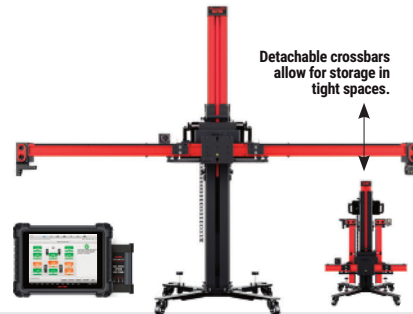

IA700T SYSTEM PACKAGE

\$17,596 \$459⁴³ For **60 mos.**

- Part #ATD IA700T
- Wheel alignment pre-checks drive revenue to your alignment bay
 - Includes MS909 S2 advanced diagnostics tablet and VCI
 - Perform all-systems health checks for maximized revenue potential
 - Pair it with the BT506 to increase battery sales and the TBE200 to generate new tire sales
 - Seamlessly move from bay to bay

ADAS BAY MAX LIFT

ADAS CALIBRATION. SAFER ALIGNMENTS. ONE MAXIMIZED BAY.

ADAS BAY MAX 14K LIFT Call For Pricing

- Part #ATD AULS14ALOR1T
- Flush-mounted Hydraulic Alignment Scissor 14K Lift with Floor Lift Table
 - Enables ADAS Calibrations Within Bay Space
 - Stainless Steel Front Radius Plates and Rear Slip Plates
 - Front & Rear-Opening Runways with Flip Down Wheel Stops

ADAS BAY MAX 12K LIFT Call For Pricing

- Part #ATD AULS12ALOR1T
- 12,000 Pound Lifting Capacity
 - Includes Two 6K Capacity Jacking Beams

ALIGNMENT 14K LIFT Call For Pricing

- Part #ATD AULS14ALOR1
- Surface-mounted Hydraulic Alignment Scissor Lift
 - 14,000 Pound Lifting Capacity
 - Includes Two 7K Capacity Jacking Beams
 - Stainless Steel Front Radius Plates & Rear Slip Plates
 - Front & Rear-opening Runways with Flip Down Wheel Stops

ALIGNMENT 12K LIFT Call For Pricing

- Part #ATD AULS12ALOR1
- 12,000 Pound Lifting Capacity
 - Includes Two 6K Capacity Jacking Beams



FACTORY DIRECT



RADAR CALIBRATION PACKAGE

- \$4,104** Part #ATD ADASRAD1
- Includes Adaptive Cruise Control adapter, Doppler radar box, Continental radar plate, Corner Reflector
 - Enables calibration of radar-based safety systems including ACC and Blind Spot Detection
 - Compatible with Autel Standard Calibration Frame

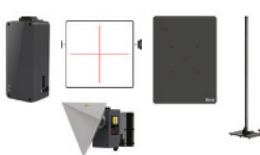

UPGRADE YOUR AUTEL ADAS LDW PACKAGE

ADAS ACCESSORY PACKAGE \$930⁰⁰

- Part #ATD ADASACCESSOR
- Includes Five and Two-Line Lasers and Plumb Bob, Laser Reflector and Laser Assist Mirror, L-Shaped Bracket
 - Enables More Efficient Calibration of Many ADAS Systems Including ACC, BSM, AVM and Some LDW
 - Compatible with Autel Standard Calibration Frame



500-17 Tire Clamps

- \$1,725** \$100⁹⁹ For **24 mos.**
- Part #ATD 50017
- In contrast to standard clamps, tire clamps attach to tires rather than to rims, eliminating potential rim damage.



MaxiSYS® MS909CV \$5,450

- Part #ATD MS909CV
- Class 1-9 Heavy Duty Vehicles
 - Off-highway engine diagnostic coverage for construction and agricultural machinery
 - Bi-directional engine controls for John Deere

MaxiIM® KM100 \$510⁰⁰ Part #ATD KM100

- Program Autel's iKEY universal keys as smart key replacement for 3,000+ vehicles
- 60sec Key generation, Easy key button customization
- Chip Read/Write, Cloning and Frequency Detection
- Extensive IMMO Key programming coverage



MaxiSYS® MS908CVII \$2,999

- Part #ATD MS908CVII
- \$117⁶⁴ For 36 mos.**
- Class 1-9 Heavy Duty Vehicles
 - All System AutoScan, Read and Erase codes, perform bi-directional active tests
 - OE-specific system components, including engine, transmission, and braking systems

MaxiBAS® BT608 \$595⁰⁰ Part #ATD BT608

- Adaptive Conductance Technology: Detects Battery Capacity Reducing Misdiagnosis
- Auto Battery Reset/Print Test Reports Via Built-in Thermal Printer
- AutoSCAN/VINScan for Quick Vehicle Identification & Battery Specifications



MaxiDIAG® MD600CV \$929⁰⁰

- Part #ATD MD600CV
- Wireless Android tablet for Light, Medium and Heavy-duty vehicle diagnostics and service
 - Maintenance and service tasks including DPF Regen, Idle Shutoff, Oil Light Reset, Brake Bleed, Throttle Body Relearn & Injector Coding/Reset

MaxiBAS® BT506 \$195⁰⁰ Part #ATD BT506

- Use with Smartphone or other Smart Device
- Support In-vehicle and Out-of-Vehicle Testing of Passenger Vehicle Batteries
- Test 6- and 12-volt Batteries: 100 - 2000 CCA
- Test 12- and 24- Cranking/Charging Systems
- Test Flooded, AGM, AGM Spiral, EFB & GEL Batteries
- Compatible with CCA, CA, SAE, EN, IEC, DIN, JIS & MCA



**LAUNCH
TECH USA**
FOCUS & INNOVATE

FACTORY DIRECT

THE GLOBAL LEADER IN VEHICLE DIAGNOSTIC SOLUTIONS

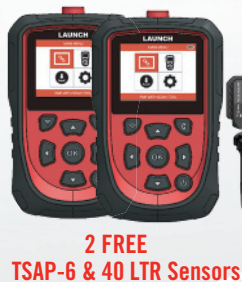

2 FREE
TSAP-6 & 40 LTR Sensors



LAN 702020112TF \$15,639
~~\$343⁸⁶~~ For **60** mos

The Launch X-613 is a compact, portable 3D wheel aligner designed for drive-on style lifts without the need of a traditional setup. Its wireless measurement units and clamps deliver fast, precise four-wheel alignment. Quick to deploy, it works in any workshop without installation, wiring, or calibration.

Comes with full diagnostic capabilities with the X-431 Throttle V Tablet.



X-881 Pro Wheel Aligner LAN 702020046 \$25,945
~~\$570⁴⁷~~ For **60** mos

- The X-881 Pro delivers fast, precise 3D wheel alignment without fixed installation.
- Its advanced cameras and automatic target tracking ensure accurate measurements with minimal effort.
- With Wi-Fi updates, a large monitor, printer, and VIN scanner, it streamlines alignment reporting and saves time.
- Compatible with Two Post Lift



FREE Tread Master

- 0.1mm measurement accuracy
- 180 mm laser measuring width, supporting tires of more specifications.
- Supports single groove depth detection for special patterns of tire
- Scan the entire tread with a line laser, Wi-Fi connection

2 FREE TSAP-6 & 40 LTR Sensors

- Programs LTR TPMS and 35+ aftermarket brands
- 100% TPMS diagnostics coverage including Tesla BLE
- Guided TPMS step by step relearn instructions
- Wireless updating

FREE \$1,499 Value

X-431 Torque AutoHD Pro LAN 301190908 \$4,949
~~\$136⁶⁶~~ For **60** mos



- Power Hardware: Integrated with the new X-431 Torque AutoHD Pro tablet and Smartlink VCI for faster, more accurate diagnostics
- Read and erase DTCs for light, medium, and heavy-duty vehicles (Class 4-8)
- Supports Engines, Transmission, ABS, and Auxiliary systems from Wabco, Bendix, Allison, and more
- Broad Vehicle Compatibility: Works with Cummins, Detroit, Freightliner, Fuso, Hino, International, Isuzu, Kenworth, Peterbilt, Sterling, Volvo and more



FREE J560 PLC Trailer

- Expands the X-431 scan tool's capabilities to include diagnostics for heavy-duty trailers
- Plug-in and go — quick setup with no additional configuration required
- Supports the 7-PIN trailer connector

FREE \$599⁰⁰ Value

FREE HD Multipin Kit



FREE TSAP-6 & 4 LTR TPMS Sensors

X-431 Torque Link LAN 321195101 \$2,858⁹¹
~~\$121¹⁷~~ For **36** mos



- Code Assist by Identifix
- Supports all communication protocols
- X-431 Fix repair information driven by MOTOR (optional)
- Programs LTR TPMS 99% coverage (both valves included)
- Programs over 40 aftermarket TPMS sensor brands
- Secure Gateway: Stellantis, Nissan, Mercedes and VW



FREE TSAP-6 with 10 LTR Sensors

- Programs LTR TPMS and 35+ aftermarket brands
- 100% TPMS diagnostics coverage including Tesla BLE
- Guided TPMS step by step relearn instructions
- Wireless updating

FREE \$599⁰⁰ Value

X-431 Turbo III LAN 321195201 \$1,876⁴⁹
~~\$105⁶⁵~~ For **24** mos



- Supports U.S., Asian, and European vehicles from 1996 to present
- Compatible with DoIP, CAN and CANFD protocols
- Secure Gateway: Stellantis, Nissan, Mercedes and VW
- TECH 2 TECH Remote Support: Code Assist by Identifix®. Instantly access verified DTC fixes and repair solutions from real-world cases

FREE DoIP cable



FREE TSAP-6 & 4 LTR TPMS Sensors

- Programs LTR TPMS and 35+ aftermarket brands
- 100% TPMS diagnostics coverage including Tesla BLE
- Guided TPMS step by step relearn instructions
- Wireless updating

FREE \$625⁰⁰ Value

BST860S Starting & Charging Tester LAN 307020135 \$220⁰⁰



- **International measurement standards:** CCA, JIS, GB, SAE, MCA, CA, DIN, IEC, EN, BCI
- **3s Quick Detect:** Generate the health report within 3 sec. and intuitively display all data in color screen
- **Data Transmission:** The test data can be exported and downloaded via smartphone and diagnostic tools
- **Safety:** No heating, no discharge, no spark, no operating risks
- **Battery & Electrical System:** Ripple detection, Battery test, starter test, charging system test, electric current and voltage test
- **Battery Types:** 6V and 12 V (Lead-acid battery, gel battery and AGM battery)
- **Compatible:** Work on X-431 Throttle V, Torque Link, X-431 Turbo III

FREE Millennium OBD Code Reader

- Built-in DTC Lookup Library
- Multilingual Support
- Supported Protocols: ISO9141-2, ISO14230-4, SAEJ1850, ISO15765-4
- Additional Features: O2 Sensor Test, DTC Lookup Library, Real-Time Graphing, Battery Voltage Test

FREE \$79⁰⁰ Value

BST360 Bluetooth Battery Tester LAN 301180946 \$87⁹⁹



- **International measurement standards:** CCA, JIS, GB, SAE, MCA, CA, DIN, IEC, EN, BCI
- **3s Quick Detect:** Generate the health report within 3 sec. and intuitively display all data in color screen
- **Data Transmission:** The test data can be exported and downloaded via smartphone and diagnostic tools
- **Safety:** No heating, no discharge, no spark, no operating risks
- **Battery & Electrical System:** Ripple detection, Battery test, starter test, charging system test, electric current and voltage test
- **Battery Types:** 6V and 12 V (Lead-acid battery, gel battery and AGM battery)
- **Compatible:** Work on X-431 Throttle V, X-431 Torque Link, X-431 Turbo III



TOPDON®

FIX LIKE
A PRO.

FACTORY DIRECT

Diagnostic Tools



\$4,509
#TDN PXMAX

Phoenix MAX

13.3" OE-Level Scan Tool, Docking Station, Cloud-Based Programming & 4 Channel Oscilloscope

- Includes 1 year HD software
- 4-channel oscilloscope included
- Topology mapping system view
- Advanced ECU programming support
- ADAS calibration compatibility

#TDN PXMAXBASIC *Does not include scope \$4,000.00



\$2,309
#TDN PXSMART

Phoenix Smart

10.1" OE-Level Scan Tool, Cloud-Based Programming, Adv Protocols

- OE-level diagnostics and coding
- 10.1" wireless Android tablet
- Topology mapping support
- Cloud-based ECU programming capability
- Heavy-duty software available separately



\$839.99
#TDN PXLITE3

Phoenix Lite 3

8" OE-Level Scan Tool, Full-System Diagnostics, Wireless VCI

- Full-system diagnostics and bi-directional control for 168+ makes
- 35+ maintenance and reset functions
- Wireless Bluetooth VCI communication
- Supports CAN-FD protocol and AutoVIN

EXPAND WITH HEAVY-DUTY SOFTWARE & ACCESSORIES



HD Non-16 Pin Cable Kit
\$154
#TDN HDCKIT



HD CAT 14 Pin Cable
\$45.99
#TDN HDCAT14



HD Kubota 4 Pin Connector
\$27.99
#TDN HDKUB4P

RLink J2534

OEM J2534 Pass Thru

- Supports J2534, D-PDU, and DoIP protocols
- Compatible with major OEM programming software
- USB communication interface
- Designed for ECU programming and flashing



\$224
#TDN RLINKJ2534

UltraDiag

8" Scan Tool & Key Programming w/ Bi-Directional Controls

- 30 Reset Functions
- AutoVIN & AutoScan
- Vehicle Coverage Lookup
- VCI Bluetooth Wireless Diagnostics
- 2 yrs free software updates
- Full System Diagnostics for 100+ Brands



\$699
#TDN ULTRADIAG

ArtiDiag900BT

7" Bluetooth Scan Tool w/Serv Functions & Bi-Directional Controls

- 28 Advanced Service Functions
- ECU coding
- Wireless Bluetooth VCI
- Comprehensive scans on over 130 brands
- Comprehensive functions including AutoVIN, FCA Gateway Access, and live data displays



\$499.99
#TDN AD900BT

ArtiLink500B

2-in-1 Code Reader & Battery Tester w/Data Graphing

- Reads and clears OBDII diagnostic codes
- Displays live data stream information with automatic recording
- Integrated battery testing capability for 12V/24V Lead-Acid batteries
- Free lifetime software updates



\$65.99
#TDN AL500B

ArtiDiag600S

5" Scan Tool - PCM/TCM/ABS/SRS, Lifetime Updates, 9 Serv Funcs

- CAN & CAN-FD Support
- AutoVIN vehicle identification
- Complete diagnostics for engine, transmission, airbag, and ABS
- 9 maintenance functions including Oil, EPB, SAS, BMS, DPF, and TPMS resets
- Live data monitoring with multi-stream display



\$184.99
#TDN AD600S

ArtiDiag HD

5" Heavy-Duty Scan Tool

- 60+ HD brands supported
- Heavy-duty vehicle diagnostics coverage
- Full-system scanning capability
- DPF regeneration and service functions
- Compact handheld diagnostic platform



\$619.99
#TDN ADHD

TOPSCAN PRO

Pocket-Sized Bluetooth Scan Tool w/ Bi-Directional Controls

- Bluetooth wireless OBDII connection
- Smartphone-based full-system diagnostics for 120+ makes
- Live data monitoring and graphing
- Supports service reset functions



\$99
#TDN TOPSCANPRO

TC005

Handheld High-Resolution Thermal Imaging Camera

- Temperature measurement range up to 1022°F (550°C)
- Thermal sensitivity <40 mK for small temperature differences
- Multiple measurement modes with on-device image storage



\$365
#TDN TC005

TC002C DUO

USB-C Smartphone Thermal Camera

- 25Hz frame rate for real-time thermal imaging
- 256x192 infrared resolution sensor
- USB-C connection for iOS, Android, and Windows
- TISR image enhancement and analysis via mobile app



\$253.99
#TDN TC002CDUO

TS004

Thermal Imaging Monocular with 13mm Lens

- 256x192 infrared detector with 50Hz refresh rate
- 13mm objective lens with detection up to 450 yd
- 1x-8x digital zoom with multiple color palettes
- 5000mAh battery with up to 11 hours runtime



\$389
#TDN TS004

Invented for life



Introducing the All-New ADS 10X Plus

Built on Trust, Powered by Bosch



Call Store For Pricing
BSD ADS10XPLUS



Try it risk-free for 30-days.
If it doesn't earn its place
in your bay, send it back
hassle-free.

Designed in North America, for North America:

- Specifically engineered for the vehicles you see every day.

98.7% Vehicle Coverage and Growing:

- Service more vehicles with confidence.
- Dedicated to monthly updates for the latest coverage, calibrations, secure access, and more.

Seamless Solutions for Secure Gateway Access:

- Unlock access to OEM Secure Gateway Modules (SGW) for:
 - FCA/Stellantis • Hyundai/Kia
 - Mercedes • VW/Audi
 - Nissan
- (Access solution varies by OEM.)

New Generation GVCI:

- Future-proof J2534-compliant GVCI processes data on 3 CAN channels simultaneously.
- High-speed communication wirelessly without extra cables or reduced data rates.

Bigger Screen, Sleek Design, Better Connection:

- Large, 11-inch display for better visibility and less scrolling.
- Lightweight design and ergonomic hand strap for confident, one-hand operation.
- Improved wireless connectivity ensures faster throughput.

Faster Speed, More Storage:

- Featuring a 2.4 GHz Octa-Core processor, 8GB RAM, and 128GB of internal storage
- Delivers lightning-fast performance, minimizing wait times and maximizing billable hours.

Free Enhanced Software Subscription

- Enhanced Subscription includes on-tool and desktop access to unfiltered Motor TruSpeed Repair, an OEM service and repair database and access to over 700,000 wiring diagrams.
- Redeem at www.BoschRebates.com before October 31, 2026 promo code NAPA_ENH-Upgrade



Integrated display stand also serves as steering wheel hook.
Convenient hand straps for ease and comfort.

INNOVA

DIAGNOSTICS MADE EASY

INNOVA® 7111
OE-LEVEL DIAGNOSTICS
BK 7000120

\$548⁰⁰

- **FREE** access to RSPRO built-in
- Secure Gateway (SGW) access on 2018 & newer FCA vehicles

- OEM/Enhanced Diagnostics
- Active Tests and Special Functions
- Removeable VCI – Wireless Diagnostics



7" Touch Screen

INNOVA® SDS43
OE-LEVEL DIAGNOSTICS
BK SDS43

\$242⁰⁰

- **FREE** access to RSPRO Companion App
- OEM Diagnostics

- Active Tests and Special Functions for ECM/PCM, TCM
- Reads Tire Pressure, Service Check & Warning Light
- Multiple Report Types



4.3" Non-Touch Screen



Customizable reports, pre & post scans, repair tips, fixes and more.

INNOVA® SD35
DIAGNOSTIC TOOL
BK SD35

\$227⁰⁰

- **FREE** access to RepairSolutions2
- All Systems Scan
- Graph & Record Live Data

- Read & Clear OEM Engine, Transmission, ABS, & SRS
- Maintenance Light Reset/ Oil Level/Oil Life



3.5" Non-Touch Screen



A companion app with verified fixes and the required parts for repair.

INNOVA® 3381
2.8" LCD INSPECTION
CAMERA
BK 3381

\$173⁰⁰

- Record video and audio
- 8 Bright Illumination LEDs

- 2.8" IPS Screen with wide viewing angles
- IP67 Rated Submersible Lens allows safe inspection of areas contaminated by oil or water

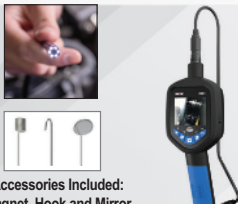

Accessories Included:
Magnet, Hook and Mirror

INNOVA® 5420
POWERCHECK POWERED
CIRCUIT TESTER
BK 7000121

\$110⁰⁰

- Swivel-head probe reaches tight spaces for quick checks in crowded engine bays and under-dash areas

- Safely test and apply power/ground to activate components, verify wiring, and pinpoint faults faster



SUPPLY POWER AND GROUND

6V-24V



Jaltest CV is the one-stop solution for technicians who work on all makes:

- Trucks, trailers, buses, and pick-ups
- OE capabilities such as recalibrations, regens, and resets.
- Technical information, wiring diagrams, and repair guides.

jaltest cv



\$7,000
CJI 29209

\$1,009
CJI 293208
(Upgrade only)

The Jaltest CV Kit can be upgraded with coverage for OHW vehicles.

jaltest DIAGNOSTICS

BOOK A DEMO and learn more



jaltest OHW

Jaltest OHW is a solution for technicians who work on construction equipment:

- More than 100 manufacturers.
- OE capabilities such as DPF regens or injector coding.
- Technical information, wiring diagrams, and repair guides.



\$4,509
CJI 29211



GEARWRENCH

TO CLAIM YOUR FREE ITEMS

Scan the QR Code on this page



BUY 10" PRO COMMAND WIRELESS BIDIRECTIONAL DIAGNOSTIC TABLET

- 51 Pro Vehicle Reset/Relearn Functions
- Advanced System Intelligence
- Full Bidirectional Control
- 3-Year FREE Software Updates

Item No. APX GWSMART10



GET FREE

5" HANDHELD BI-DIRECTIONAL DIAGNOSTIC TOOL

Item No. APX GWSMART05

OR

HIGH-DEFINITION FLEXIBLE INSPECTION BORESCOPE

Item No. APX GWSCOPE



BUY 7" WIRELESS BI-DIRECTIONAL DIAGNOSTIC TABLET

- 38 Pro Vehicle Reset/Relearn Functions
- Topology Mapping
- Full Bidirectional Control
- 3-Year FREE Software Updates

Item No. APX GWSMART07



GET FREE

HIGH-DEFINITION FLEXIBLE INSPECTION BORESCOPE

Item No. APX GWSCOPE

NEW UNIVERSAL TPMS & DIAGNOSTIC TOOL

- Clear TPMS Warning Lights
- 315/433 MHz Dual Frequency
- Program Up To 8 Sensors Simultaneously
- FREE Lifetime Software Updates

Item No. APX GWTTPMS



NEW UNIVERSAL PROGRAMMABLE TPMS SENSORS

- Compatible With 99% of Vehicles
- Activates, Relearns & Programs 315 MHz & 433 MHz Sensors
- 100% ID Cloneable Sensor



DIAGNOSTIC TOOLS

Item No.	Description	Price	Item No.	Description	Price
APX GWSCAN	Everyday Diagnostic Tool Bluetooth OBDII Tester	\$69.99	APX GWTTPMSM20PK	Universal Programmable Metal TPMS Sensor - 20 Pack	\$380.00
APX GWSMARTBT	Professional Bi-Directional Diagnostic Scan Tool	\$149.00	APX GWTTPMSM4PK	Universal Programmable Metal TPMS Sensor - 4 Pack	\$84.99
APX GWSMART07	7" Wireless Bi-Directional Diagnostic Tablet	\$649.00	APX GWTTPMSR	Universal Programmable Rubber TPMS Sensor	\$24.99
APX GWSMART05	5" Handheld Bi-Directional Diagnostic Tool	\$399.00	APX GWTTPMSR20PK	Universal Programmable Rubber TPMS Sensor - 20 Pack	\$380.00
APX GWSMART10	10" Pro Command Wireless Bi-Directional Diagnostic Tablet	\$2,249	APX GWTTPMSR4PK	Universal Programmable Rubber TPMS Sensor - 4 Pack	\$84.99
APX GWTTPMS	Universal TPMS & Diagnostic Tool	\$175.00	APX GWSCOPE	High-Definition Flexible Inspection Borescope	\$99.99
APX GWTTPMSM	Universal Programmable Metal TPMS Sensor	\$24.99			

PORTACOOL® APEX SERIES

Maximize PRODUCTIVITY with Smarter Shop Cooling



Models Shown (L to R): POR PACA65001A1, POR PACA40001A1, POR PACA20001A1, POR PACA12001A1, POR PACA07001A1, POR PACA05001A1

Control Your Climate with COOLSYNC™

- FAN SPEED
- WIND DIRECTION
- WATER CONTROL
- SCHEDULING
- GROUP SYNCING



Sync your Portacools to your smartphone for intelligent control.

Product SKU	Cooling (Sq. Ft.)	Velocity (MPH)	Air Flow Reach (Ft.)	Dimensions (HxWxD)	Price
POR PACA05001A1	500	40	55	46Hx22Wx19.5D	\$1,099 \$110 ^{MS} for 12
POR PACA07001A1	700	37	60	52Hx27Wx24D	\$1,599 \$161 ^{MS} for 12
POR PACA12001A1	1200	25	40	58Hx42Wx26D	\$2,399 \$131 ^{MS} for 24
POR PACA20001A1	2000	28	60	68Hx54Wx30D	\$3,199 \$102 ^{MS} for 48
POR PACA40001A1	4000	25	50	77Hx63Wx33D	\$3,799 \$104 ^{MS} for 60
POR PACA65001A1	6500	24	45	90Xx78Wx39D	\$4,999 \$138 ^{MS} for 60

Shop Smart. Stay Cool.
Contact your NAPA rep to order and keep your shop performing at its peak.

MAHLE

<p>\$1,855</p> <p>\$101⁹¹ For 24 mos</p> <p>10-Ton High-Rise Vehicle Support Stand CVS-10H RTI 4858010900</p> 	<p>\$2,405</p> <p>\$131⁹⁹ For 24 mos</p> <p>Brake Fluid Exchange Machine, w/ adapter set BFX-20 RTI 4258001400</p> 	<p>\$2,649</p> <p>\$103⁹¹ For 36 mos</p> <p>\$3,469</p> <p>\$111¹⁷ For 48 mos</p> <p>Vehicle Filter Crusher AFC-9 - 9" chamber RTI 4858008100 CFC-16 - 16" chamber RTI 4858008200</p> 	<p>\$3,579</p> <p>\$114⁹⁹ For 48 mos</p> <p>Coolant Exchange RTI 4708003100</p> 
<p>\$4,289</p> <p>\$118⁴³ For 60 mos</p> <p>Air Conditioning Service System Mid-Range R134a ACX2150 RTI 4608044500</p> 	<p>\$4,955</p> <p>\$136⁸² For 60 mos</p> <p>Air Conditioning Service System - Hybrid Certified High Performance R134a ACX2180H RTI 4608044800</p> 	<p>\$5,293⁹⁹</p> <p>\$128⁷⁴ For 60 mos</p> <p>Air Conditioning Service System High Performance R134a ACX2180 RTI 4608044700</p> 	<p>\$5,775</p> <p>\$140⁴¹ For 60 mos</p> <p>Automatic Transmission Fluid Exchange w/Standard Vehicle Adapter set ATX-280 RTI 4008002300</p> 
<p>\$6,599</p> <p>\$160⁴⁴ For 60 mos</p> <p>Air Conditioning Service System Mid-Range R1234yf ACX2250 RTI 4608044600</p> 	<p>\$7,139</p> <p>\$173⁵⁷ For 60 mos</p> <p>Air Conditioning Service System High Performance R1234yf ACX2280 RTI 4608044900</p> 	<p>\$51,230</p> <p>\$1,100⁸⁸ For 60 mos</p> <p>\$62,250</p> <p>\$1,337⁶⁹ For 60 mos</p> <p>Commercial Vehicle Mobile Column Lift CML-7x4 - 28 ton (56,000 lb.) Wireless (Set of 4) RTI 4858009500 CML-9x4 - 38 ton (76,000 lb.) Wireless (Set of 4) RTI 4858009900</p>  <p>FACTORY DIRECT</p>	

MASTER

THE PROFESSIONAL'S CHOICE SINCE 1953



MHR MAC20F	Master Shop Fan	20"	\$109.99	MHR MAC30BCT	Master Shop Fan	30"	\$289.99
MHR MAC18WB	Wall Fan	18"	\$144.99	MHR 36MACAPBDF	Shop Fan	36"	\$419.99
MHR MAC18WW	Wall Fan	18"	\$144.99	MHR 42MACAPBDF	Shop Fan	42"	\$459.99
MHR MAC24DCT	Master Shop Fan	24"	\$174.99	MHR MAC36BDF	Belt Drive Barrel Fan	36"	\$464.99
MHR MAC24W	Wall Fan	24"	\$189.99	MHR 48MACAPBDF	Shop Fan	48"	\$499.99
MHR MAC24WOSC	H Vel Oscg Mount Fan	24"	\$199.99	MHR MAC42BDF	Shop Fan	42"	\$544.99
MHR MAC30P	Master Shop Fan	30"	\$239.99	MHR MAC48BDF	Shop Fan	48"	\$639.99





TURN WASTE INTO FREE HEAT



CALL FOR BEST PRICING

EnergyLogic turns waste oil into heat, creating a safe avenue for unusable oil and helping turn a burden into **future savings.**

Part No.	Waste Oil Heater Complete Systems
11075104	75H Heater - Waste Oil 75,000 BTU w/ 10 Gal Tank & Flue Kit
01140103	140H Heater - Waste Oil 140,000 BTU w/ 250 Gal Tank SW & Flue Kit
01200104	200H Heater - Waste Oil 200,000 BTU w/ 250 Gal Tank SW & Flue Kit
01350104	350H Heater - Waste Oil 350,000 BTU w/ 250 Gal Tank SW & Flue Kit

LEARN MORE AND START YOUR ORDER TODAY
energylogic.com or (844) 534-8053



Mastercool[®]
"World Class Quality"

ARCTIC COMMANDER 2.0

RECOVERY / RECYCLE / RECHARGE MACHINES

EXCEEDS SAE STANDARDS FOR PURITY AT 98.5%

- 10" COLOR TOUCH SCREEN to navigate with ease
- WIFI CAPABILITY allows for real time, interactive communication
- INDICATOR LIGHT for visual confirmation of machine status
- 4" ANALOG GAUGES are class 1 rated and color coded



ARCTIC COMMANDER 2.0:
2 YEAR LIMITED WARRANTY
ON PARTS, 1 YEAR ON LABOR

NTE COMM4100
R1234YF & HYBRID
RECOVERY/RECYCLE/RECHARGE
MACHINE

- Refrigerant Identifier
- Refrigerant Database
- One Used Oil Bottle
- SAE J2843 Certified
- Hose Flushing
- Thermal Printer
- Status Light
- Made In USA

\$8,880

\$215⁹⁰ For 60 mos



NTE COMM2100
R134A FULLY AUTOMATIC
RECOVERY/RECYCLE/RECHARGE MACHINE

- Automatic Oil Injection
- Two Sealed Bellows Design Bottles, One Used Oil Bottle
- Status Light
- Refrigerant Database
- SAE J2788 Certified
- Made In USA

\$5,845

\$142¹¹ For 60 mos



BK 7003701	27 Piece Master Radiator Pressure Test Kit	\$409.00
NTE 781409	R134a Brass Manifold Gauge Set w/ 60" Hoses, Couplers	\$175.00
NTE 783420	R134a Brass Manifold Gauge Set w/ 72" Hoses, Couplers	\$179.00
NTE 781400	R134a Aluminum Manifold Gauge Set w/ 72" Hoses, Couplers	\$205.00
NTE 783417	R134a Aluminum Manifold Gauge Set w/ 60" Hoses, Couplers, Can Tap Valve	\$209.00
NTE 781901	3 CFM Single Stage Vacuum Pump	\$300.00
NTE 783966	R134a/R1234yf Aluminum Manifold Gauge Set w/ 60" Hoses, R134a & R1234yf Couplers, Adapters	\$390.00
NTE COMM1100	R134a Semi-Auto R/R/R Machine	\$121.81 For 60 mos \$5,010
NTE 69372	R134a/R1234yf Complete A/C Recovery System	\$170.09 For 12 mos \$1,689.00

WWW.MASTERCOOL.COM | PHONE: 973-252-9119



Combining Simple Operation With Superior Accuracy

R-134a System Features	ROB 34288NI	ROB 34788NI	ROB 34788NI-H	ROB 34998
Fully Automatic Function: Program to recover, vacuum, leak test and charge without operating panel valves	Manual valves	✓	✓	✓
Automatic fluid drain/inject	Oil drain	Oil drain / 1 inject bottle	Oil drain	Oil drain / 1 inject bottle
A/C System Flush: Flushes a vehicle's A/C system with refrigerant, eliminating any residual oil or other liquid	-	-	✓	✓
Visual & Audible Alarm: Notifies the user when service is complete, or if a problem has occurred	-	✓	✓	✓
Vacuum Leak Test: Monitors level after evacuation, informs of possible leak	-	✓	✓	✓
Automatic Refrigerant Refill: Maintains a user-selectable amount of refrigerant in an internal vessel	-	✓	✓	✓
Multilingual display	4.3" color LCD	4.3" color LCD	4.3" color LCD	10.5" hi-res touch screen
WiFi and Bluetooth connectivity with Android OS	-	-	-	✓



Tracer Gas Leak Detector Service Kit

- Accurately find both small and large AC Leaks with Trace Gas Testing.
- No need to waste expensive refrigerant testing these systems.

\$499.00

ROB LD9TG - Tracer Gas Leak Detector

\$899.00

ROB LD9TGKIT - Includes Regulator, hoses and 134A & 1234YF service connectors. (pictured above)



ROB 34998

R-1234yf Service Essentials

Fully SAE compliant R-1234yf recovery machine with integrated refrigerant identifier to avoid cross-contamination and confirm refrigerant purity



Too Low To Advertise

ROB AC12349
Connected RRR with 10.5" hi-res touch screen features built-in training videos and wireless printing



Too Low To Advertise

\$166⁷⁶ For 60 mos

ROB AC12344
Fully automatic RRR with multilingual 4.3" color LCD display
ROB AC12344SL Scale Lock available for mobile repair



R-1234yf units will not automatically inject oil. PAG and POE oil injectors are required to measure and inject oil back into the system



Syringe-type injectors

\$179.00

ROB 18465 - R1234YF oil injector, PAG labeled

\$179.00

ROB 18470 - R1234YF oil injector, POE labeled
Not recommended for UV dye injection.

Updated leak detector capable of detecting R-1234yf and R-134a to properly perform service and avoid costly leaks

Refrigerant leak detector for R 1234YF & R 134A

\$469.00

ROB LD7 Premium
Sweep, bar graph and line graph modes
Audible detection alert and patented three LED UV lights
Sensor life up to 10 years for trusted, reliable leak detection

Also available
\$299.00

ROB LD3 Economy

\$439.00
ROB LD5 Select



TSS TOTAL SHOP SOLUTIONS

FACTORY DIRECT

TOTAL SHOP SOLUTIONS is a family of brands that brings together best-in-class automotive repair products.

WHEEL BALANCERS | WHEEL ALIGNERS | TIRE CHANGERS | BRAKE LATHES | AUTOMOTIVE LIFTS | MORE

CL Challenger Lifts

PRODUCT COLOR CODE

02

04

06

2-POST LIFTS

- HEAVY DUTY** 20K HEAVY-DUTY
2-STAGE HEAVY-DUTY ARMS
CL-CL20(02) / CL-CL20(04) / CL-CL20(06) **\$30,214**
- HEAVY DUTY** 16K HEAVY-DUTY
3-STAGE HEAVY-DUTY ARMS
CL-CL163S(02) / CL-CL163S(04) / CL-CL163S(06) **\$24,938**
- HEAVY DUTY** 12K 3-STAGE ARMS
ADJUSTABLE WIDTH **EV SERVICE READY**
CL-CL12A(02) / CL-CL12A(04) / CL-CL12A(06) **\$11,724**
- HEAVY DUTY** 12K 3-STAGE ARMS
LOW CEILING **EV SERVICE READY**
CL-CL12ALC(02) / CL-CL12ALC(04) / CL-CL12ALC(06) **\$11,895**
- NEW** 12K HEAVY DUTY
3 STAGE ARMS FRONT & REAR
CL-LE123S(04) / CL-LE123S(06) **\$9,724**
- HEAVY DUTY** 15K HEAVY DUTY
2-STAGE FRONT & REAR ARMS
CL-E15(04) / CL-E15(06) **\$15,103**
- 10K VERSYMMETRIC®
3 STAGE ARMS - ADJUSTABLE
CL-CL10AV3(02) / CL-CL10AV3(04) / CL-CL10AV3(06) **\$7,723**
- 10K VERSYMMETRIC®
3-STAGE FRONT 2-STAGE REAR ARMS
CL-VLE10(04) / CL-VLE10(06) **\$5,733**
- NEW** 10K VERSYMMETRIC®
3 STAGE ARMS COMPLETE
WITH STACK ADAPTERS AND EV KIT
CL-CL10AV3EV2 / CL-CL10AV3EV4 / CL-CL10AV3EV6 **\$8,301**

NEW
10K VERSYMMETRIC®
3-STAGE ARMS
AVAILABLE
WITH EV KIT

ALL COLORS AVAILABLE

\$8,742

MODEL# CL-CL10AV3EV6

4-POST LIFTS

- 15K LIFT / ALIGNMENT OPEN-FRONT **\$31,380**
CL-AR4115EAO(02) · STANDARD LENGTH, 183" WB
- CL-AR4115XAO(02) · EXTENDED LENGTH, 210.5" WB **\$31,967**
- 14K LIFT / GENERAL SERVICE **\$10,393**
CL-4P14EFX(02) · STANDARD LENGTH, 182.5" WB
- CL-4P14XFX(02) · STANDARD LENGTH, 210" WB **\$10,985**

7.5K ROLLING JACK
\$4,525 CL-RJ7

SCISSOR LIFTS

14K HD SCISSOR ALIGNMENT LIFT PACKAGE (2 7K CAPACITY ROLLING JACKS, STAINLESS STEEL TURN PLATES, AUTO ON-OFF LIGHT FEATURE, AND AIRLINE KIT)
CL-CLSX14 **\$44,400**

NEW \$4,768 ACCESSORY CART

CL ACCCARTPKG
This new accessory cart comes equipped with stack adapters, EV footpads, pad replacements, rubber spacers, GM foot pads, and 3-Stage arms for low-profile vehicles.



MOBILE COLUMNS

- 5K MED. DUTY (SET OF 4)
CL-CLMM5000 · 20K CAPACITY **\$37,796**
- HEAVY DUTY** 14K MOBILE COLUMN
NOW SOLD INDIVIDUALLY
CL-CLHM1401 · 14K CAPACITY EACH **\$12,649**
- HEAVY DUTY** 19K MOBILE COLUMNS
NOW SOLD INDIVIDUALLY
CL-CLHM1901 · 19K CAPACITY EACH **\$14,093**
- NEW** 20K HD BUMPER LIFT
CL-CLHMBL20B · 20K CAPACITY **\$10,485**

QUALITYLIFTS

10K 2-POST \$4,999

- CL EQ10
BLACK
10,000 LB. LIFT
- DROP-IN PAD ALLOWING LIFTING FROM PINCH WELD OR FRAME
 - PREMIUM SHEATHED LOCK RELEASE CABLE
 - 3 STAGE FRONT & 2 STAGE REAR ARMS

6K MID-RISE LIFT \$4,046

- CL QMR6
BLACK
- SIX LOCKING HEIGHTS
 - PORTABLE



SCAN FOR MORE TOTAL SHOP SOLUTIONS DISCOUNTED PRODUCTS

FACTORY DIRECT



WHEEL ALIGNERS

- geoliner® 770** AC400 Clamps & Vin Code Reader
HOF-EEWA752BV3 ~~\$637⁵³~~ For 60 mos. ~~\$30,680~~ **\$28,995**
- geoliner® 678** AC400 Clamps & Vin Code Reader
HOF-EEWA715TBV3 ~~\$549⁵⁸~~ For 60 mos. ~~\$26,460~~ **\$24,995**
- geoliner® 660** AC200 Clamps
HOF-EEWA712TH3 ~~\$439⁶⁴~~ For 60 mos. ~~\$21,170~~ **\$19,995**
- geoliner® 609**
HOF-EEWA741TH3 ~~\$373⁶⁸~~ For 60 mos. ~~\$22,550~~ **\$16,995**

TIRE CHANGERS

- HEAVY DUTY monty® 3850 TRUCK TIRE CHANGER**
HOF-EEWH703AUA ~~\$361⁰⁶~~ For 60 mos. ~~\$19,620~~ **\$16,421**
- monty® 3550EM SMARTSPEED™**
HOF-EEWH747B ~~\$281⁴⁴~~ For 60 mos. ~~\$15,240~~ **\$12,800**
- monty® 1685**
HOF-EEWH792AUC ~~\$239⁵⁶~~ For 60 mos. ~~\$11,780~~ **\$9,853**

WHEEL BALANCERS

- ARMORED SERIES 2400P**
HOF-EEWB784AUA1 ~~\$257²⁷~~ For 60 mos. ~~\$13,980~~ **\$11,700**
- geodyna® 8200P**
HOF-EEWB766BEA ~~\$312²³~~ For 60 mos. ~~\$18,850~~ **\$14,200**
- geodyna® 7600P**
HOF-EEWB765AP ~~\$228⁸⁹~~ For 60 mos. ~~\$11,220~~ **\$9,415**
- geodyna® 980L WITH LIFT**
HOF-EEWB710DW ~~\$333⁷⁶~~ For 60 mos. ~~\$18,080~~ **\$15,179**

ALIGNMENT LIFTS

- 15K 4-Post Standard PKG**
HOF-EELR706APKG ~~\$687⁴⁹~~ For 60 mos. ~~\$33,250~~ **\$31,267**
- 15K 4-Post Strd. L&L PKG**
HOF-EELR706LLPKG ~~\$759⁷¹~~ For 60 mos. ~~\$36,780~~ **\$34,552**
- 15K 4-Post Extended PKG**
HOF-EELR708APKG ~~\$719⁷³~~ For 60 mos. ~~\$34,810~~ **\$32,733**
- 15K 4-Post Extended L&L**
HOF-EELR708LLPKG ~~\$785⁷¹~~ For 60 mos. ~~\$38,040~~ **\$35,735**
- NEW 18K 4-Post Alignment**
HOF-FPA18210PKGA ~~\$820⁶⁸~~ For 60 mos. ~~\$44,580~~ **\$37,325**

HOFMANN®



HOF-EEWA715TBV3



HOF-EEWH792AUC



HOF-EEWB784AUA1



ECOTECHNICS A/C

- ~~\$10,810~~ ~~\$237⁶⁸~~ For 60 mos. **HOF EEAC800**
ECO Dual Gas 134A & 1234YF Hybrid Ready
- ~~\$6,586~~ ~~\$160¹⁴~~ For 60 mos. **HOF EEAC830B**
ECO Next 1234-YF HFO Hybrid Ready
- ~~\$4,939~~ ~~\$136³⁸~~ For 60 mos. **HOF EEAC820B**
ECO Next 134-A Hybrid Ready

monty® 1685

BUILT TO WITHSTAND HIGH-VOLUME, INDUSTRIAL TIRE SERVICE ENVIRONMENTS

TIRE CHANGER & BALANCER PACKAGE

monty® 1270 with geodyna® 7100
HOF HOFCOMBO1 HOF-EEWH764AU1 WITH HOF-EEWB761A

*Set-up and training not included

\$6,702

~~\$162⁹³~~ For 60 mos.

EZ ADAS RECALIBRATION SYSTEM

PRECISION, OEM COMPLIANT CALIBRATION SOLUTION

- LASER TECHNOLOGY
- UP TO 40% FEWER STEPS
- INTEGRATES WITH EXISTING SCAN TOOL
- SPACE SAVING, FOLD UP DESIGN
- INCLUDES MOST OEM TARGETS

\$12,846

~~\$282⁴⁷~~ For 60 mos.

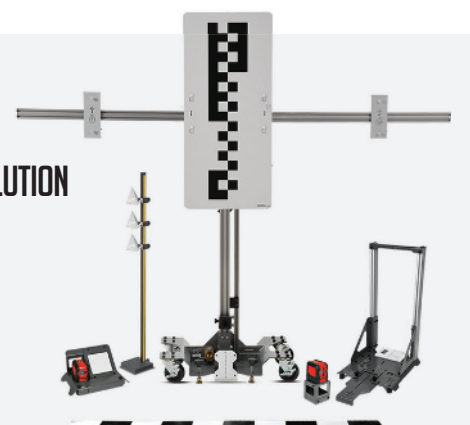

HOF-EESE900DXC

PRO-CUT BRAKE SOLUTIONS

X15™

ON-CAR BRAKE LATHE
X15 6 ADAPTER OCL PACKAGE
PCT PCX156ADP

\$17,478

FREE
1 TON
WHEEL ADAPTER
A \$450 VALUE



B17™

BENCH LATHE PACKAGE
PCT PCB17

\$15,125



MULE BY PRO-CUT

TIRE MULE
PCT 505100

\$1,506



coats Your full shop provider

Lifts Aligners Wheel Balancers Tire Changers Service Diagnostic Vehicle Inspection

FACTORY DIRECT

Scan Here for more info and to shop online
<https://www.napaonline.com/brand/coats>



Pro Series

NEW

E900 DIAGNOSTIC WHEEL BALANCER

The Coats ProBalance™ E900 is a high performing direct drive wheel balancer with new diagnostic ProMatch Technology. It's up to 10x faster than non-direct drive balancers, and the only premium wheel balancer on the market today with a 10-year warranty on the motor.

IT'S YOUR MODERN WORKHORSE

\$15,499 ^{\$340⁷⁹} For ⁶⁰ mos.

E900 Models

220V, 1Ph	CTC PROE900DA
220V, 3Ph	CTC PROE900DB

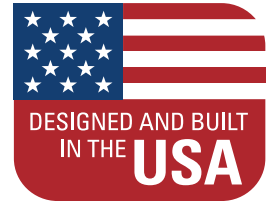

Advanced Technology With Diagnostics

In combination with direct drive technology, **ProMatch Technology** and a diagnostic roller are used to measure and address vibrations from wheel assembly shape without having to take it out on the road to test. ProMatch guides techs through a simple process to identify and reduce correctable runout. The result is a smoother ride and fewer customer returns for rework.

Hundreds of hours of tech feedback led us to the E900 touchscreen interface that's designed for comfort and maximum productivity. It streamlines data collection, reducing manual input needed before the first spin

- ProMatch Technology Runout Diagnostics
- ProBalance Technology®
- Updated touchscreen interface
- Speed Thread Pedal
- Hood Damper and 3D Data Entry
- Double sided collets included

Starting at \$2,063 Auto-Down Wheel Lift

A convenient, auto-retracting wheel lift to easily and safely mount heavy wheel assemblies



For 1600, E900 models	CTC 525AUTO16	\$2,063	^{\$113²²} For ²⁴ mos.
For 1400, 1500 models	CTC 525AUTO1415	\$2,309	^{\$126⁷³} For ²⁴ mos.



DIRECT DRIVE WHEEL BALANCERS

Coats direct drive technology delivers superior balancing results without frequent calibrations required by other systems. We integrate a robust motor and spindle into a single, factory pre-balanced assembly.

1600



\$11,249 ^{\$247³⁴} For ⁶⁰ mos.

220V, 1Ph	CTC 16003DA
220V, 3Ph	CTC 16003DB

- ProBalance Technology® - fix dynamic and residual static imbalance
- Enhanced Laser Guided Operation®
- Stop, Lock, & Index
- Touchscreen Interface
- Speed Thread™ Pedal
- Languages: English, Spanish, French
- Double Sided Collets Included

1500



\$9,999 ^{\$243¹⁰} For ⁶⁰ mos.

220V, 1Ph	CTC 15003DA
220V, 3Ph	CTC 15003DB

- Laser-Guided Operation – 5 O'Clock Tape Application – 12 O'Clock Clip Application
- Automatic 3-D Data Entry
- Stop and Lock Inverter Technology
- Double-Sided Collets Included

1300



\$6,699 ^{\$162⁸⁷} For ⁶⁰ mos.

220V, 1Ph	CTC 13002DA
220V, 3Ph	CTC 13002DB

- Static-On-Screen® Display Identifies Any Excess Residual Static Imbalance
- Automatic 2-D Data Entry on Wheel Diameter and Offset Measurement

HD-6450 Balancer Kit



\$20,999 ^{\$461⁷²} For ⁶⁰ mos.

1Ph	CTC 64503DLEA
3Ph	CTC 64503DLEB

The Coats 6450 is built for high-volume heavy duty wheel balancing and includes our 575 wheel lift, cones, and the Coats Heavy Duty Truck Kit.

RC WHEEL BALANCERS

NEW

The RC Series Balancers are compact wheel balancers for general repair shops with tight space requirements or that need extra capacity for busy seasons.

RC Balancers are a gateway to Coats and expanding your tire services without changing layout and site requirements.

RC550



\$6,150

^{\$149⁵²} For ⁶⁰ mos.
CTC RC550

RC450



\$4,949

^{\$136⁶⁶} For ⁶⁰ mos.
CTC RC450



coats Your full shop provider

Lifts Aligners Wheel Balancers Tire Changers Service Diagnostic Vehicle Inspection

FACTORY DIRECT

Scan Here for more info and to shop online
<https://www.napaonline.com/brand/coats>



MAXX TIRE CHANGERS

Maxx Series



\$15,499 \$340⁷⁹ For 60 mos.

Starting at **\$10,999**

Starting at **\$9,749**

\$7,449 \$181¹¹ For 60 mos.

220v	CTC MAXX90220	\$15,499
Air	CTC MAXX90A	\$15,499

220v	CTC MAXX80220	\$10,999	\$241 ⁸⁴ For 60 mos.
110v	CTC MAXX80	\$10,999	\$241 ⁸⁴ For 60 mos.
Air	CTC MAXX80A	\$10,999	\$241 ⁸⁴ For 60 mos.

Air	CTC MAXX70A	\$9,749	\$237 ⁰² For 60 mos.
220v	CTC MAXX70220	\$9,749	\$237 ⁰² For 60 mos.
110v	CTC MAXX70	\$9,749	\$237 ⁰² For 60 mos.

110v	CTC MAXX50	\$7,449
Air	CTC MAXX50A	\$7,449

- Leverless Duckhead bead lifter, RoboRoller, Robo-Arm
- Complete accessory package with 30" extended clamps
- Hand/Foot controlled bead loosener

- RoboRoller and Robo-Arm
- Hand/Foot controlled bead loosener
- Robust accessory package

- Patented Robo-Arm helper device

- Dual Nozzle Bead Sealer
- Change up to 16" wide and 50" diameter tires
- Clamp 6"-24" rims out of the box

Center Clamp Changers

Fast, robust, and helps prevent metal to metal contact with customer wheels.



\$13,499

\$296⁸¹ For 60 mos.
CTC 80CEH220, CTC 80CAH3

\$16,950

\$372⁶⁹ For 60 mos.
CTC 90CEH220, CTC 90CAH3

RC Tire Changers

Small footprint, rim clamp changers, perfect for independent repair shops



\$6,150

\$149⁵² For 60 mos.
CTC RC45A, CTC RC45E

\$8,649

\$210²⁸ For 60 mos.
CTC RC55A, CTC RC55E

Tiltback Changers

Change a wide variety of rims, including low profile, steel, alloy, and high performance wheels.



\$19,573

\$430³⁶ For 60 mos.
CTC APS3000

\$22,659

\$498²² For 60 mos.
CTC APX90E, CTC APX90A

\$13,889

\$305³⁹ For 60 mos.
CTC 9028

Heavy Duty Tire Changers



\$22,500 CHD 6330

\$494⁷² For 60 mos.

CTC CHD6330, CTC CHD63301PH

\$28,500 CHD 9041

\$626⁶⁵ For 60 mos.

CTC CHD9041

\$39,999 CHD 9551

\$879⁴⁸ For 60 mos.

CTC CHD9551

Alignment 4-Post Lift Kits

- Two Heavy-Duty Rolling Jacks
- Two Stainless Steel Turnplates
- Two Roll Back Bars
- Air Kit
- 26" wide double walled non-flex runways.
- Double Baked Corrosion Resistant Powder Coat
- U.S. Made Bucher Power Unit.



CTC 8K4P15SKITP

\$38,999

\$857⁴⁹ For 60 mos.

15K Standard Open Front
CTC 8K4P15SKITP

\$40,099

\$881⁶⁸ For 60 mos.

15K Extended Open Front
CTC 8K4P15XKITP

\$39,999

\$879⁴⁸ For 60 mos.

19K Standard Closed Front
CTC 8K4T419CSAR1

\$41,999

\$923⁴⁶ For 60 mos.

19K Extended Closed Front
CTC 8K4T419CXAR1

Alignment Scissor Lift Kits

- Two Heavy-Duty Rolling Jacks and air kit
- Set of Stainless Steel Turnplates & Roll Back Bars.
- Stainless Steel Electric Transducers for precise leveling and more precise alignments
- Non flex runways
- Double Baked Corrosion Resistant Powder Coat



CTC 8KSC14KITP

\$41,999

\$923⁴⁶ For 60 mos.

CTC 8KSC12KITP - 12K

\$44,099

\$969⁶³ For 60 mos.

CTC 8KSC14KITP - 14K

\$46,199

\$1,015⁸⁰ For 60 mos.

CTC 8KSC16KITP - 16K

2-Post Lifts

10K Capacity

\$7,999 \$194⁴⁸ For 60 mos.

CTC 4TV21NSR1 - asymmetric Red
CTC 4TV21NSB1 - asymmetric Blue

12K Capacity

\$10,749 \$236³⁴ For 60 mos.

CTC 4T212SSR1 - symmetric Red
CTC 4T212SSB1 - symmetric Blue



CTC 4TV21NSR1

16K and 20K Heavy Duty

\$21,599 \$474⁹¹ For 60 mos.

CTC 4T216SSR1 - 16K Red
CTC 4T216SSB1 - 16K Blue

\$26,999 \$593⁶⁴ For 60 mos.

CTC 4T220SSR1 - 20K Red
CTC 4T220SSB1 - 20K Blue

Pro Series



Inspection Lane

Our inspection lane includes the hardware and software to diagnose wheel alignment, tread depth safety and capture a 360-degree view of the vehicle's body condition – all in three seconds. Complete inspections as vehicles roll into a service lane and triple the size of your alignment service business.



PLUS Alignment Check Towers

\$49,999 \$1,099³⁶ For 60 mos.

CTC FLPLUS



BODYGUARD

\$12,499

\$274⁸² For 60 mos.

CTC 5200021

Tread Depth Scanner

\$27,999

\$615⁶³ For 60 mos.

CTC ETOC, CTC ETFC

Pro Series

3D Wheel Aligners

Coats aligners pair with all properly installed alignment lifts to diagnose and detail necessary corrections and are designed for ease, so shops power through repairs and services.

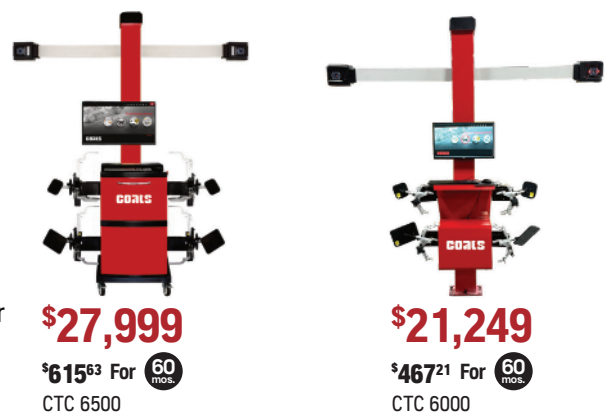

\$27,999

\$615⁶³ For 60 mos.

CTC 6500

\$21,249

\$467²¹ For 60 mos.

CTC 6000

FACTORY DIRECT



ROTARY SOLUTIONS
SERVING THE SHOP SINCE 1925

ROTARY

BY ROTARY SOLUTIONS



BY ROTARY SOLUTIONS

VEHICLE SERVICE LIFTS / A/C MACHINES

ROTARY 2-POST LIFTS



SPOA10-AV
ALL VEHICLE ASYMMETRIC LIFT
10,000 LBS. CAPACITY
The lift with AV Arms™ to service them all
RTY SPOA10N20MOK / BLACK
RTY SPOA10N20MOR / RED
RTY SPOA10N20MOB / BLUE
\$8,299

SPO12-AV
SYMMETRIC LIFT
12,000 LBS. CAPACITY
3 stage arms for greater reach
Thread up truck adapters with stackable 3-1/2" and 5" extensions
RTY SPO12N10T5BK / BLACK
RTY SPO12N10T5RD / RED
RTY SPO12N10T5BL / BLUE
\$11,899



SPOA10
ASYMMETRIC LIFT
10,000 LBS. CAPACITY
Versatile 2 stage arms with flip-up adapters
RTY SPOA10N1500R / RED
RTY SPOA10N1500B / BLUE
\$7,239

SPO16-AV
SYMMETRIC LIFT
16,000 LBS. CAPACITY
The lift with AV Arms™ to service them all
RTY SPO16N20A0BK / BLACK
RTY SPO16N20A0RD / RED
RTY SPO16N20A0BL / BLUE
\$27,209



ROTARY FLEX MAX

WIRELESS REMOTE-CONTROLLED MOBILE COLUMN LIFTS
• Battery Powered - No Power Cords • Spring Loaded Steering / Braking System
• Adjustable Forks • Lock Light, Digital Height & Weight Gauge



MCHM14
14K COLUMN CAPACITY
4 COLUMN SET RTY MCHM414
\$50,299



MCHM19
19K COLUMN CAPACITY
4 COLUMN SET RTY MCHM419
\$57,099

ROTARY ALIGNMENT LIFTS



XA14
OPEN THRU SCISSOR LIFT
14,000 LBS. CAPACITY
184" Max Wheelbase
RTY XA14N101BK / BLACK
\$40,009
201" Max Wheelbase
RTY XA14N102RD / RED
RTY XA14N102BL / BLUE
\$44,109



ARO16
OPEN FRONT LIFT
16,000 LBS. CAPACITY
194" Max Wheelbase
RTY ARO16N001BK / BLACK
RTY ARO16N001RD / RED
RTY ARO16N001BL / BLUE
\$38,799
217" Max Wheelbase
RTY ARO16N002RD / RED
RTY ARO16N002BL / BLUE
\$40,499



ARO22
OPEN FRONT LIFT
22,000 LBS. CAPACITY
194" Max Wheelbase
RTY ARO22N100RD / RED
RTY ARO22N100BL / BLUE
\$49,359
230" Max Wheelbase
RTY ARO22N101RD / RED
RTY ARO22N101BL / BLUE
\$51,899



2-POST LIFTS



I10 10K CAPACITY
FWD I10N500MBK / BLACK
\$5,999 \$145⁸⁵ For 60 mos.



F10 10K CAPACITY
FWD F10N500MBK / BLACK
\$5,499 \$133⁷⁰ For 60 mos.



F12 12K CAPACITY
FWD F12N300BK / BLACK
178" Lift Height
FWD F12N301BK / BLACK
166" Lift Height
FWD F12N302BK
154" Lift Height
FWD F12N303BK
143" Lift Height
\$9,599 \$233³⁸ For 60 mos.



I12 12K CAPACITY
FWD I12N300BK / BLACK
13' 10" Lift Height
FWD I12N301BK / BLACK
14' 10" Lift Height
FWD I12N302BK / BLACK
12' 10" Lift Height
FWD I12N303BK / BLACK
11' 11" Lift Height
\$10,399 \$228⁶⁵ For 60 mos.

4-POST LIFTS



ALIGNMENT LIFTS
CRA14 14K CAPACITY
FWD CRA14N201YBK / BLACK
182-1/2" Max Wheelbase
\$20,919 \$459⁹⁶ For 60 mos.
FWD CRA14N202YBK / BLACK
215" Max Wheelbase
\$22,199 \$488¹⁰ For 60 mos.



CR14 14K CAPACITY
FWD CR14N201YBK / BLACK
182-1/2" Max Wheelbase
\$8,299 \$201⁷⁷ For 60 mos.
FWD CR14N202YBK / BLACK
215" Max Wheelbase
\$10,599 \$233⁰⁵ For 60 mos.



EFP8 8K CAPACITY
FWD EFP8P000MBK / BLACK
175-1/2" Length
\$5,799
\$140⁹⁹ For 60 mos.



EFP9 9K CAPACITY
FWD EFP9P000MBK / BLACK
193-1/5" Length
\$6,499 \$158⁰¹ For 60 mos.

ROTARY A/C SERVICE



R3AC50A
R134a GAS
• 50lb. refrigerant tank
• Automatic or manual use
• Wi-Fi enabled with vehicle data
RTY R3AC50A
\$5,359



R3AC60YF
R1234yf GAS
• 22 lb. refrigerant tank
• Wi-Fi with 2 years vehicle data
• Team Viewer Support
RTY R3AC60YF
\$7,889



R3AC80AYF
DUAL GAS CART
• Service R134a & R1234yf gases
• Two tanks and circuits
• Auto clean on gas change
RTY R3AC80AYF
\$11,999



DP15
15K CAPACITY
FWD DP15N001BK / BLACK
175" Lift Height
FWD DP15N000BK / BLACK
in 154-3/4"
\$16,599 \$364⁹⁷ For 60 mos.
FWD DP15N002BK / BLACK
199" Lift Height
\$17,899 \$393³⁶ For 60 mos.



DP18PRO
18K CAPACITY
FWD DP18PN001BK / BLACK
175" Lift Height
FWD DP18PN000BK / BLACK
154-3/4" Lift Height
\$20,999 \$461⁷² For 60 mos.
FWD DP18PN002BK / BLACK
199" Lift Height
\$21,999 \$483⁷⁰ For 60 mos.





ROTARY

BY ROTARY SOLUTIONS

FACTORY DIRECT



SCAN CODE FOR MORE PRODUCT INFO AND THE HOTTEST DEALS ON THE ENTIRE ROTARY AND FORWARD PRODUCT CATALOG

WHEEL SERVICE EQUIPMENT

TIRE CHANGERS

R1250 LEVERLESS PRO TIRE CHANGER

RTY RWC1250

FEATURES:

- Leverless mounting and demounting
- Laser positioning dual bead breaking rollers
- Memory function for positioning mount/demount tool
- Three-position pedestal
- Front-loading pneumatic wheel lift
- Integrated helper arm
- Pedal-operated inflation with gauge and balancing valve

SPECIFICATIONS

- Max tire width: 19"
- Max wheel diameter: 30"
- Max tire diameter: 47"
- 220v drive motor with variable speed control

\$25,999



R247D CLIB SWINGARM TIRE CHANGER

RTY RWC247DCLIB

FEATURES

- Quick locking wheel centering adapter
- 10" to 30" rim clamping
- Integrated helper arm and lower bead lifting roller
- Hand controlled bead breaker works on low-profile, large steel or alloy rims
- Pneumatic wheel lift

SPECIFICATIONS

- Max Tire Width: 15"
- Max Wheel Diameter: 30"
- Max Tire Diameter: 45"
- 220v drive motor with variable speed control

\$11,999



R200 SWINGARM TIRE CHANGER

RTY RWC200D
220V variable speed drive

RTY RWC200R
110V single speed drive

FEATURES:

- 220v variable speed drive supplies torque & regulates speed to reduce tire stress
- Available 110v high torque single speed drive model
- Hand controlled bead breaker
- Column-mounted storage case
- Pedal operated table inflation
- Patented top-inflation bead seater
- Pneumatic top bead tool and lifting roller

SPECIFICATIONS

- Max tire width: 16"
- Max wheel diameter: 26"
- Max tire diameter: 52"
- Voltage required: 110 volt

\$8,999



R146RP SWINGARM PRO TIRE CHANGER

RTY R146RP

FEATURES:

- Hand controlled side bead breaker
- Integrated helper arm and lower bead lifting roller
- 110-volt drive motor provides torque

SPECIFICATIONS

- Max tire width: 15"
- Max wheel diameter: 26"
- Max tire diameter: 46"
- Voltage required: 110 volt

\$7,999



R144i SWINGARM TIRE CHANGER

RTY R144i

FEATURES:

- Versatile self-centering rim clamps
- Hand controlled bead breaker
- Space-saving encapsulated air tank
- Convenient storage cabinet
- 110-volt drive motor

SPECIFICATIONS

- Max tire width: 15"
- Max wheel diameter: 26"
- Max tire diameter: 46"
- Voltage required: 110 volt

\$6,199



WHEEL BALANCERS

R160 3D AUTO

RTY RWB160

FEATURES:

- Simple visual display
- 22" monitor
- Automatic program
- Double LED lights
- Internal data gauge
- Space saving footprint

SPECIFICATIONS

- Max tire width: 22"
- Max wheel diameter: 30"
- Max tire diameter: 44"
- Voltage required: 110 volt

\$8,999



R150 2D AUTO

RTY RWB150

FEATURES:

- Passenger, Light Truck adapters are standard
- 9-piece collet set available
- Large display for easy operation
- Laser line positioning guide
- Features for car, light trucks, and motorcycle wheels

SPECIFICATIONS

- Max tire width: 22"
- Max wheel diameter: 26"
- Max tire diameter: 44"
- Voltage required: 110 volt

\$6,499



WHEEL ALIGNERS

R1090 MOBILE TABLET

RTY RWA1090

TOWER FREE TABLET ALIGNER

FEATURES:

- No minimum distance in front of the lift
- Can be used on multiple lifts
- Fixed cameras and exclusive 3D targets
- Self-centering three-point clamps
- Automatic lift level compensation
- 10" Android tablet
- Bluetooth® communication
- WiFi capable
- PC with keyboard, mouse, and printer
- Voltage required: 110 volt

\$26,999



R1075 TOWER

RTY R1075
3D WHEEL ALIGNER

FEATURES:

- Mobile cabinet with large 27" monitor
- Auto adjusting HD cameras
- On Rack Test Drive for a straight steering wheel
- Wi-Fi capable
- PC with keyboard, mouse and printer
- Premium 4-point clamps
- Voltage required: 110 volt

\$19,999



R1065

RTY RWA1065
MOBILE ALIGNMENT SYSTEM WITH TABLET

FEATURES:

- Tower free system
- Bluetooth® transmission
- 10" Android tablet
- WiFi communication
- Quick charge supports
- 8-CCD sensor
- Wheeled storage cart
- Voltage required: 110 volt

\$11,999



COMMERCIAL TRUCK EQUIPMENT

R501PLUS SPEEDCHANGER TIRE CHANGER

RTY R501PLUS

FEATURES:

- Dismounts and mounts truck tires in 30 seconds
- Adjustable arm position
- Four rollers positioned on both sides of the wheel in diametrically opposite positions
- Ergonomic (back saving) design
- Includes clamp protectors for wheels

SPECIFICATIONS

- Max tire width: 21"
- Max wheel diameter: 27"
- Max tire diameter: 52"

\$26,739



R560 MOBILE HD TIRE CHANGER

RTY RWC26HWSB

FEATURES:

- Hydraulic clamping and up/down movement
- Standard finger adapter for tube tires
- Includes clamp protectors for aluminum wheels

SPECIFICATIONS

- Max tire width: 37.4"
- Max wheel diameter: 27"
- Max tire diameter: 51"

\$12,559



R544P TRUCK 3D WHEEL BALANCER

RTY RWB280PLUSB

FEATURES:

- Microprocessor provides self-calibration and self-diagnostics
- Single spin provides all values
- Programs for static, dynamic, ALU wheels
- Air lift with capacity of 441 lbs.
- Auto stop on top / auto indexing
- Passenger tire and light truck cone kits

SPECIFICATIONS

- Max tire width: 22"
- Max wheel diameter: 30"
- Max tire diameter: 51"
- Voltage required: 110 volt

\$13,999



Rotary's line of premium wheel service equipment is manufactured to the highest standards of quality and durability to help you perform the job right the first time, every time.

ROTARY carries an industry-leading 3 year parts and 1 year labor warranty. Plus, FREE set up, and on-site training on all wheel service equipment.



\$749⁰⁰ /each

Redline Detection Ready Smoke Machine

BK 950400

- Pinpoint Intake, Exhaust and Other EVAP Leaks in Minutes
- This Diagnostic Leak Machine Can Pinpoint Leaks Down to 0.010"



\$1,189 /each

Redline Detection Smoke Pro Total Tech Smoke Machine

BK 950050

- Uses Pressure, Vacuum and Visible Vapor to Quickly Diagnose Trouble Codes to Pinpoint Evap Leaks, Cooling System Leaks, Intake and Exhaust Leaks, Wind, Water and Oil Leaks
- This Diagnostic Leak Machine Can Pinpoint Leaks Down to 0.010"



\$1,399 /each

Redline Detection Smoke Pro Air Smoke Machine

BK 950075

- Features an Onboard Micro Air Compressor for Total Portability and Includes All Needed Accessories
- Ideal for Performing Diagnostics on the EVAP Systems of Naturally Aspirated Vehicles
- Pinpoint Leaks Down to 0.010"



Special Order

Shop-Ready System to Cut, Program & Sell More Keys

Complete Key Making System

Identify · Cut · Program

Visit www.nitrouskeys.com

Item# XTL 20402085

\$8,658
~~\$9,620~~

\$210⁵⁰ For 60 mos.



AutoProPAD CORE Key Programmer



\$954
~~\$1,060~~

Item# XTL 20426809

AutoProPAD G3 EVOLUTION Key Programmer



\$2,502
~~\$2,780~~

\$137³² For 24 mos.

Item# XTL 20426811

Triton Plus Key Cutter



\$4,908.60
~~\$5,454~~

\$135⁵⁴ For 60 mos.

Item# XTL 20201002

CRC SmartWasher



\$2349

Multi-Layer OzyMat®

SW FL4



- SW 1751154 MicroPRO Pack® \$28.49
- SW 1750987 BT5 Ready To Use Degreasing Solution \$49.49
- SW 1000872 CRC SmartWasher® BenchtopPRO® \$489.99



\$104⁹⁹

OzyJuice® Aircraft & Weapons

SW SW8



\$104⁹⁹

OzyJuice® Truck Grade

SW SW3



\$104⁹⁹

OzyJuice® Heavy Duty Grade

SW SW4



\$104⁹⁹

OzyJuice® High Temp

SW SW7



\$149⁹⁹

OzyJuice® High Performance

SW 1751304



- SW SW323 Mobile Parts/Brake SmartWasher® \$2,349
- SW SW423 Mobile Parts/Brake SmartWasher® \$2,349
- SW SW823 Mobile Parts/Brake SmartWasher® \$2,349
- SW SW723 Mobile Parts/Brake SmartWasher® \$2,349
- SW 1751310 Mobile Parts/Brake SmartWasher® \$2,549
- SW 1751314 Mobile Heavyweight SmartWasher® \$3,449
- SW SW837 Mobile Heavyweight SmartWasher® \$3,199
- SW SW337 Mobile Heavyweight SmartWasher® \$3,199
- SW SW437 Mobile Heavyweight SmartWasher® \$3,199
- SW SW737 Mobile Heavyweight SmartWasher® \$3,199





FACTORY DIRECT

Reciprocating Air Compressor

Ingersoll Rand's 2-Stage, 175PSI Air Compressor is designed for use in commercial, automotive and light industrial applications. The pump in the 2-stage air compressor is made from cast-iron for durability and is oil-lubricated. Our base Value Package offers an economical choice for commercial, automotive and light industrial applications.

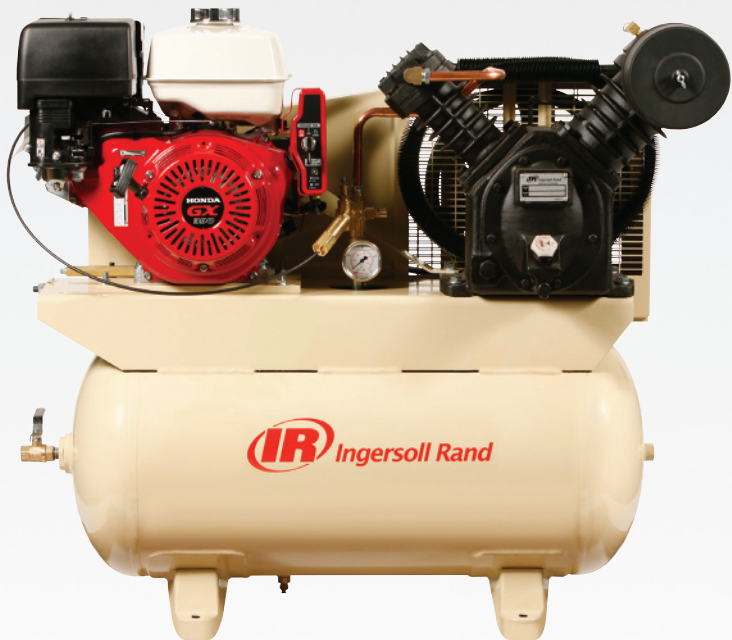

COMPRESSOR START-UP KITS SOLD SEPARATELY

45466067: sold with **47853635006R**

45465408, 45465226, 45465523: sold with **47853635004R**

45465929, 45465937: sold with **47853635005R**

IR 45465408	Value Package 230/1/60 7.5HP 80G Vertical 24.3 CFM	\$112.16 For ⁴⁸ mos	\$3,499.99
IR 45466067	13HP HONDA 30G Truck Mount Gas Compressor 24.3 CFM	\$121.22 For ⁶⁰ mos	\$4,389.99
IR 45465226	Premium 230/1/60 5HP 80G Vertical 17.2 CFM	\$118.74 For ⁶⁰ mos	\$4,299.99

IR 45465523	Premium 230/1/60 7.5HP 80G Vertical 24.3 CFM	\$122.33 For ⁶⁰ mos	\$4,429.99
IR 45465929	Premium 230/3 Phase 10HP Horizontal 35.6 CFM	\$179.67 For ⁶⁰ mos	\$7,389.99
IR 45465937	Premium 460/3 Phase 10HP Horizontal 35.6 CFM	\$179.67 For ⁶⁰ mos	\$7,389.99



FACTORY DIRECT

TWO-STAGE PREMIER SIMPLEX AIR COMPRESSORS READY TO RUN, NO START-UP KIT REQUIRED

Model	Gallon	HP	ACFM @ 100	Max PSI	Volts/Phase	Price
NAC ABC52180VP	80	5	18	175	230/1	\$2,955 ^{*115⁹² For 36 mos}
NAC ABC72180VP	80	7.5	23	175	230/1	\$3,125 ^{*100¹⁴ For 48 mos}
NAC ABC72380VP	80	7.5	23	175	230/3	\$3,125 ^{*100¹⁴ For 48 mos}
NAC ABC72180V2P	80	7.5	27	175	230/1	\$3,815 ^{*105³⁴ For 60 mos}
NAC ABC72380V2P	80	7.5	27	175	230/3	\$3,815 ^{*105³⁴ For 60 mos}
NAC ABC102312HP	120	10	35	175	230/3	\$3,999 ^{*110⁴³ For 60 mos}
NAC ABC102312VP	120	10	35	175	230/3	\$4,460 ^{*123¹⁵ For 60 mos}

PREMIER UNITS FEATURE:

Heavy-duty cast iron pumps, Low RPM pumps, Baldor electric motors, Heavy-duty sheet metal belt guards, Mounted and wired magnetic starters, Low oil level switch, Cast iron aftercooler, Automatic tank drain; Anti-vibration pads



AS LOW AS **\$6,295**



ROTARY SCREW AIR COMPRESSORS W/DRYER

- Fully integrated aluminum block
- Limited air losses due to compact size
 - Energy efficient motor
 - Intuitive digital controller
 - Simple, quick, and easy maintenance

AS LOW AS **\$899**



COOL REFRIGERATION AIR DRYERS

- The COOL range offers reliable components in a simple vertical lay-out
- Simple to install and easy to operate
 - Easy access for quick servicing resulting in low maintenance costs
 - Flexible transportation
 - Stable dew point
- Footprint only 1.4 Ft.**

SIMPLEX AIR COMPRESSORS READY TO RUN, NO START-UP KIT REQUIRED

Model	Gallon	HP	ACFM @ 100	Max PSI	Volts/Phase	Price
Single Stage						
NAC AB224VP	24	2	7.5	135	115/1	\$915
NAC AB32160V1	60	3	12.5	135	230/1	\$1,240 ^{*124⁸⁸ For 12 mos}
Two-Stage						
NAC AB52160V4	60	5	14.6	175	230/1	\$1,615 ^{*162⁶⁴ For 12 mos}
NAC AB52180V4NS	80	5	14.6	175	230/1	\$1,990 ^{*109²² For 24 mos}
NAC ABC52180V	80	5	18	175	230/1	\$2,839
NAC ABC52380V	80	5	18	175	230/3	\$2,839
NAC ABC72180V	80	7.5	23	175	230/1	\$3,039
NAC ABC72180V2	80	7.5	27	175	230/1	\$3,649
NAC ABC72380V2	80	7.5	27	175	230/3	\$3,649



Pricing Valid as of 07/01/2026 and expires 09/30/2026 but is subject to change based on external factors. Any changes to pricing will be disclosed prior to purchase.



FACTORY DIRECT



QUIETEST COMPRESSOR ON THE MARKET

ALL SINGLE PHASE UNITS
SHIP NEXT BUSINESS DAY

Part No.	HP Spec	Tank Size	Pump Style	Price
FXZ FS05V08011	5 HP	80 GAL.	Pressure	\$4,599
FXZ FXS07V080V1	7.5 HP	80 GAL.	Pressure	\$5,529
FXZ FXS10V080V1	10 HP	80 GAL.	Pressure	\$6,199
FXZ FXS10V120V1	10 HP	120 GAL.	Pressure	\$6,499

QUIET TECHNOLOGY™

REDUCES HIGH FREQUENCY NOISE LEVELS

SILENCER

PATENTED NOISE SUPPRESSION

REDUCES LOW FREQUENCY NOISE LEVELS

WATER HOSE

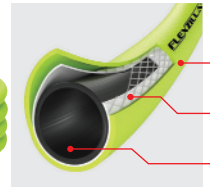

- PREMIUM MATERIALS & CONSTRUCTION**
- Durable outer cover resists abrasion and UV
 - Reinforced mid-layering provides extra strength
 - Inner tube completes the trifecta to deliver unmatched quality

Part No.	Description	Price
FXZ HFZG550YW	Flexzilla® Garden Hose, 5/8" x 50', 3/4" - 11 1/2 GHT Fittings	\$57.59
FXZ HFZG5100YW	Flexzilla® Garden Hose, 5/8" x 100', 3/4" - 11 1/2 GHT Fittings	\$91.79

AIR HOSE, REELS & ACCESSORIES



Part No.	Description	Price
FXZ HFZ3825YW2	Flexzilla® Air Hose, 3/8" x 25', 1/4" MNPT Fittings	\$36.89
FXZ HFZ1225YW3	Flexzilla® Air Hose, 1/2" x 25', 3/8" MNPT Fittings	\$39.59
FXZ HFZ3850YW2	Flexzilla® Air Hose, 3/8" x 50', 1/4" MNPT Fittings	\$46.79
FXZ AL2000FZ	Flexzilla® Chuck Inflator with 12' Hose	\$47.69
FXZ HFZ1250YW3	Flexzilla® Air Hose, 1/2" x 50', 3/8" MNPT Fittings	\$67.49
FXZ L8250FZ	Flexzilla® Enclosed Plastic Retractable Air Hose Reel, 3/8" x 50'	\$157.49
FXZ AL2025FZ2	Flexzilla® Combo Inflator Kit with Flexzilla Air Hose 3' and 15' Extensions	\$172.79
FXZ FZ8120603	Flexzilla® Pro Retractable Extension Cord Reel, 60', 12/3 AWG SJTOW	\$210.59
FXZ L8335FZ	Flexzilla® Pro Retractable Air Hose Reel with Levelwind™ Technology, 1/2" x 50'	\$329.39
FXZ L8611FZ	Flexzilla® Retractable Air Hose Reel, Open Face, Single Axle Arm, 3/8" x 50'	\$329.39
FXZ L8305FZ	Flexzilla® Pro Retractable Air Hose Reel with Levelwind™ Technology, 3/8" x 50'	\$334.79
FXZ L8306FZ	Flexzilla® Pro Retractable Air Hose Reel with Levelwind™ Technology, 3/8" x 75'	\$394.19

PORTABLE AIR COMPRESSORS

Part No.	Description	Price
FXZ CB20100F	Flexzilla® Portable Air Compressor, 2 HP, 10 Gallon	\$544.49
FXZ CB20200F	Flexzilla® Portable Air Compressor, 2 HP, 20 Gallon	\$652.49



REFRIGERATED AIR DRYERS

Part No.	Volt	CFM	HP Spec	Price
FXZ FDRCF1150030	115	30	5-7.5	\$3,229
FXZ FDRCF1150058	115	58	10	\$4,249



NEW BUSINESS, SHOP EXPANSIONS, AND CAPITAL EQUIPMENT PURCHASES?

LET US HELP

Finance your business growth through Commodore Financial



A DIVISION OF GREATAMERICA FINANCIAL SERVICES®

www.commodorefinancial.com



Scan to Learn More Or Apply Today





1-DIRECT NAPA TPMS SENSOR

MAXIMUM COVERAGE, LONG LIFE, BUILT TO GO THE DISTANCE

DUAL FREQUENCY SNAP-IN/CLAMP-IN TPMS SENSOR

The cutting-edge solution for precise tire monitoring. This advanced sensor combines two frequencies for unparalleled accuracy in tracking tire pressure and temperature.

- Programs any vehicle in seconds
- 99.5% vehicle coverage
- One sensor covers both frequencies (315 & 433 MHz)
- Dual valves - both rubber snap-in and metal clamp-in
- 3 year warranty



SM-1SC (1 PACK)
\$27.54



SM-4SC (4 PACK)
\$99.99



SM-20SC (20 PACK)
\$499



SM-120SC (120 PACK)
\$2,999



BUNDLE OFFERS

PURCHASE 20 1-DIRECT NAPA TPMS SENSORS, AND RECEIVE A FREE SM41TPMST TPMS TOOL KIT



\$549
PN: NTH SM4120LKTPTS

PURCHASE 40 1-DIRECT NAPA TPMS SENSORS, AND RECEIVE A FREE SM47TPMST TPMS TOOL KIT



\$849
PN: NTH SM4740PNTPM

PURCHASE 120 1-DIRECT NAPA TPMS SENSORS, AND RECEIVE A FREE SM57TPMST TPMS TOOL KIT



\$2,799 ^{\$109⁹⁰} For ³⁶ mos.
PN: NTH SM57120STPMS

BLUETOOTH TPMS SENSOR

The ultimate companion for safer and smarter driving. Easy to install on each tire, it wirelessly connects to the in-car Bluetooth system, providing real-time tire pressure and temperature data at your fingertips.

- Direct replacement for Tesla OE sensors
- Preprogrammed for Tesla Model 3, S, X, & Y
- Valve stem color options for alloy wheel finish
- 2 year warranty



\$74.99 SM-BLE

TPMS REPLACEMENT VALVE STEMS

RUBBER SNAP-IN

- 80 psi max cold inflation pressure
- Anti-spin design with max speed rating of 130 mph
- Constructed of high temperature nickel plated brass valve cores and ozone resistant EPDM rubber



METAL CLAMP-IN

- 130 psi max cold inflation pressure
- Max speed rating of 200 mph
- Constructed of light weight high-grade corrosion resistant anodized aluminum, nickel plated brass valve core, and EPDM ozone resistant rubber grommet



Pack Size	Parallel Key	Right Angle Key	Square Key	Parallel Key
2	SMTPM-15202 \$3.51	SMTPM-15204 \$3.99	SMTPM-1525 \$4.29	SMTPM-2012VK \$5.98
25	SMTPM-15202B \$1.23	SMTPM-15204B \$1.49	SMTPM-1525B \$1.69	SMTPM-2012VKB \$2.18
Pack Size	Parallel Key	Parallel Key	Rounded Bottom	Universal Kit
2	SMTPM-2012VBK \$5.98	SMTPM-2012VCK \$6.99	SMTPM-11 \$7.59	SMSMK-036A \$4.69
25	SMTPM-2012VBKB \$2.18	SMTPM-2012VCKB \$2.19	SMTPM-11B \$2.84	SMSMK-036AB \$1.99

TPMS TOOLS



BUILT-IN OBDII MODULE

TRIGGER 100% OF OE SENSORS

MANUAL & OBDII RELEARN PROCEDURES



\$549
SM41



\$559
SM47



\$1,149
SM57

Key Features	SM41	SM47	SM57
Programs NAPA brand TPMS	YES	YES	YES
Programs 20+ brands of aftermarket sensor brands	NO	YES	YES
100% coverage for Domestic, European, and Asian vehicles	YES	YES	YES
Comprehensive make, model, year relearn procedures	YES	YES	YES
Provides TPMS relearn procedures on-screen	YES	YES	YES
Ability to reset vehicles via both manual and OBDII relearn	YES	YES	YES
TPMS reset via OBDII on more than 90% of car models	YES	YES	YES
Supports Placard Adjustment	YES	YES	YES
5 Years of FREE updates	YES	YES	YES
2 Year Warranty	YES	YES	YES
Wi-Fi & real time updates, powered by Live Sensor™	YES	YES	YES
ECU unlocking for Toyota family of vehicles	YES	YES	YES
VIN scan barcode reading	NO	NO	YES
DOT Recording	NO	NO	YES
Touch-Screen Interface	NO	NO	YES
Make, Model, Year look-up via VIN scan	NO	NO	YES
Read/Clear TPMS DTC Codes	NO	NO	YES
Tire Tread Depth Functionality	NO	NO	YES
Key Specifications	SM41	SM47	SM57
Screen Size	2.8"	2.8"	4.3"
Weight in lbs.	1.0	1.0	2.0
Operating Temperature from -4 degrees F to 131 degrees F	YES	YES	YES

NAPA PREMIUM WHEEL WEIGHTS

BALANCED RIDE, PEAK PERFORMANCE, SAFE RIDE



\$1,999 ^{\$109⁷¹} For ²⁴ mos.
ZINC BUNDLE WHEEL WEIGHTS WITH FLOOR RACK
NTH SMESMH09

- Epoxy grey coating provides premium corrosion resistance
- Perfect blend of performance with contoured shape and affordability
- 1645 zinc clip-on weights
- 1556 steel adhesive tape segments
- Free premium standing wheel weight rack
- Includes 12 free NAPA TPMS Sensors



\$1,549 ^{\$156⁰⁰} For ¹² mos.
STEEL BUNDLE WHEEL WEIGHTS WITH FLOOR RACK
NTH SMESMH08

- Dacromet coating provides exceptional corrosion resistance
- Perfect blend of performance with contoured shape and affordability
- 1645 steel clip-on weights
- 1556 steel adhesive tape segments
- Free premium standing wheel weight rack
- Includes 12 free NAPA TPMS Sensors



\$499
WHEEL WEIGHT FLOOR RACK (RACK ONLY)
NTH SMESMH05

- Reinforced structure to ensure stability
- 80 color coded plastic removable bins
- Preprinted bin labels
- NAPA header card with style images



\$32.99
.25oz Adhesive Wheel Weights Box (Grey Epoxy) NTH 7525FE



\$39.99
.25oz Adhesive Wheel Weights Roll (Grey Epoxy) NTH 7525FER10



\$29.99
.50oz Adhesive Wheel Weights Box (Grey Epoxy) NTH 7550FE



\$39.99
.50oz Adhesive Wheel Weights Roll (Grey Epoxy) NTH 7550FER10



\$32.99
1.00oz Adhesive Wheel Weights Box (Grey Epoxy) NTH 75100FE



Apply for Financing Now



\$34.99
.25oz Adhesive Wheel Weights Box (Silver Dacromet) NTH 7325FE



\$44.99
.25oz Adhesive Wheel Weights Roll (Silver Dacromet) NTH 7325FER10



\$32.99
.25oz Adhesive Wheel Weights Box (Black Epoxy) NTH 7026FEB



\$39.99
.25oz Adhesive Wheel Weights Roll (Black Epoxy) NTH 7026FER10



\$29.99
.50oz Adhesive Wheel Weights Box (Black Epoxy) NTH 7027FEB



\$39.99
.50oz Adhesive Wheel Weights Roll (Black Epoxy) NTH 7027FER10

Forney®

WELDING AND METALWORKING

TO CLAIM YOUR GREENBACK® REBATE
 GO TO WWW.FORNEYIND.COM/PRODUCT-REBATES OR SCAN THE QR CODE
 Receive a rebate when you purchase a qualifying Forney® welder from NAPA from July 1 - September 30, 2026



FNY 363 FORNEY® 140 MIGx

- MIG (GMAW) & FLUX-CORE (FCAW)
- DIGITAL DISPLAY & TRUSET PROCESSES
- 1/4 IN WELD IN SINGLE PASS
- 30% @ 90A DUTY CYCLE



\$429.99

NEW MACHINES PROVEN QUALITY

SHAPE WHAT'S NEXT



ALL NEW MACHINES COME WITH A 3 YEAR WARRANTY AND ARE CSA CERTIFIED



FNY 305 FORNEY® 125 FCx

- FLUX-CORE (FCAW)
- DIGITAL DISPLAY & TRUSET PROCESS
- 1/4 IN WELD IN SINGLE PASS
- 30% @ 90A DUTY CYCLE

\$274.99



FNY 357 TRUCUT PLASMA CUTTER

- 120V INPUT POWER
- CLEAN CUT 1/4 IN, SEVER CUT 3/8 IN
- PILOT ARC AND DRAG TORCH FOR STEADY, PRECISE CUTS
- DIGITAL DISPLAY IS BRIGHT AND EASY TO READ

\$469.99



FNY 319 FORNEY® 270 MIG

- 230V INPUT POWER & 270A
- MIG (GMAW) & FLUX-CORE (FCAW)
- ACCEPTS UP TO .045 IN WIRE
- MULTIPLE TRIGGER MODES FOR SPOT WELDING, 2T & 4T
- 15 FT MIG GUN, POWER CORD, AND GROUND CLAMP; FLOWMETER & HOSE INCLUDED

\$3,199

\$102⁵² For **48** mos



FNY 300 FORNEY® 190 AC/DC MP

- 120V/240V INPUT POWER & 110/190 AMPS OF WELDING POWER
- AC TIG (AC GTAW), DC TIG (DC GTAW), TRUSET MIG (SYNERGIC MIG), MIG (GMAW), FLUX-CORE (FCAW), STICK (SMAW)
- PULSE TIG, AC +/- BALANCE, AC HZ FREQUENCY TO CONTROL ARC AND TRAVEL SPEEDS
- SPOOL GUN CAPABLE – FNY 85650

\$1,849

\$101⁴⁸ For **24** mos



FNY 445 FORNEY® 45 P PLASMA CUTTER

- 120V/240V INPUT POWER & 45A
- CUT RATING - MILD STEEL: 7/8 IN @ 10 IN/MIN
- SEVER – MILD STEEL 1-1/8 IN @ 5 IN/MIN
- TORCH LENGTH: 25 FT, POWER CORD AND GROUND CLAMP 15 FT
- SPOOL GUN CAPABLE – FNY 85650

\$2,199

\$120⁶⁹ For **24** mos



FORNEY PRO® SINCH SERIES™ METALWORKING GLOVE

ITEM#S: 55151 (M), 55152 (L), 55153 (XL), 55154 (2XL)

- KEVLAR® STITCHING
- PREMIUM GOATSKIN LEATHER
- 360° KEVLAR CUT A5 (ANSI) LINING

\$44.99



FORNEY® SINCH SERIES™ WELDING GLOVE

ITEM#S: 55111 (M), 55112 (L), 55113 (XL), 55114 (2XL)

- KEVLAR® STITCHING
- SPLIT COWHIDE LEATHER
- EXTENDED GAUNTLET CUFFS

\$19.99



FORNEY PRO® CUT A5 MIG/TIG WELDING GLOVE

ITEM#S: 55131 (M), 55132 (L), 55133 (XL), 55134 (2XL)

- KEVLAR® STITCHING
- PREMIUM GOATSKIN LEATHER
- 360° KEVLAR CUT A5 (ANSI) LINING

\$39.99



START WHAT DOESN'T WANT TO BE STARTED



ALL LITHIUM JUMP STARTERS FEATURE:

- Backfeed Protection
- Over-Voltage Protection
- Overheat Protection
- Reverse Polarity
- LED State-of-Charge
- Conforms to UL2743
- Automatic Charging
- 1 Year Warranty



**SOR JNC345
LITHIUM 12 VOLT
3000 AMP
JUMP STARTER**

\$275⁰⁰

550 START ASSIST AMPS

STARTS MOST 10.0L GAS / 10.0L DIESEL



- Effective to -23°F • 40" Cable Length • High Tension Clamps
- #6 AWG Cables • 2 USB Ports • DC Output • MaxAccess Clamps



**SOR JNC305 LITHIUM
12V 1000 AMP JUMP STARTER**

\$109⁰⁰

300 START ASSIST AMPS

STARTS MOST 6.0L GAS / 3.0L DIESEL

- Effective to 0°F
- 21" Cable Length
- #6 AWG Cables
- USB Port
- MaxAccess Clamps
- USB-C Charging



**SOR JNC325 LITHIUM
12V 2000 AMP JUMP STARTER**

\$199⁰⁰

450 START ASSIST AMPS

STARTS MOST 8.0L GAS / 6.0L DIESEL

- Effective to -10°F
- 24" Cable Length
- #6 AWG Cables
- 2 USB Ports
- MaxAccess Clamps
- USB-C Charging



**SOR JNC660 12 VOLT
1700 AMP JUMP STARTER**

\$185⁰⁰



**1700 PEAK AMPS
425 CRANKING AMPS**

- 46" Cable Length • #2 AWG Cables
- Industrial Clamps • 12VDC Outlet • Built-in Charger



**SOR LNC1541
LED COB 500 LUMEN
WORK LIGHT**

\$57⁹⁹

- Advanced COB Technology
- 60lm SMD Focus Beam Setting
- Up to 4 hour Run time on High
- IP54 Dust/Water Ingress Protection



**LIGHT
n Carry**



MANTIS

**SOR LNCMINI 110 MAX LUMEN
COB LED RECHARGEABLE WORK LIGHT**

\$24⁹⁹



**SOR LNC312 120 MAX LUMEN
LED RECHARGEABLE PEN LIGHT**

\$29⁹⁹



**SOR LNC330 400 MAX LUMEN LED
RECHARGEABLE TORCH LIGHT**

\$47⁹⁹



**SOR LNC375 750 MAX LUMEN LED
RECHARGEABLE TORCH LIGHT**

\$69⁹⁹



**JUMP STARTERS
THE ORIGINAL AND STILL THE BEST**



**SOR ES2500
12V JUMP STARTER**

\$129⁰⁰

**1100 PEAK AMPS
300 CRANK AMPS**

- 19-inch Cable Length • 12VDC Output • #4 AWG Cables
- HotJaw™ Clamps • LED Battery Status Indicators



**SOR ES5000
12V JUMP STARTER**

\$149⁰⁰

**1500 PEAK AMPS
400 CRANK AMPS**

- 43-inch Cable Length • 12VDC Output • #4 AWG Cables
- HotJaw™ Clamps • LED Battery Status Indicators



**SOR ES6000
12V JUMP STARTER**

\$299⁰⁰

**3000 PEAK AMPS
800 CRANK AMPS**

- 54-inch Cable Length • 12VDC Output • #4 AWG Cables
- HotJaw™ Clamps • LED Battery Status Indicators



**SOR ES1224
12/24V JUMP STARTER**

\$399⁰⁰

**3000 PEAK AMPS
12V MODE
750 CRANK AMPS
12V MODE**

- 60-inch Cable Length • 12VDC Output • #2 AWG Cables
- HotJaw™ Clamps • LED Battery Status Indicators

PRO-LOGIX DIAGNOSTIC REFLASHING POWER SUPPLIES AND BATTERY CHARGERS

OPTIMAL REPROGRAMMING SUPPORT

SOR PL6850 - 12/24V HD Reflashing 120A Power Supply and 120/60/40/10A Battery Charger

LITHIUM -LiFePO4- OPTIMIZED

120A MAX CHARGE

12/24 VOLT

AGM R.E.A.D.Y.

Limited Warranty
1
WARRANTY
One Year

\$849⁰⁰

0-120A (On Demand) Power Supply Mode	13.1V - 14.9V Adjustable 12V Power Supply
12 Volt 120 Max Charge Perfect for 4-Battery Packs	0-60A (On Demand) 24V Power Supply Mode
26.2 - 29.8V Adjustable 24V Power Supply	13' Cable Reach with #2 AWG Cables



Watch Now

Learn more about Diagnostic Reflashing Power Supplies and Battery Chargers

SOR PL6100 - 12V Reflashing 100A Power Supply and 60/40/10A Battery Charger

\$649⁰⁰

60A MAX CHARGE

AGM R.E.A.D.Y.

0-100A (On Demand) Power Supply Mode	13.1V - 14.9V Adjustable Power Supply	Rapid Load Response (RLR) Technology
Minimal Voltage Ripple ($<100\text{mV}$)	Reprogramming and ADAS Calibration	13' Cable Reach with #2 AWG Cables



REFLASHING UNITS FEATURE:

- Manages Sulfated Batteries
- Precise Voltage Control

- Automatic Charging Mode
- Power Supply Mode
- Temperature Compensation

- Charges Variety of Battery Types
- Reverse Polarity Protection
- Forced Start Mode

- Battery Repair Mode
- Battery Fault Detection
- PowerJaw™ Clamps

- Digital Display
- 1 Year Warranty
- AGM Ready

All reflashing power supplies require 20A service.



BATTERY MAINTAINERS & WHEEL CHARGERS

SOR PL2112 - 1.0A 12 Volt Battery Maintainer



\$39⁹⁹

SOR 1002 - 1.5A 12 Volt Underhood Maintainer



\$43⁹⁹

SOR PL3740 - 12V Wheeled Charger with 225A Engine Start



\$325⁰⁰

- 40/15/5/225A
- Stable Power Mode
- Engine Start
- Analog Knob Controls
- Timed Charge Routines
- Automatic Charge Mode
- Ships Fully Assembled
- 2 Year Warranty

SOR PL4020 - 2 AMP X 4



\$195⁰⁰

- 12V, 2 Amp x 4
- Automatic Operation
- 4 Independent Channels
- Quick Attach Connectors

SOR PL4050 - 5 AMP X 4



\$250⁰⁰

- 6/12V, 5 Amp x 1
- 12V, 5 Amp x 3
- 4 Independent Channels
- Forced Start Capability

SOR PL3760 - 12/24V Wheeled Charger with 250A Engine Start



\$579⁰⁰

- 60<->40/40/10A (12V)
- 20/10A 24V Charging Rates
- Fully Automatic
- Data Rich Display
- Charges Multiple Battery Types
- Charges Totally Dead Batteries
- Stable Power Mode
- 2 Year Warranty

CHARGE IT!



SOR 4735 BATTERY CHARGER with 200 AMP ENGINE START

- 40/10/2/200A
- Fully Automatic Operation
- Reverse Polarity Protection
- 7-Segment Display
- Full-Size Clamps
- Battery Fault Detection

\$195⁰⁰



SOR 4745 BATTERY CHARGER with 230 AMP ENGINE START

- 12V - 40/10/2/230A
- 24V - 20/2A
- Fully Automatic Operation
- Reverse Polarity Protection
- 7-Segment Display
- Full-Size Clamps
- Battery Fault Detection

\$310⁰⁰



SOR 4506 - 6/12V, 6/2A BATTERY CHARGER

\$49⁹⁹



SOR 4512 - 12V, 12/6/2A BATTERY CHARGER

\$69⁹⁹



SOR 4520 - 12V, 20/10/2A BATTERY CHARGER

\$79⁹⁹



SOR 1852 6/12V 100A FIXED LOAD TESTER

\$33⁹⁹

- For 6 and 12 Volt Batteries
- Graduated Scale
- 18" Cable Reach
- Tests to 1000 Cold Cranking Amps
- Color-Coded Full-Size Meter



SOR BA9 12V DIGITAL BATTERY & SYSTEM TESTER

\$69⁹⁹

- 4.5 to 16V Operating Range
- 40 to 1200 CCA Testing
- Tests Multiple Battery Types
- 21" Cable Reach
- LCD Digital Display



SOR BA227 - 12V DIGITAL BATTERY & SYSTEM TESTER WITH INTEGRATED PRINTER

\$245⁰⁰

- 6.5 to 15V Operating Range
- 100 to 1400 CCA Testing
- Temperature Compensation
- Tests Multiple Battery Types
- Long 36-inch leads



SOR BA327 - 6/12V DIGITAL BATTERY AND SYSTEM TESTER WITH INTEGRATED PRINTER

\$425⁰⁰

- 6/12V Battery Testing
- 1.5-30V Operating Range
- 40-2000 CCA Testing Range
- Extra-Long 10' Leads
- Temperature Compensation
- Replaceable Cable Ends



FACTORY DIRECT

TOPDON BATTERY SERVICE



\$229

#TDN V4500PLUS

V4500PLUS

2-in-1 4500 Peak Amp Jump Starter & Battery/System Tester

- 4500 peak amp jump starter
- Jumps up to 16L gas and 16L diesel engines
- Built-in battery testing function
- Boost mode up to 3 minutes



\$89.99

#TDN V1500

V1500

1500A Jump Starter & Booster, Power Bank & Flashlight

- 1500 peak amp jump starter
- Jumps up to 6.5L gas and 4.0L diesel engines
- Compact portable lithium design
- USB output for device charging



\$148.99

#TDN V2200AIR

V2200AIR

2-in-1 2200 Peak Amp Jump Starter & Tire Inflator

- 2200 peak amp jump starter
- Jumps up to 8.0L gas and 6.0L diesel engines
- Integrated tire inflator with display
- Built-in flashlight for low-light use
- USB outputs for device charging



\$139

#TDN BT600

BT600

12V Battery & 12V/24V System Tester w/Built-in Printer

- Tests 12V batteries and charging systems
- Displays SOH, SOC, and test results
- Supports AGM, GEL, EFB, and Flooded batteries
- Built-in thermal printer for reports

Chargers



\$299

#TDN T30000

Tornado30000

30A Smart Charger and Power Supply 12V/24V

- 360W maximum output
- Supports 6V, 12V, and 24V batteries
- Suitable for multiple battery types, including AGM, LI, WET, GEL, MF CAL, and EFB
- Offers 3 charging currents: 30A, 15A, and 10A



\$799

#TDN T1200005

Tornado120000

120A Stable Power Supply & 12V Battery Charger

- 1700W maximum output
- 120A stable power for ECU programming
- Adjustable voltage and current output
- 9-step smart battery charging
- Supports 12V lead-acid and lithium batteries



\$699

#TDN T90000

Tornado90000

90A Stable Power Supply & Smart Charger 12V/24V

- 1500W maximum output
- 90A stable 12V/24V output
- ECU programming voltage stabilizer
- 9-step smart battery charging
- Supports AGM, GEL, EFB, Lithium



STARTING AT \$99.99

NNO GB40	Boost 12V 1000A Jump Starter	\$99.99
NNO GB70	Boost 12V 2000A Jump Starter	\$199.99
NNO GB150	Boost 12V 3000A Jump Starter	\$299.99
NNO GB250	Boost 12V 5250A Jump Starter	\$1,200



NOCO genius STARTING AT \$29.99

NNO GENIUS1	Genius1 1A Battery Charger	\$29.99
NNO GENIUS5	Genius5 5A Battery Charger	\$69.99
NNO GENIUS10	Genius 10 10A Battery Charger	\$99.99



NNO GBX55	Boost X 12V 1750A Jump Starter	\$174.99
NNO GBX75	Boost X 12V 2500A Jump Starter	\$249.99
NNO GBX155	Boost X 12V 4250A Jump Starter	\$369.99

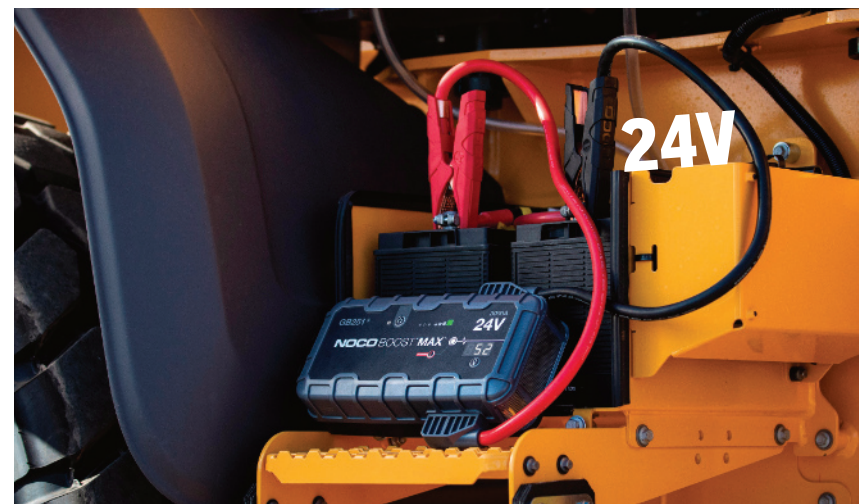

NNO GB251 Boost Max 24V 3000A Jump Starter \$120.85 For 12 \$1,200

\$210⁹⁹ /each

NAPA Jump Starter with Digital Compressor
BK JS1600AC

- 1600 Peak Amps
- Digital Auto Stop
- 120 PSI Compressor
- 3 USB Outlets
- Rotating Work light



\$203⁹³ /each

VECTOR Lithium Jump Starter with Digital Compressor
BK MJ16V

- 1600 Peak Amps
- Digital Auto Stop
- 120 PSI Compressor
- USB-A & USB-C Power Ports



WORKS WITH ENGINES UP TO V8



\$225⁹⁹ /each

NAPA 40 AMP Wheeled Charger with 200A Engine Start
BK BC200N

- 0-40 Automatic Charger
- 200 A Engine Start
- Alternator Check
- Battery Recondition



\$48⁹⁹ /each

NAPA 4Amp WaterProof Charger
BK BC4WN

- Waterproof housing
- Clamps and O ring connectors
- Mounting Bracket
- Magnetic base
- Reverse Polarity Protection
- Automatic Charging



\$231²⁸ /each

NAPA 1600 Peak Amp Powerstation
BK JS1600ACI

- Jump Starter
- 500 Watt AC Power
- Digital Auto Stop
- 120 PSI Compressor
- USB/12 Volt DC outlets



NBC DSR140	Battery Charger	\$229
NBC DSR164	12v 4000a Lith Jump	\$354
NBC DSR166	Jump Starter 12v/24v	\$399.99



IR 2236QTIMAX



IR W8171K2



IR 3445MAX

IR 2115TIMAX	3/8in Composite Impact Wrench	Was \$415.99	Now \$269.99
IR 2236QTIMAX	1/2" Air Impact Wrench	Was \$544.99	Now \$369.99
IR 3445MAX	Angle Grinder	Was \$478.99	Now \$399.99
IR W8171K2	3/4" Impact Wrench Battery Kit	Was \$1,190	Now \$999.99
IR W8191K2	1" Impact Wrench Battery Kit	Was \$1,270	Now \$1,099.99
IR W9691K4E	1" Cordless Impact Wrench Kit	Was \$2,370	Now \$1,599.99





MARKET DRIVEN INNOVATION

M12 FUEL
Extended Reach Ratchets

SHIPS JULY 2026

LONGER REACH
MOST COMPACT
HEAD & BODY

**BEST
COMBINATION OF
POWER & SPEED**

**UNMATCHED
COMFORT**

M12 FUEL
1/2" Extended Reach
Ratchet - Tool Only
3055-20



M12 FUEL
1/4" Extended
Reach Ratchet Kit
3058-21
3058-20 Tool Only



M12 FUEL
3/8" Extended
Reach Ratchet
3059-21
3059-20 Tool Only



M12 FUEL
STRIKER™ Hammer Chisel

SHIPS OCTOBER 2026

World's First Battery Operated Hammer Chisel

M12 FUEL
STRIKER™ Hammer
Chisel Kit
3771-21
3771-20 Tool Only



**5PC Hammer
Chisel Bit Set**
49-16-3776





TO CLAIM YOUR FREE ITEM(S)

PLEASE GO TO WWW.MILWAUKEETOOL.COM/E-REBATES/NAPA OR **SCAN THE QR CODE** ON THIS PAGE.

Redemptions must be completed by October 15, 2026. For NAPA online orders, please enter NAPAWEB when prompted for a zip code.



SCAN TO REDEEM

PURCHASE A QUALIFYING **M12** BARE TOOL

\$169⁹⁹



M12™ Radio + Charger - Tool Only MIL 2951-20

\$149⁹⁹



M12 FUEL™ 1/2" Drill/Driver - Tool Only MIL 3403-20

\$199⁹⁹



M12™ Spot Polisher - Tool Only MIL 2438-20

\$269⁹⁹



M12 FUEL™ 1/2" X 18" Bandfile - Tool Only MIL 2482-20

\$269⁹⁹



M12 FUEL™ 3/8" X 13" Bandfile - Tool Only MIL 2483-20

GET THIS **FREE**



M12™ REDLITHIUM™ HIGH OUTPUT™ CP2.5 Battery MIL 48-11-2425

BUY THIS

\$149⁹⁹

M12™ REDLITHIUM™ XC4.0 Battery - 2PK MIL 48-11-2442



YOUR CHOICE **FREE**

M12™ Cordless 3/8" Right Angle Drill/Driver (Tool Only) MIL 2415-20



M12 FUEL™ 1/4" Hex Impact Driver (Tool Only) MIL 3453-20



M12™ Soldering Iron (Tool Only) MIL 2488-20



BUY ONE OF THESE

BUY TWO M12 REDLITHIUM HIGH OUTPUT XC5.0 BATTERIES (MIL 48-11-2450) FOR \$199 USING INSTANT REBATE CODE MIL MTINSTANT60 *\$129.99 each



\$599⁹⁹

M12 FUEL™ 3-Tool Combo Kit MIL 3424-23



YOUR CHOICE **FREE**

M12™ Stick Transfer Pump (Tool Only) MIL 2579-20



M12™ 3/8" Ratchet (Tool Only) MIL 2457-20



M12 FUEL™ 3" Compact Cut Off Tool (Tool Only) MIL 2522-20



M12 FUEL™ 1.6 Gallon Wet/Dry Vacuum (Tool Only) MIL 0960-20



PURCHASE A QUALIFYING **M12** KIT OR BARE TOOL

\$229⁹⁹

M12 FUEL™ 1/4" Right Angle Die Grinder (Tool Only) MIL 3485-20



\$202⁹⁹

M12 FUEL™ HACKZALL® Recip Saw Kit MIL 2520-21XC



\$219⁹⁹

M12™ Underbody Light (Tool Only) MIL 2126-20



\$329⁹⁹

M12™ FUEL™ 6" Random Orbital Sander MIL 2584-20



\$261⁹⁹

M12 FUEL™ 2-Tool Combo Kit MIL 3497-22



\$251⁹⁹

M12 FUEL™ 1/2" Right Angle Impact Wrench w/ Friction Ring (Tool Only) MIL 2565-20



\$251⁹⁹

M12 FUEL™ 3/8" Right Angle Impact Wrench w/ Friction Ring (Tool Only) MIL 2564-20



\$249⁹⁹

M12 FUEL™ Stubby 3/8" Impact Wrench (Tool Only) MIL 2562-20



\$249⁹⁹

M12 FUEL™ Stubby 1/2" Impact Wrench (Tool Only) MIL 2563-20



\$279⁹⁹

M12™ Rivet Tool (Tool Only) MIL 2550-20



\$220⁹⁹

M12™ Underhood Light (Tool Only) MIL 2125-20



\$299⁹⁹

M12 FUEL™ INSIDER™ Extended Reach Box Ratchet (Tool Only) MIL 3050-20



GET THIS **FREE**



M12™ REDLITHIUM™ HIGH OUTPUT™ XC5.0 Battery MIL 48-11-2450

PURCHASE A QUALIFYING **M18** KIT, BARE TOOL OR CHARGER

\$411⁹⁹

M18 FUEL™ 2-Tool Combo Kit MIL 3697-22



\$249⁹⁹

M18 FUEL™ 3/8" Compact Impact Wrench w/ Friction Ring (Tool Only) MIL 2854-20



\$249⁹⁹

M18 FUEL™ 1/2" Compact Impact Wrench w/ Friction Ring (Tool Only) MIL 2855-20



\$279⁹⁹

M18 FUEL™ 3/8" Mid-Torque Impact Wrench w/ Friction Ring (Tool Only) MIL 2960-20



\$299⁹⁹

M18 FUEL™ 1/2" High Torque Impact Wrench with Friction Ring (Tool Only) MIL 2967-20



\$199⁹⁹

M18 FUEL™ 2.5 Gallon Wet/Dry Vacuum w/ PACKOUT™ Compatibility (Tool Only) MIL 0970-20



\$199⁹⁹

M18 FUEL™ Hackzall® (Tool Only) MIL 2719-20



\$249⁹⁹

M18 FUEL™ Oscillating Multi-Tool (Tool Only) MIL 2836-20



\$279⁹⁹

M18 FUEL™ HATCHET™ 8" Pruning Saw (Tool Only) MIL 3004-20



\$229⁹⁹

M18 FUEL™ 1/2" Hammer Drill/Driver (Tool Only) MIL 2904-20



\$219⁹⁹

M18 FUEL™ 1/2" Drill/Driver (Tool Only) MIL 2903-20



\$229⁹⁹

M18 FUEL™ 4-1/2" / 5" Grinder Paddle Switch, No-Lock (Tool Only) MIL 2880-20



\$279⁹⁹

M18™ Six Bay Rapid Charger w/ PACKOUT™ Compatibility MIL 48-59-1809



GET THIS **FREE**



M18™ REDLITHIUM™ XC5.0 Resistant Battery MIL 48-11-1850R



COMMODORE FINANCING



PURCHASE A QUALIFYING M18 TOOL

GET THIS FREE

\$279⁹⁹

M18 FUEL™ 4-1/2"-6" Braking Grinder, Paddle Switch (Tool Only) MIL 3670-20



\$329⁹⁹

M18 FUEL™ 15mm Random Orbital Polisher (Tool Only) MIL 2684-20



\$349⁹⁹

M18 FUEL™ 21mm Random Orbital Polisher (Tool Only) MIL 2685-20



\$329⁹⁹

M18 FUEL™ 7" Variable Speed Polisher (Tool Only) MIL 2738-20



M18™ REDLITHIUM™ HIGH OUTPUT™ XC6.0 Battery MIL 48-11-1865

BUY ONE OF THESE

\$129⁹⁹

M18™ Compact Blower (Tool Only) MIL 0884-20



\$179⁹⁹

M18™ ROVER™ Dual Power Flood Light (Tool Only) MIL 2366-20



\$200⁹⁹

M18™ ROVER™ Dual Power Triple-Panel Flood & Area Light (Tool Only) MIL 2368-20



GET THIS FREE

M18™ REDLITHIUM™ CP2.0 Battery MIL 48-11-1820



BUY THIS

\$159⁹⁹

M18™ 2-Gallon Wet/Dry Vacuum (Tool Only) MIL 0880-20



GET THIS FREE

HEPA Filter MIL 49-90-1900



BUNDLE & SAVE \$150

BUY ONE OF THESE KITS + ONE OF THESE BARE TOOLS OR BATTERIES

USE CODE MTINSTANT150 FOR INSTANT REBATE

\$411⁹⁹

M18 FUEL™ 2-Tool Combo Kit MIL 3697-22



\$329⁹⁹

M18 FUEL™ 1/2" Drill/Driver Kit MIL 2903-22



\$347⁹⁹

M18 FUEL™ 1/2" Hammer Drill/Driver Kit MIL 2904-22



\$330⁹⁹

M18 FUEL™ 1/4" Hex Impact Driver Kit MIL 2953-22



\$499⁹⁹

M18 FUEL™ 1/2" HTIW w/ Friction Ring Kit MIL 2967-22



\$199⁹⁹

M18 FUEL™ HACKZALL® (Tool Only) MIL 2719-20



\$309⁹⁹

M18™ REDLITHIUM™ XC5.0 Resistant Battery - 2PK MIL 48-11-1852R



\$249⁹⁹

M18 FUEL™ SAWZALL® Recip Saw (Tool Only) MIL 2821-20



\$250⁹⁹

M18™ ROCKET™ Dual Power Tower Light (Tool Only) MIL 2131-20



NEW LOWER PRICING

Was \$139⁹⁹
Now \$119

M12™ Compact Inflator (Tool Only) MIL 2475-20



\$21 SAVINGS

Was \$369⁹⁹
Now \$299

M18™ Cordless 2-Speed Grease Gun Kit MIL 2646-21CT



\$70 SAVINGS

Was \$164⁹⁹
Now \$119⁹⁹

29PC RED HELIX™ Cobalt Drill Bit Set Set MIL 48-89-2332



\$45 SAVINGS

Was \$29⁹⁹
Now \$24⁹⁹

16PC Metal Cutting Sawzall Blade Set MIL 49-22-1216



\$5 SAVINGS

Was \$349⁹⁹
Now \$299

M18™ and M12™ Gangbox Rapid Charger MIL 48-59-1804



\$50 SAVINGS

Was \$69⁹⁹
Now \$59⁹⁹

Rechargeable Low-Profile Magnetic Task Light MIL 2013R



\$10 SAVINGS

Was \$199⁹⁹
Now \$149

M18 FUEL™ Blower (Tool Only) MIL 3017-20



\$51 SAVINGS

Was \$329⁹⁹
Now \$279

M18 FUEL™ 16" Chainsaw (Tool Only) MIL 2727-20



\$51 SAVINGS

Was \$29⁹⁹
Now \$24⁹⁹

6PC Precision Screwdriver Set w/ Case MIL 48-22-2606



\$5 SAVINGS

Was \$84⁹⁹
Now \$69⁹⁹

5PC TORQUE LOCK™ Pliers Kit MIL 48-22-3695

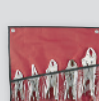

\$15 SAVINGS

Was \$21⁹⁹
Now \$15⁹⁹

FASTBACK™ Folding Utility Knife Set MIL 48-22-1503



\$6 SAVINGS

Was \$13⁹⁹
Now \$11⁹⁹

General Purpose Utility Blades MIL 48-22-1950



\$2 SAVINGS

Was \$109⁹⁹
Now \$94⁹⁹

Jobsite Backpack MIL 48-22-8200



\$15 SAVINGS

Was \$84⁹⁹
Now \$74⁹⁹

PACKOUT™ Cooler MIL 48-22-8302



\$10 SAVINGS

Was \$51⁹⁹
Now \$41⁹⁹

PACKOUT™ Large Wall Plate MIL 48-22-8497



\$10 SAVINGS

Was \$25⁹⁹
Now \$20⁹⁹

PACKOUT™ Compact Wall Plate MIL 48-22-8496



\$5 SAVINGS

Was \$31⁹⁹
Now \$25⁹⁹

PACKOUT™ Mounting Plate MIL 48-22-8485



\$6 SAVINGS

Was \$42⁹⁹
Now \$34⁹⁹

PACKOUT™ Tool Station MIL 48-22-8343



\$8 SAVINGS

Was \$25⁹⁹
Now \$20⁹⁹

PACKOUT™ Compact Wall Basket MIL 48-22-8342



\$5 SAVINGS

Was \$24⁹⁹
Now \$19⁹⁹

PACKOUT™ M18™ Battery Rack MIL 48-22-8339



\$5 SAVINGS

Was \$19⁹⁹
Now \$15⁹⁹

PACKOUT™ M12™ Battery Rack MIL 48-22-8338



\$4 SAVINGS

Was \$99⁹⁹
Now \$79⁹⁹

12PC SHOCKWAVE™ Impact Duty 1/2" Drive SAE Deep 6 Point Socket Set MIL 49-66-7011



\$20 SAVINGS

Was \$224⁹⁹
Now \$199⁹⁹

36PC SHOCKWAVE™ Impact Duty Socket 3/8" Drive Set w/ PACKOUT™ MIL 49-66-6805



\$25 SAVINGS

Was \$104⁹⁹
Now \$79⁹⁹

14PC SHOCKWAVE™ Impact Duty 1/2" Drive Metric Deep 6 Point Socket Set MIL 49-66-7014



\$25 SAVINGS

Was \$179⁹⁹
Now \$149⁹⁹

27PC SHOCKWAVE™ Impact Duty Socket 1/2" Drive MM & SAE Set w/ PACKOUT™ MIL 49-66-6804



\$30 SAVINGS

Was \$84⁹⁹
Now \$49⁹⁹

12PC SHOCKWAVE™ Impact Duty 3/8" Drive SAE Deep 6 Point Socket Set MIL 49-66-7006



\$35 SAVINGS

Was \$74⁹⁹
Now \$49⁹⁹

14PC SHOCKWAVE™ Impact Duty 3/8" Drive Metric Deep 6 Point Socket Set MIL 49-66-7008

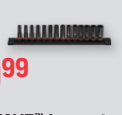

\$30 SAVINGS

Was \$114⁹⁹
Now \$74⁹⁹

3PC Step Drill Bit Set MIL 48-89-9221



\$40 SAVINGS

Was \$24⁹⁹
Now \$19⁹⁹

4PC M2 Steel Screw Extractor Set MIL 49-57-9001



\$5 SAVINGS

DEWALT®

GET UP TO \$75 INSTANT REBATE*

TRADE IN YOUR OLD TOOLS & TRADE UP WITH AN INSTANT REBATE

*a working or non-working hand-held power tool

Get an instant rebate of \$75 off select tools* using code DEW DWINSTANT75

 <p>\$714⁹⁹ REGULAR PRICE</p> <p>20V MAX* XR® 1/2 In. HT Impact Wrench* DEW DCF961GH1</p>	 <p>\$317⁹⁹ REGULAR PRICE</p> <p>20V MAX* BL 4-1/2 In. Grinder Kit* DEW DCG407P1</p>	 <p>\$376⁹⁹ REGULAR PRICE</p> <p>20V MAX* XR® 5 In. Variable Polisher* DEW DCM848B</p>	 <p>\$944⁹⁹ REGULAR PRICE</p> <p>20V MAX* XR® 1/4 In. Rivet Tool* DEW DCF414B</p>	 <p>\$359⁹⁹ REGULAR PRICE</p> <p>20V MAX* XR® 3/8 In. & 1/2 In. Ratchet Kit* DEW DCF510GE1</p>	 <p>\$311⁹⁹ REGULAR PRICE</p> <p>20V MAX* 5Ah Battery (2 PK)* DEW DCB2052</p>
 <p>\$447⁹⁹ REGULAR PRICE</p> <p>60V MAX* FLEXVOLT Cordless Chain Saw Kit* DEW DCCS670X1</p>	 <p>\$470⁹⁹ REGULAR PRICE</p> <p>20V MAX* 2-Speed Grease Gun Kit* DEW DCGG581GD1</p>				

Get an instant rebate of \$50 off select tools* Using code DEW DWINSTANT50

 <p>\$390⁹⁹ REGULAR PRICE</p> <p>20V MAX* XR® 1/2 In. HT Impact Wrench Kit* DEW DCF900P1</p>	 <p>\$433⁹⁹ REGULAR PRICE</p> <p>20V MAX* XR® 1/2 In. Hammer Drill Kit* DEW DCD1007WW1</p>	 <p>\$308⁹⁹ REGULAR PRICE</p> <p>20V MAX* XR® 3/16 In. Rivet Tool* DEW DCF403B</p>	 <p>\$453⁹⁹ REGULAR PRICE</p> <p>60V MAX* BL 4-1/2 In. - 6 In. Grinder w/ KICKBACK BRAKE™ Kit* DEW DCG418X1</p>	 <p>\$309⁹⁹ REGULAR PRICE</p> <p>20V MAX* XR® BL Cordless Pole Saw Kit* DEW DCPS620M1</p>	 <p>\$294⁹⁹ REGULAR PRICE</p> <p>20V MAX* 12 In. Compact BL Chain Saw Kit* DEW DCCS621P1</p>	 <p>\$326⁹⁹ REGULAR PRICE</p> <p>20V MAX* XR® BL Drill Driver Kit* DEW DCD801H1</p>
--	--	--	--	--	--	---

* Store personnel use codes DEW DWINSTANT75 or DEW DWINSTANT50 for instant rebate. (Store personnel are required to photograph all trade-in tools prior to disposal.)
*Maximum initial battery voltage (measured without a workload) is 20 volts. Nominal voltage is 18 volts. Offers valid while supplies last. Products shown in the ad above are direct ship only.





 <p>FASTFIT® BLACK Was \$29⁹⁹ Now \$14⁹⁹</p> <p>S BK 7631239 M BK 7631240 L BK 7631241 XL BK 7631242 XXL BK 7631243</p>	 <p>ORIGINAL® BLACK Was \$33⁹⁹ Now \$22⁹⁹</p> <p>S BK 7631110 M BK 7631111 L BK 7631112 XL BK 7631113 XXL BK 7631114</p>	 <p>SPECIALTY GRIP BLACK Was \$39⁹⁹ Now \$24⁹⁹</p> <p>M BK MSG05009 L BK MSG05010 XL BK MSG05011 XXL BK MSG05012</p>	 <p>M-PACT® BLACK Was \$37⁹⁹ Now \$28⁹⁹</p> <p>M BK 7631257 L BK 7631258 XL BK 7631259 XXL BK 7631260</p>	 <p>SPEEDKNIT™ BLACK Was \$19⁹⁹ Now \$8⁹⁹</p> <p>S/M BK S1DE05500 L/XL BK S1DE05540</p>
--	--	--	---	---



-  **ENHANCED DURABILITY**
-  **IMPROVED COMFORT + FIT**
-  **INCREASED DEXTERITY**

JET LIFTING SYSTEMS

S90 SERIES HAND CHAIN HOISTS

REG PRICE \$259.99
\$220⁹⁹

S90-100-10, Hand Chain Hoist 1 Ton 10' Lift
JET 101910



AL100 SERIES MANUAL CHAIN HOISTS

REG PRICE \$564.99
\$480²⁴

AL100-050-20, Aluminum Chain Hoist 1/2 Ton 20' Lift
JET 133053

REG PRICE \$459.99
\$390⁹⁹

AL100-100-10, Aluminum Chain Hoist 1 Ton 10' Lift
JET 133110

REG PRICE \$529.99
\$450⁴⁹

AL100-100-15, Aluminum Chain Hoist 1 Ton 15' Lift
JET 133115



JLP- A SERIES MINI PULLERS

REG PRICE \$189.99
\$161⁴⁹

JLP-025A-5, 1/4 Ton Mini-Puller, 5' Lift
JET 287100

REG PRICE \$288.99
\$245⁶⁴

JLP-050A-10, 1/2 Ton Mini-Puller, 10' Lift
JET 287201



JLP- A SERIES LEVER HOISTS

REG PRICE \$370.99
\$315³⁴

JLP-075A-10, 3/4 Ton Lever Hoist, 10' Lift
JET 287301

REG PRICE \$446.99
\$379⁹⁴

JLP-150A-10, 1-1/2 Ton Lever Hoist with 10' Lift
JET 287401



WILTON

CLASSIC SERIES F-CLAMP KIT

REG PRICE \$186.99
ASK FOR PROMO PRICING

Classic Series F-Clamp Kit - Contains 4 Lightweight F-Clamps
JET 11116



B.A.S.H. UNBREAKABLE HANDLE TECHNOLOGY

REG PRICE \$76.99
\$65⁴⁴

B.A.S.H 4lb. Head 12" Unbreakable Steel Core Handle Sledge Hammer
JET 20412

REG PRICE \$174.99
\$148⁷⁴

B.A.S.H 10lb. Head 30" Unbreakable Steel Core Handle Sledge Hammer
JET 21030



REG PRICE \$70.99
\$60³⁴

B.A.S.H Dead Blow Hammer, Soft Face, 1-3/4" Diameter Face 2lb Head
JET 55214

REG PRICE \$104.99
\$89²⁴

B.A.S.H Dead Blow Hammer, Soft Face, 2-1/4" Diameter Face 4lb Head 16" Handle
JET 55416



GEARWRENCH

NEW SNAP RING PLIERS

- **Quick Switch Push Button**
Effortlessly transitions pliers between internal and external snap rings
- **High-Strength, Conical Tip Design**
Locks into snap ring



Item No.	Description	Price
APX 89710	12 Piece Push Button Convertible Snap Ring Pliers Set	\$189.99
APX 89711	6 Piece Push Button Convertible Snap Ring Pliers Set	\$99.99
APX 89712	4 Piece Push Button Convertible Snap Ring Pliers Set	\$69.99

NEW AUTO HAMMERS

- **Shock-Absorbing Dead Blow Technology**
Minimizes rebound and maximizes impact force for precise, efficient striking
- **Dual-Function Ball Pein Head**
For shaping metal, riveting, and rounding edges, while the flatface handles general striking tasks



Item No.	Description	Price
APX GWH3PCBP	3 Piece Ball Pein Hammer Set	\$64.99
APX GWH3PCDB	3 Piece Dead Blow Hammer Set	\$89.99
APX GWH3PCDBBP	3 Piece Dead Blow Ball Pein Hammer Set	\$139.99
APX GWH5PCDB	5 Piece Dead Blow Hammer Set	\$164.99

TORQUE TOOLS

- **Teardrop Low Profile Head & Flush Mounted On/Off Switch**
Allows better access in tight spaces
- **Torque accuracy of +/- 3% CW**
In the upper 80% of wrench capability for high performance



Item No.	Description	Price
APX 85076	3/8" Drive Electronic Torque Wrench 10-100 ft/lbs	\$229.99
APX 85077	1/2" Drive Electronic Torque Wrench 25-250 ft/lbs	\$239.99
APX 85079	1/2" Drive Flex Head Electronic Torque Wrench with Angle 25-250 ft/lb	\$299.99
APX 85171	1/4" Drive 120XP™ Micrometer Torque Wrench 30-200 in/lbs.	\$169.99
APX 85176	3/8" Drive 120XP™ Micrometer Torque Wrench 10-100 ft/lb	\$179.99
APX 85181	1/2" Drive 120XP™ Micrometer Torque Wrench 30-250 ft/lbs.	\$239.99
APX 85194	1/4" Drive 120XP™ Flex Head Electronic Torque Wrench with Angle	\$249.99
APX 85195	3/8" Drive 120XP™ Flex Head Electronic Torque Wrench with Angle	\$259.99
APX 85196	1/2" Drive 120XP™ Flex Head Electronic Torque Wrench with Angle	\$289.99

Item No.	Description	Price
APX 89620	20 Piece 1/4" Drive Torque Screwdriver Set 10-50 in/lb	\$179.99
APX 89624	1/4" Drive Torque Screwdriver 10-50 in/lbs	\$119.99
APX 85060M	1/4" Drive Micrometer Torque Wrench 30-200 in-lb.	\$144.99
APX 85061M	3/8" Drive Micrometer Torque Wrench 30-250 in/lbs.	\$149.99
APX 85062M	3/8" Drive Micrometer Torque Wrench 10-100 ft/lbs.	\$139.99
APX 85063M	1/2" Drive Micrometer Torque Wrench 20-150 ft/lbs.	\$144.99
APX 85066M	1/2" Drive Micrometer Torque Wrench 30-250 ft/lbs.	\$149.99
APX 85068	1" Drive Micrometer Torque Wrench 200-1000 ft/lbs.	\$1,499.99
APX 85088M	1/2" Drive Tire Shop Micrometer Torque Wrench 30-250 ft/lb	\$149.99

TOOL SETS

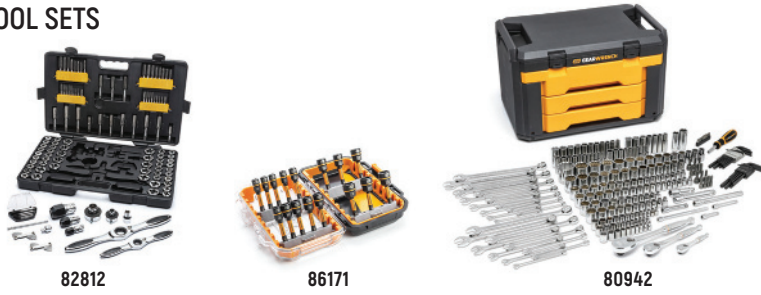

Item No.	Description	Price
APX 3887	77 Piece SAE/Metric Ratcheting Tap and Die Set	\$169.99
APX 82812	114 Piece SAE/Metric Ratcheting Tap and Die Set	\$299.99
APX 86171	16 Piece Bolt Biter™ Nut Extractor & Driver Set	\$119.99
APX GW72SCBMTS	121 Piece 1/4" & 3/8" Drive 72-Tooth SAE/Metric Mechanics Hand Tool Set	\$94.99
APX GW72MCBMTS	185 Piece 1/4", 3/8" & 1/2" Drive 72-Tooth SAE/Metric Mechanics Hand Tool Set	\$139.99
APX 80300P	51 Piece 1/4" Drive 6 Point 120XP™ Standard and Deep SAE/Metric Mechanics Tool Set	\$99.99
APX 80550P	56 Piece 3/8" Drive 6 Point 120XP™ Standard and Deep SAE/Metric Mechanics Tool Set	\$124.99
APX 80742	84 Piece 1/4", 3/8" & 1/2" Drive Hex/Ball End Hex/Tamper Proof Torx®/External Torx®/Torx® SAE/Metric Bit Set	\$169.99
APX 80942	239 Piece Mechanics Tool Set in 3 Drawer Storage Box	\$329.99
APX 80944	232 Piece Mechanics Tool Set in 3 Drawer Storage Box	\$299.99
APX 80966	243 Piece 6 Point Mechanics Tool Set in 3 Drawer Storage Box	\$359.99
APX 80972	243 Piece 12 Point Mechanics Tool Set in 3 Drawer Storage Box	\$359.99
APX 89060	613 Piece Master Mechanics Hand Tool Set	\$2,299.99
APX GW38CBMTS75	75 Piece 1/4", 3/8" & 1/2" Drive SAE/Metric Mechanics Tool Set	\$69.99
APX GW72MLCBMTS	202 Piece 1/4", 3/8" & 1/2" Drive SAE/Metric Mechanics Tool Set	\$109.99
APX GWPRO138	138 Piece 1/4" & 3/8" Drive 72-Tooth 6 Point Professional Tool Set	\$129.99
APX GWPRO168	168 Piece 1/4" & 3/8" Drive 72-Tooth 6 Point Professional Tool Set	\$179.99

RATCHETS & RATCHETING WRENCHES



Item No.	Description	Price
APX 81274T	2 Piece 1/4" & 3/8" Drive 90-Tooth Locking Flex Head Teardrop Ratchet Set	\$64.99
APX 39327	32 Piece 72-Tooth 12 Point SAE/Metric Standard/Stubby Combination Ratcheting Wrench Set	\$149.99
APX 81919	44 Piece 12 Point Long Pattern Combination SAE/Metric Wrench Set	\$369.99
APX 86126	10 Piece 120XP™ Universal Spline XL Flex Head GearBox™ Ratcheting Metric Wrench Set	\$319.99
APX 86142	10 Piece 120XP™ Universal Spline XL Flex Head GearBox™ Ratcheting SAE Wrench Set	\$319.99
APX 85988	12 Piece 72-Tooth 12 Point XL GearBox™ Double Box Ratcheting Metric Wrench Set	\$239.99

FANS & AIR MOVERS



Item No.	Description	Price
APX GWAM1800	1800 CFM Industrial Air Mover	\$319.99
APX GWAM800	800 CFM Compact Air Mover	\$144.99
APX GWSFAN20	20" 3-Speed High Velocity Shop Fan	\$89.99
APX GWSFAN24	24" 2-Speed High Velocity Shop Fan	\$189.99



GEARWRENCH



SCAN FOR ALL YOUR GEARWRENCH NEEDS

From hand tools to storage, upgrade your tool box with our most innovative products for the speed, strength, and access you need to forge ahead



WE KNOW WHAT YOU VALUE.

Introducing MEGAMOD: Tool sets built around what you need and want. Each set has been individually curated to contain the right tools for the job, organized in the most efficient way possible.

NEW MEGAMOD MASTER TECHNICIAN SETS
NOW FEATURING SETS WITH UP TO 1858 TOOLS



MEGAMOD 1858

1858 PIECE MASTER TECHNICIAN SET

- 1835 Tools
- 37 Premium Modular Trays
- 9 Storage Units
- 14 Workshop Products

Item No. APX MEGAMOD1858
\$30,000

MEGAMOD 1629

1629 PIECE MASTER TECHNICIAN SET

- 1610 Tools
- 34 Premium Modular Trays
- 5 Storage Units
- 14 Workshop Products

Item No. APX MEGAMOD1629
\$24,999

MEGAMOD 1331

1331 PIECE MASTER TECHNICIAN SET

- 1314 Tools
- 27 Premium Modular Trays
- 6 Storage Units
- 11 Workshop Products

Item No. APX MEGAMOD1331
\$14,999

ADDITIONAL MEGAMOD MASTER TECHNICIAN SETS

Item No.	Description	Price	Item No.	Description	Price
APX MEGAMOD1268	1268 Piece Master Technician Set	\$15,499	APX MEGAMODMRO	614 Piece Master Technician Set	\$4,299
APX MEGAMOD1024	1024 Piece Master Technician Set	\$9,499	APX MEGAMOD358	358 Piece Master Technician Set	\$2,149
APX MEGAMOD873	873 Piece Master Technician Set	\$6,999	APX MEGAMOD247	247 Piece Master Technician Set	\$1,999
APX MEGAMODPRO	791 Piece Master Technician Set	\$4,799	APX MEGAMOD194	194 Piece Master Technician Set	\$999

HI-VIZ SOCKET & WRENCH MODULAR SETS

MULTI-PIECE ASSORTMENTS IN FOAM STORAGE TRAYS

Item No.	Description	Price
APX GWMSISKHMM	NEW 68 Piece 3/8" and 1/2" Drive 6 Point Metric, Standard & Deep, Hi-Viz Impact Socket Set	\$379.99
APX GWMSISKHSAE	NEW 54 Piece 3/8" and 1/2" Drive 6 Point SAE, Standard & Deep, Hi-Viz Impact Socket Set	\$379.99
APX GWMSKTHMM	NEW 74 Piece 1/4", 3/8", 1/2" Drive Hi-Viz 6 Point, Standard & Deep, Metric Chrome Socket Set	\$349.99
APX GWMSKTHSAE	NEW 63 Piece 1/4", 3/8", 1/2" Drive Hi-Viz 6 Point, Standard & Deep, SAE Chrome Socket Set	\$329.99
APX GWMSSWHMM	NEW 24 Piece Hi-Viz 12 Point Long Beam Combination Metric Wrench Set	\$329.99
APX GWMSSWHSAE	NEW 19 Piece Hi-Viz 12 Point Long Beam Combination SAE Wrench Set	\$314.99



NEW GWMSISKHSAE



NEW GWMSWHSAE

ADDITIONAL MODULAR SETS IN FOAM STORAGE TRAYS

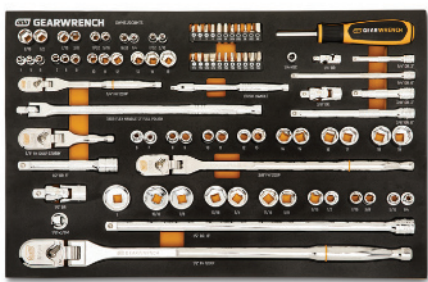

NEW GWMS120CBMTS



NEW GWH5PCMS



GWMSMBS02



GWMSPLR01

Item No.	Description	Price
APX GWMS120CBMTS	NEW 89 Piece 120XP™ Mechanics Tool Set	\$379.99
APX GWH5PCMS	NEW 5 Piece Mixed Hammer Set in Foam Storage Tray	\$124.99
APX 86521	21 Piece 3/8" 90-Tooth Ratchet & Drive Tool Set with Foam Storage Tray	\$249.99
APX 86529	83 Piece 1/4", 3/8" & 1/2" Drive 90-Tooth SAE/Metric Mechanics Tool Set	\$379
APX GWMSBBS02	97 Piece 1/4", 3/8", 1/2" Drive Bolt Biter™ Mechanics Tool Set	\$679.99
APX GWMSBSCBMM	74 Piece 1/4", 3/8" & 1/2" Drive Metric Bit Socket Set	\$369.99
APX GWMSBSCBSAE	88 Piece 1/4", 3/8", 1/2" Drive SAE Bit Socket Set	\$369.99
APX GWMSCWL12MM	24 Piece 12 Point Long Pattern Combination Metric Wrench Set	\$299.99
APX GWMSCWL12SAE	19 Piece 12 Point Long Pattern Combination SAE Wrench Set	\$299.99
APX GWMSISKMM	66 Piece 1/4", 3/8", 1/2" Drive 6 Point Metric Impact Socket Set	\$279.99
APX GWMSISKSAE	63 Piece 1/4", 3/8", 1/2" Drive 6 Point SAE Impact Socket Set	\$269.99
APX GWMSMBS01	105 Piece 1/4" Drive Slim Head Mechanics Tool Set	\$99.99

Item No.	Description	Price
APX GWMSMBS02	82 Piece 120XP™ Automotive Tool Set	\$249.99
APX GWMSPLR01	5 Piece PITBULL™ Cushion Grip Pliers Set	\$129.99
APX GWMSSCRPH	9 Piece Phillips® Dual Material Screwdriver Set	\$69.99
APX GWMSSCRSL	9 Piece Slotted Dual Material Screwdriver Set	\$79.99
APX GWMSSCRTX	10 Piece Torx® Dual Material Screwdriver Set	\$79.99
APX GWMSSKT12MM	67 Piece 1/2" Drive Master Metric Socket Set	\$259.99
APX GWMSSKT12SAE	60 Piece 1/2" Drive Master SAE Socket Set	\$319.99
APX GWMSSKT14MM	89 Piece 1/4" Drive Master Metric Socket Set	\$169.99
APX GWMSSKT14SAE	68 Piece 1/4" Dr Master SAE Socket Set	\$129.99
APX GWMSSKT38MM	104 Piece 3/8" Drive Master Metric Socket Set	\$269.99
APX GWMSSKT38SAE	85 Piece 3/8" Drive Master SAE Socket Set	\$269.99
APX GWMSRRWMM	20 Piece Specialty Ratcheting Metric Wrench Set	\$529.99
APX GWMSRRWSAE	19 Piece Specialty Ratcheting SAE Wrench Set	\$549.99

Homak



PROFESSIONAL SERVICE CARTS

16/18 GAUGE STEEL 100/200LBS DRAWER CAPACITY

- 100/200 lb. Capacity Ball-Bearing Slides
- Non-Slip PVC Foam Drawer Liners
- Contoured Aluminum Lift Latch Drawer Pulls
- Bold UV-Protective High Gloss Powder Coat Finish
- Heavy-Duty Comfort Grip Push Handle



DEDICATED CORDLESS TOOL DRAWER WITH POWER STRIP

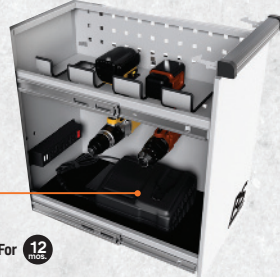

ROLLER CABINETS & CHESTS

16/18 GAUGE STEEL 100/200LBS DRAWER CAPACITY

- 660lbs Caster Capacity (Total 2640)
- 100/200 lb. Capacity Ball-Bearing Slides
- Bold UV-Protective High Gloss Powder Coat Finish
- Contoured Aluminum Lift Latch Drawer Pulls
- Non-Slip PVC Foam Drawer Liners
- Heavy-Duty Comfort Grip Push Handle

72" \$1,769 \$178.15 For 12
72" RS Pro 12 Drawer Top Chest w/ Power Strip
 TSS BK02072120 Midnight Black
 TSS BL02072120 Rally Sport Blue
 TSS RD02072120 Fury Red
 TSS LG02072120 Monster Green
 TSS OG02072120 Competition Orange

72" \$2,599 \$101.95 For 36
72" RS Pro 16 Drawer Roller Cabinet
 TSS BK04072160 Midnight Black
 TSS BL04072160 Rally Sport Blue
 TSS RD04072160 Fury Red
 TSS LG04072160 Monster Green
 TSS OG04072160 Competition Orange

44" \$1,669 \$168.08 For 12
44" RS Pro 8 Drawer Flip Top Power Service Cart
 TSS BK06044080 Midnight Black
 TSS BL06044080 Rally Sport Blue
 TSS RD06044080 Fury Red
 TSS GR06044080 Battleship Gray
 TSS WH06044080 Polar White

44" \$1,699 \$171.10 For 12
44" RS Pro 9 Drawer Flip Top Power Service Cart
 TSS BK06044090 Midnight Black
 TSS BL06044090 Rally Sport Blue
 TSS RD06044090 Fury Red
 TSS GR06044090 Battleship Gray
 TSS WH06044090 Polar White

LOCALLY KNOWN & TRUSTED PROFESSIONALLY Since 1947



54" \$1,349 \$135.85 For 12
54" RS Pro 8 Drawer Top Chest w/ Power Strip
 TSS BK02065800 Midnight Black
 TSS BL02065800 Rally Sport Blue
 TSS RD02065800 Fury Red
 TSS LG02065800 Monster Green
 TSS OG02065800 Competition Orange

54" \$1,949 \$106.97 For 24
54" RS Pro 10 Drawer Roller Cabinet
 TSS BK04054010 Midnight Black
 TSS BL04054010 Rally Sport Blue
 TSS RD04054010 Fury Red
 TSS LG04054010 Monster Green
 TSS OG04054010 Competition Orange

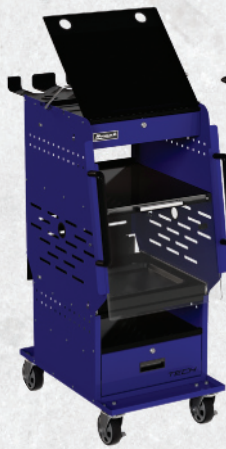

35" \$1,149 \$115.71 For 12
35" RS Pro 7 Drawer Flip Top Service Cart
 TSS BK06035247 Midnight Black
 TSS BL06035247 Rally Sport Blue
 TSS RD06035247 Fury Red
 TSS LG06035247 Monster Green
 TSS OG06035247 Competition Orange
 TSS GR06035247 Battleship Gray
 TSS WH06035247 Polar White
 TSS BC06035247 Black Cherry

35" \$799
35" 4 Drawer Slide Top Service Cart
 TSS BK06043500 Midnight Black
 TSS BL06043500 Rally Sport Blue
 TSS RD06043500 Fury Red

35" \$799
35" 4 Drawer Flip Top Service Cart
 TSS BK06032000 Midnight Black
 TSS BL06032000 Rally Sport Blue
 TSS RD06032000 Fury Red

\$569
TECH Mobile Diagnostic and Testing Terminal
 TSS BB06019020 Blue / Black
 • Adjustable Angled Monitor Surface
 • Pull-out Battery Shelf w/ Protective Shield
 • 2 Lockable Storage Drawers
 • Cordless Power Tool Holders
 • 4 264lb. (5"x2") Swivel Casters, 2 Locking
 • UV Protective High Gloss Finish



41" \$999
41" RS Pro 7 Drawer Top Chest w/ Power Strip
 TSS BK02004173 Midnight Black
 TSS BL02004173 Rally Sport Blue
 TSS RD02004173 Fury Red
 TSS LG02004173 Monster Green
 TSS OG02004173 Competition Orange

41" \$1,399 \$140.89 For 12
41" RS Pro 9 Drawer Roller Cabinet
 TSS BK04004193 Midnight Black
 TSS BL04004193 Rally Sport Blue
 TSS RD04004193 Fury Red
 TSS LG04004193 Monster Green
 TSS OG04004193 Competition Orange



ROLLING WORKSTATIONS WITH SS TOPS

16/18 GAUGE STEEL 100/200LBS DRAWER CAPACITY

- 660lbs Caster Capacity (Total 2640)
- 100/200 lb. Capacity Ball-Bearing Slides
- Contoured Aluminum Lift-Latch Drawer Pulls
- Bold UV-Protective High Gloss Powder Coat Finish
- Heavy-Duty Comfort Grip Push Handle
- Non-Slip PVC Foam Drawer Liners



72" \$2,699 \$105.88 For 36
72" RS Pro 16 Drawer Roller Cabinet w/ Stainless Steel Top 24" Depth
 TSS BK04072164 Midnight Black
 TSS BL04072164 Rally Sport Blue
 TSS RD04072164 Fury Red
 TSS LG04072164 Monster Green
 TSS OG04072164 Competition Orange



54" \$1,999 \$109.71 For 24
54" RS Pro 10 Drawer Roller Cabinet w/ Stainless Steel Top 24" Depth
 TSS BK04054014 Midnight Black
 TSS BL04054014 Rally Sport Blue
 TSS RD04054014 Fury Red
 TSS LG04054014 Monster Green
 TSS OG04054014 Competition Orange
 TSS GR04054014 Battleship Gray



54" \$1,699 \$171.10 For 12
54" TECH Workstation with Power Drawer & Stainless Steel Top
 TSS BK04054070 Midnight Black
 TSS BL04054070 Rally Sport Blue
 TSS RD04054070 Fury Red
 TSS GR04054070 Battleship Gray

120" \$7,998 \$194.45 For 60
120" RS Pro CTS Combo w/ Toolboard Backsplash
 TSS BKCTS12002 Midnight Black
 TSS BLCTS12002 Rally Sport Blue
 TSS RDCTS12002 Fury Red

120" \$7,998 \$194.45 For 60
120" RS Pro CTS Combo w/ Solid Backsplash
 TSS BKCTS12001 Midnight Black
 TSS BLCTS12001 Rally Sport Blue
 TSS RDCTS12001 Fury Red

10 FEET OF TOOL STORAGE

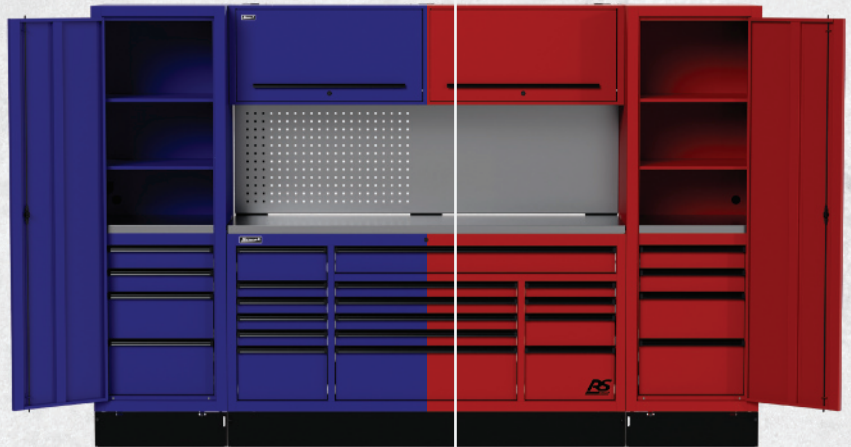

Includes 72" RS Pro Roller Cabinet, Hanging Canopy, Stainless Steel Top and Backsplash, and (2) 24" CTS Side Lockers w/ Power Strips

- 660lbs Caster Capacity (Total 5280)
- 24 Drawers with PVC Foam Liners
- 100/200 lb. Capacity Ball-Bearing Slides
- Contoured Aluminum Lift-Latch Drawer Pulls
- Bold UV-Protective High Gloss Powder Coat Finish
- Two (2) Overhead Storage Compartments
- Choice of Solid or Toolboard Backsplash
- Choice of Casters or Adjustable Feet



REAL DEALS



NAPA NETWORK SCHOLARSHIP PROGRAM

Help Steer Bright Futures
In The Right Direction

BENEFITS:

Empower the next generation, be the champion your community needs.

Let TechForce handle scholarship management while you gain local visibility.

Join now with a low \$2,500 contribution; all fees are covered by NAPA corporate.



Scan QR Code To Sign Up

© 2026 National Automotive Parts Association LLC

NAPA MERCHANDISE POLICY

Prices are subject to change without notice.

Regular prices shown are manufacturer's suggested retail prices at time of printing. We reserve the right to limit quantities and to correct pricing errors. Some new items might not be available at the time of print deadline. Contact your local NAPA AUTO PARTS store for pricing and availability. Program good at participating locations only. The Commodore Financial Equipment Financing Program is available to businesses only. See your participating NAPA AUTO PARTS store for details, or visit www.CommodoreFinancial.com. Qualifications subject to credit approval. Applicable taxes to be added. Monthly payment estimates reflect "NO MONEY DOWN and 30 DAYS NO PAYMENTS" with a \$1 buyout at agreement end. Terms, conditions and prices vary for businesses less than 3 years old. Terms, conditions and prices vary in Arkansas. Additional freight charges may be required for shipments to Hawaii and Alaska. Some items may have to be special ordered from Hawaii and Alaska Distribution Centers. Prices may vary in Alaska, Hawaii and Mexico. Other restrictions may apply. Some chemicals not available in California. © 2026 National Automotive Parts Association LLC. ALL RIGHTS RESERVED.