



ADVANTAGE

ALL ALUMI-GUARD PRODUCTS ARE MANUFACTURED
WITH PRIDE IN THE UNITED STATES OF AMERICA 

ADVANTAGE

*"One of The Top Finishing Shops in North America,"
for four consecutive years!*

~ Products Finishing Magazine



ALUMI-GUARD®

Our large selection of maintenance-free fence, railing, and gates are made to withstand some of the harshest conditions. Manufactured in a state-of-the-art facility in Brooksville, Florida, Alumi-Guard® products are available in all fifty states and Canada.

Everything we produce - including all panels, posts, and gates - are made right here at home. So know that when you choose an Alumi-Guard product, you're also choosing an American company that manufactures quality, American made products.



ALL ALUMI-GUARD® PRODUCTS ARE
MANUFACTURED IN THE UNITED STATES OF AMERICA

SUPERIOR POWDER COATED STRENGTH

Platinum Certified Applicator - Surpasses 10,000 Hours Salt Spray Test
Meets or Exceeds AAMA 2604-13 Specifications

CUTTING-EDGE TECHNOLOGY & UNMATCHED SERVICE & SUPPORT

Customer Service, Engineering and Architect Services Departments

LIMITED LIFETIME WARRANTY



Protecting what you love

ALUMI-GUARD.COM

ADVANTAGES

- U-FRAME GATES
- BEVELED RAILS FOR ADDED STRENGTH
- ECO-CONSCIOUS COMPANY
- EARN LEED POINTS
- CUSTOM SERVICES
- QUICKSHIP COLLECTION PROGRAM

SIX UNIQUE GRADES

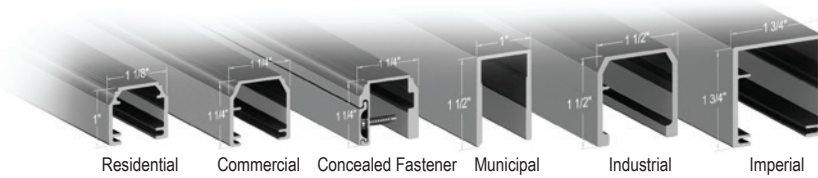

SEVEN RICH POWDER COATED COLORS

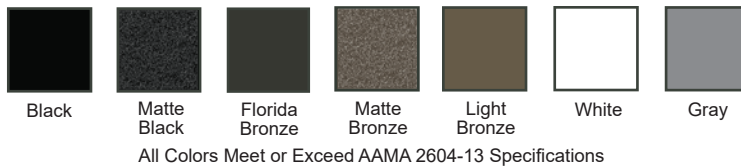

ALUMI-GUARD® ADVANTAGES

Made in the USA - Available Nationwide Manufactured in a state-of-the art facility located in Brooksville, FL	✓
Platinum Certified Applicator We are a certified applicator for three of the largest international coating manufacturers	✓
Superior Powder Coated Strength Withstands the harshest of conditions Surpasses 10,000 hours Salt Spray Test (ASTM B-117) Meets or exceeds AAMA 2604-13 specifications	✓
Exemplary Service Professional Engineering, Architect, and Customer Service Departments	✓
UL-325 Compliant Gates Available	✓
True Height Panels	✓
Long Product Lifecycle Durable, scratch resistant powder coating, maintenance free, 80% recycled Aluminum - doesn't rust like steel	✓
Seven Rich Powder Coated Colors Standard colors meet or exceed AAMA 2604-13 specifications Custom colors available	✓
Select Sizes Meet ICC Pool Code Specifications	✓
Eco-Conscious Environmentally Aware Company 100% Aluminum, Paper & Plastic Scrap is recycled 90% Evaporant coolant water recycled Less than 1% of powder waste annually Lean Manufacturing Facility Practices	✓
Earn LEED Points (V3) Construction Waste Mgmt, Recycled Content, Innovation in Design	✓
Strong and Durable Boerboel® Hardware Multiple options are available for all gates	✓
Custom Services Available	✓
QuickShip Collection Program	✓

TABLE OF CONTENTS

About Alumi-Guard®	2
Advantages	3
Flat Top	4
Pressed Spear	5
Premier	6
Enhancements (Radius and Custom)	7
Pedestrian Gates (Walk and Pool)	8
Estate Gates (Swing and Cantilever)	9
Security	10
Chain Link Cantilever	11
Guardrail	12
Handrail	13
Fortress	14
Chariot	15

Please contact us for additional information regarding our powder coating, sealed drawings and load capacities. We're also available for assistance with job specific drawings or custom specifications. If you have questions regarding fencing, gates, balcony style guardrail or ADA handrail, we would be happy to help guide you to the right product for your job.



2401 Corporate Blvd • Brooksville, FL 34604
Toll Free: 877-258-6448 • Office: 352-754-8555
Fax: 352-544-8442

FLAT TOP

STYLES

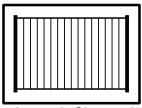

Ascot 2-Channel

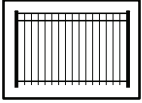

Ascot 3-Channel

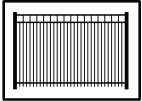

Ascot Royale

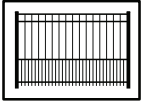

Ascot Puppy-Picket

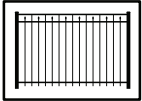

Canterbury

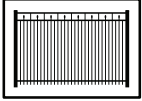

Canterbury Royale

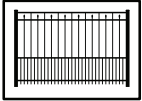

Canterbury Puppy-Picket

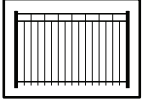

Fairmount

ASCOT • CANTEBURY • FAIRMOUNT

- Classic and Versatile
- Decorative
- Property Boundary
- 6 Unique Grades
- 7 Rich Colors
- True Height Panels



GRADES: CHANNELS & PICKETS

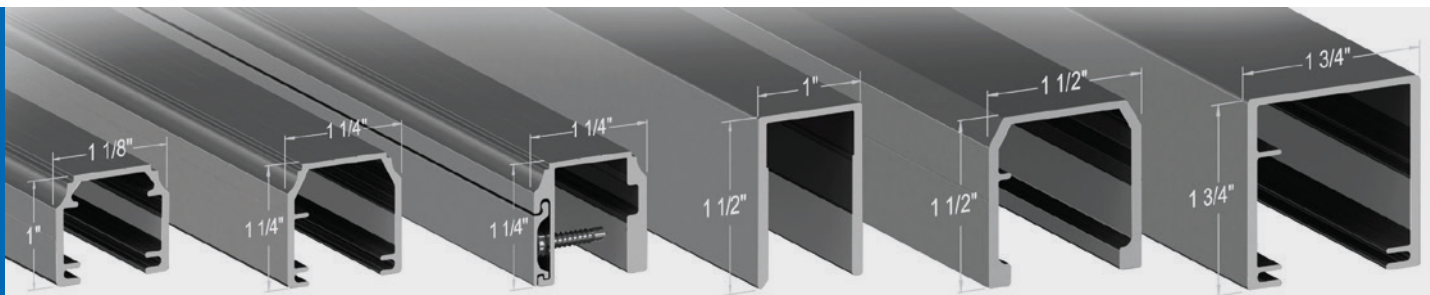

Residential

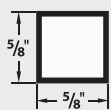

Commercial

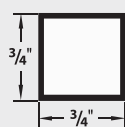

Concealed Fastener

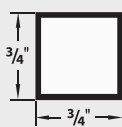

Municipal

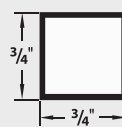

Industrial

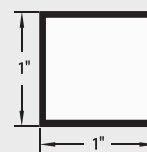

Imperial

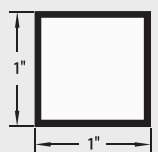

~ Channels & Pickets are shown at 3/5 actual size

PRESSED SPEAR

BELMONT • HAMILTON

- Aesthetic Security •
- Decorative •
- Deters Pedestrian Scaling •
- Perfect for Estates •
- 6 Unique Grades •
- 7 Rich Colors •
- True Height Panels •

STYLES

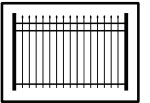

Belmont

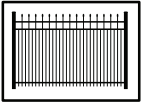

Belmont Royale

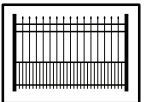

Belmont Puppy-Picket

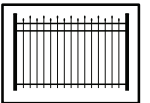

Hamilton

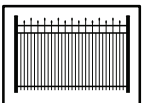

Hamilton Royale

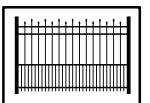

Hamilton Puppy-Picket



POSTS, ADORNMENTS & COLORS

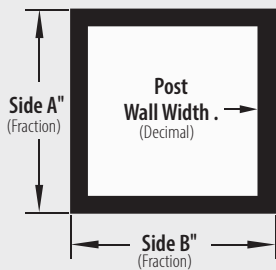

Post Measurements

2" x 2" x .062"	3" x 3" x .125"
2" x 2" x .093"	4" x 4" x .125"
2" x 2" x .125"	4" x 4" x .250"
2½" x 2½" x .075"	6" x 6" x .125"
2½" x 2½" x .125"	6" x 6" x .250"



~ Custom Colors Available

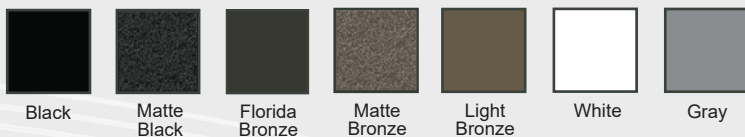

All Colors Meet or Exceed AAMA 2604-13 Specifications
*Guardrail not available in Matte Black and Matte Bronze



Protecting what you love

ALUMI-GUARD.COM

PREMIER

STYLES

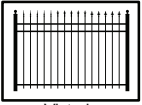

Victoria

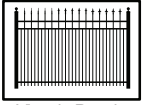

Victoria Royale

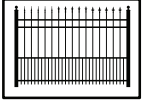

Victoria Puppy Picket

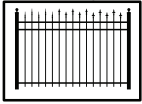

Victoria - Staggered

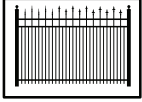

Staggered Royale

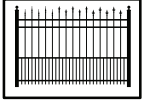

Staggered Puppy Picket

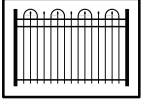

Newcastle I*

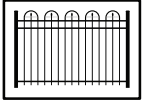

Newcastle II*

*Newcastle I & Newcastle II are Available in Residential Grade only.

VICTORIA NEWCASTLE I & • NEWCASTLE II

- Traditional, Old World Charm
- Decorative Safety Barrier
- Landscape Enhancing
- Ideal for Estates and Homes
- Quad, Triad, or Fleur-de-Lis Finials
- 6 Unique Grades
- 7 Rich Colors



GRADES: CHANNELS & PICKETS

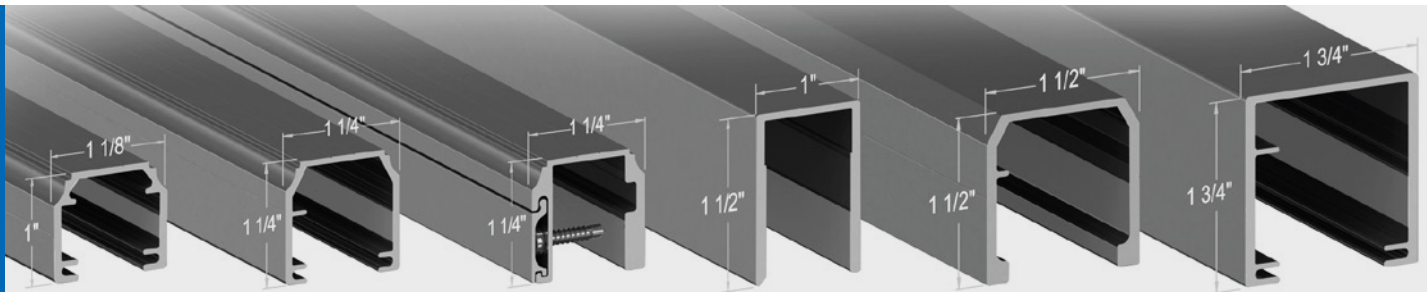

Residential

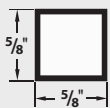

Commercial

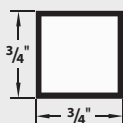

Concealed Fastener

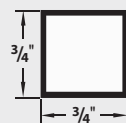

Municipal

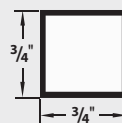

Industrial

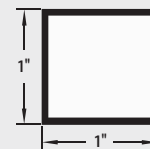

Imperial

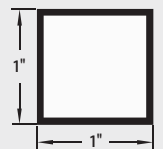

~ Channels & Pickets are shown at 3/5 actual size

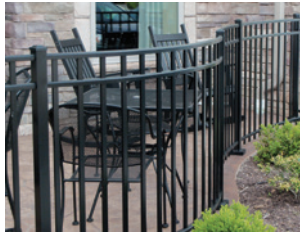

ENHANCEMENTS

RADIUS PANEL • CUSTOM SERVICES

- Custom Services Available
- Crafted by Skilled Artisans and Engineers
- Personalized and Individual
- 6 Unique Grades
- 7 Rich Colors
- Custom Colors Available
- Custom Radius Designs
- True Height Panels

STYLES

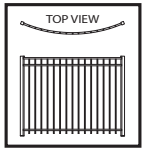

Radius Panels are available in all styles, heights, & Colors*
*Not Available in Concealed Fastener Grade



POSTS, ADORNMENTS & COLORS

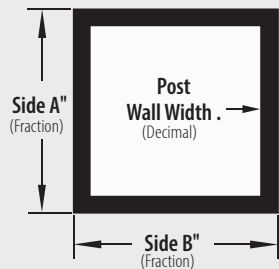

Post Measurements

2" x 2" x .062"	3" x 3" x .125"
2" x 2" x .093"	4" x 4" x .125"
2" x 2" x .125"	4" x 4" x .250"
2½" x 2½" x .075"	6" x 6" x .125"
2½" x 2½" x .125"	6" x 6" x .250"



~ Custom Colors Available

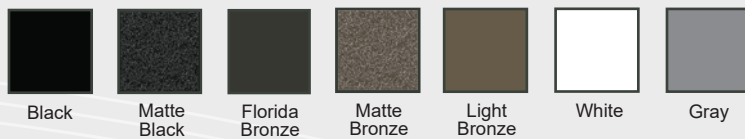

All Colors Meet or Exceed AAMA 2604-13 Specifications



Protecting what you love

ALUMI-GUARD.COM

PEDESTRIAN GATES

ARCHES



Arch 01 Series



Arch 02 Series



Arch 03 Series

WALK GATES • POOL GATES

- AAMA 2604-13 Compliant
- Powder Coating
- Complements Alumi-Guard® Fence
- Pool Code Latches Available
- Multiple Adornment Options
- 6 Unique Grades
- 7 Rich Colors
- True Height Panels



GRADES: CHANNELS, PICKETS & POSTS

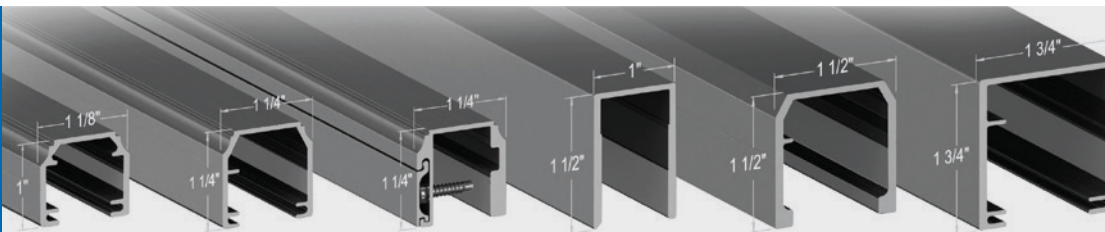

Residential



Commercial



Concealed Fastener

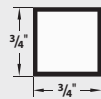

Municipal

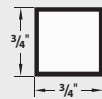

Industrial

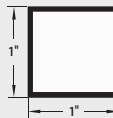

Imperial

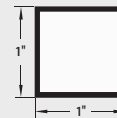

~ Channels & Pickets are shown at 2/5 actual size

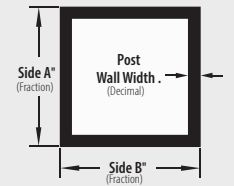

Post Measurements

2" x 2" x .062"	3" x 3" x .125"
2" x 2" x .093"	4" x 4" x .125"
2" x 2" x .125"	4" x 4" x .250"
2 1/2" x 2 1/2" x .075"	6" x 6" x .125"
2 1/2" x 2 1/2" x .125"	6" x 6" x .250"

ESTATE GATES

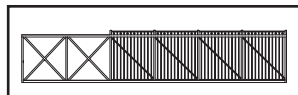

Arch 01 Series

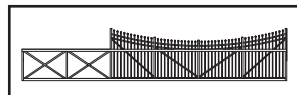

Arch 02 Series

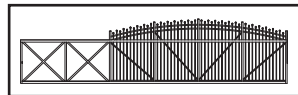

Arch 03 Series

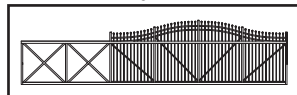

Arch 04 Series

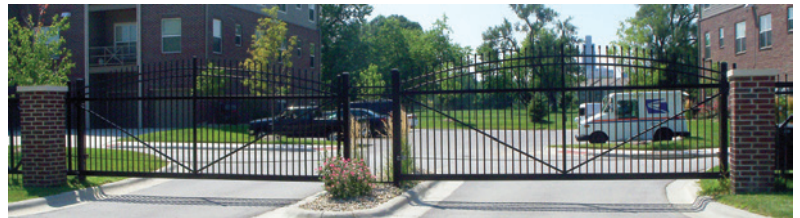

SWING GATES • CANTILEVER GATES

- Impressive, Elegant Functionality •
- Complements Alumi-Guard® Fence •
- Hardware Included •
- Upgraded Hardware Available •
- Custom Gate Options •
- 6 Unique Grades* •
- 7 Rich Colors •
- Beveled Rails For Strength •

ARCHES

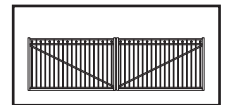

Arch 01 Series

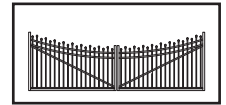

Arch 02 Series



Arch 03 Series

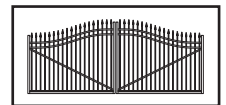

Arch 04 Series

HARDWARE & COLORS

Featuring Strong and Durable Boerboel® Hardware

Multiple options are available for all gates in addition to the selection shown below



BOERBOEL®
Gate Solutions



Wrap Hinge



GardDog® Locking Pool Latch



Butterfly Hinge



Gate Stop

~ Custom Colors Available



Black



Matte Black



Florida Bronze



Matte Bronze



Light Bronze



White



Gray

All Colors Meet or Exceed AAMA 2604-13 Specifications
*Sliding Cantilever or V-Groove Gates are available in all styles of Commercial, Municipal, Industrial and Imperial Grade Fence.

T-Slot Post attachment method eliminates unsightly u-bolts and bolt-throughs.

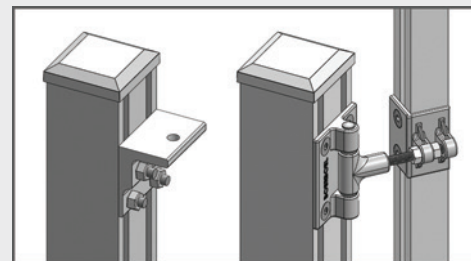

Protecting what you love

ALUMI-GUARD.COM

SECURITY

STYLES

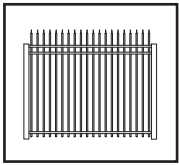

3 Channel

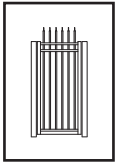

3 Channel
U-Frame Gate

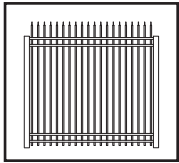

4 Channel

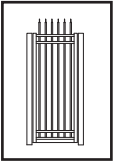

4 Channel
U-Frame Gate

3 & 4 CHANNEL STYLES MULTIPLE HEIGHTS & PANEL SIZES

- Achieves a High Level of Security
- Deterrent to Trespassers
- Industrial and Commercial Applications
- One of Our Heaviest Grades
- Withstands Above-Normal Abuse
- 7 Rich Colors
- U-Frame Gates
- Beveled Rails For Strength
- True Height Panels



GRADE: CHANNELS, PICKETS, POSTS & ADORNMENTS

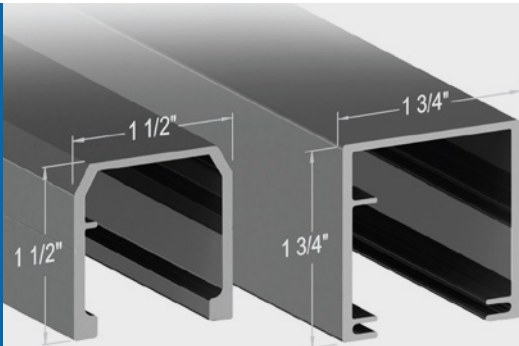

Security Grade

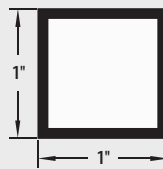

Security Picket

Post Measurements

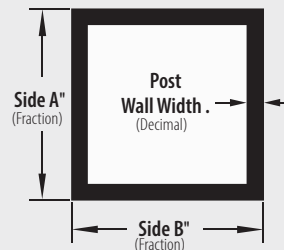

2½" x 2½" x .075"	4" x 4" x .125"
2½" x 2½" x .125"	4" x 4" x .250"
3" x 3" x .125"	6" x 6" x .125"
	6" x 6" x .250"



Security Grade Pressed Spear (Standard) Standard Post Cap

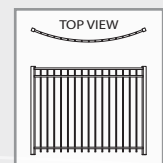

Radius Panel is Available in Security Grade

- ~ Security Grade comes standard with Industrial Grade channel. Imperial Grade channel is available as an upgrade.
- ~ Security Channel and Picket are shown at 3/5 actual size. Post image is a representation only.

CHAIN LINK CANTILEVER

SINGLE OR DOUBLE TRACK MULTIPLE HEIGHTS & LENGTHS

- Adds a High Level of Security
- Deters Trespassers
- Industrial and Commercial Applications
- Strong, Hand-Crafted Framework
- Chain Link, Wood, and Vinyl Inserts
- Optional Barbed Wire Top
- Superior Powder Coating Strength
- UL-325 Gates Available
- Multiple Track Options and Sizes
- 7 Rich Colors



STYLE EXAMPLES

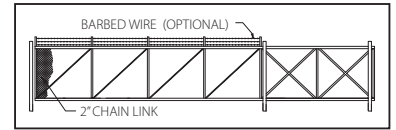

288" Cantilever • 6' Chain Link

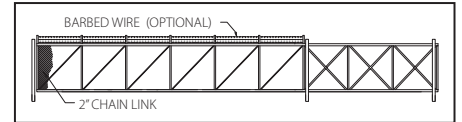

384" Cantilever • 6' Chain Link



DETAILS & COLORS

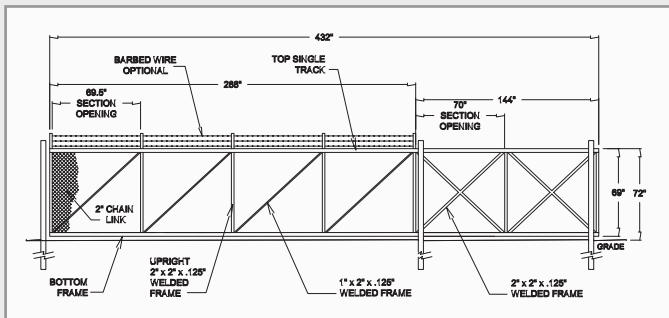

Chain Link Cantilever Gate
(Detailed Example)

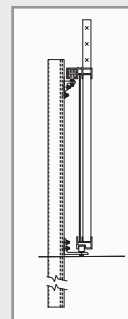

Track & Trolley
Assembly
(Single)

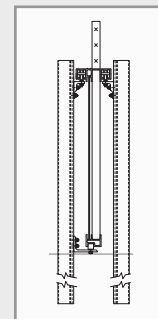

Track & Trolley
Assembly
(Double)

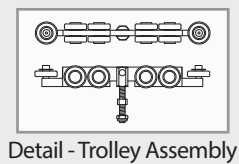

Detail - Trolley Assembly

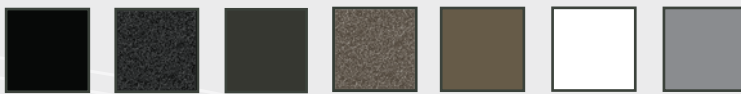

Black Matte Black Florida Bronze Matte Bronze Light Bronze White Gray

All Colors Meet or Exceed AAMA 2604-13 Specifications



Protecting what you love

ALUMI-GUARD.COM

GUARDRAIL

COMPONENTS

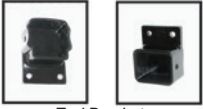

End Brackets



2 1/2" Intermediate Bracket



Vertical Swivel



Horizontal Swivel



Ball & Socket Swivel Bracket 2 1/2" - WRAP



Ball & Socket Swivel Bracket FLAT



Decorative End Cap



Bottom Rail Insert



2" & 2 1/2" Side Mount Flanges



- Complements a Variety of Architectural Styles
- Commercial and Residential Applications
- Meets Strict Safety Codes in All 50 States
- Can be Configured to Meet the 45" Spacing Required by ICC Pool Code
- Durable and Easy to Install
- Available in Multiple Heights
- Optional Adornments
- 5 Rich Colors



POSTS, PICKET & DETAILS

End Post
2 1/2" x 2 1/2" x .125"

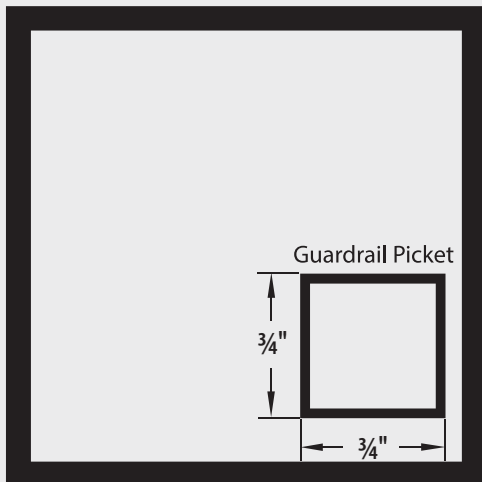

Guardrail Channels & Fasteners

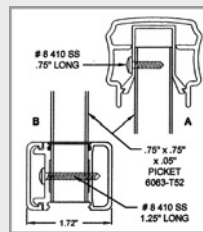

Intermediate Bracket

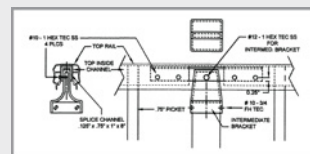

Guardrail Details

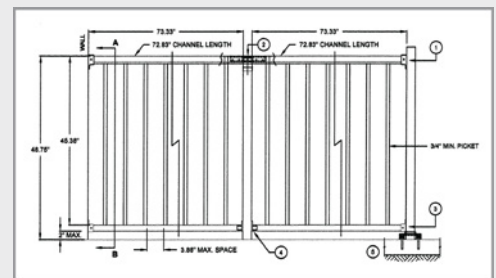

~ Railing Posts & Picket are shown actual size.

CHARIOT

TWO RAIL • THREE RAIL • FOUR RAIL

- Reminiscent of the Old Split-Rail Fence •
- Functional, Elegant and Simplistic •
- Excellent for Livestock Containment •
- Boundary Definition with a "Rural" Feel •
- Unobstructed View of Property •
- Superior Powder Coated Strength •
- 3 Styles Available in 8' Sections •
- 7 Rich, Long-Lasting Colors •
- Beveled Rails For Added Strength •

STYLES

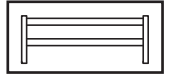

Chariot 2-Rail



2-Rail Gate

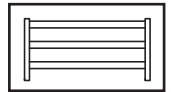

Chariot 3-Rail



3-Rail Gate

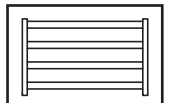

Chariot 4-Rail



4-Rail Gate

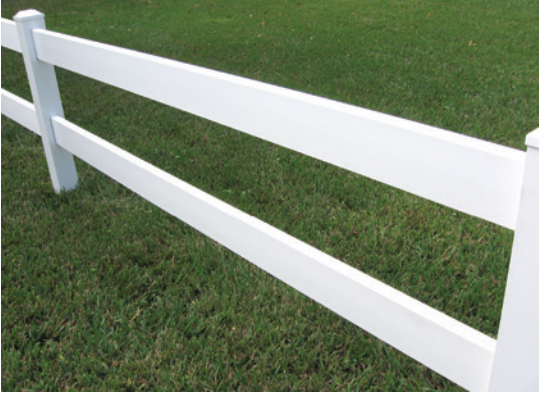

CHARIOT RAIL, POST & COLORS

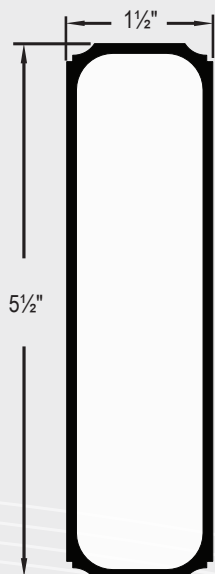

Chariot Horizontal Rail

Chariot Post
4" x 4"

COLORS



All Colors Meet or Exceed AAMA 2604-13 Specifications

Chariot Horizontal Rail & Chariot Post are shown at approximately 1/2 actual size



Protecting what you love

ALUMI-GUARD.COM

ALUMI-GUARD.COM



Industrial Grade • Belmont
Four Channel • White



Your Local Authorized Alumi-Guard Dealer

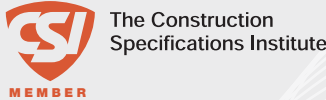

ALUMI-GUARD.COM